



# **A** A Series™ Contacts

## Machined and Stamped & Formed Contact Options

Amphenol Sine Systems is your trusted component source for precision connector contacts designed for increased reliability and reduced cost. Our **A Series™ Contacts** are readily available in a wide variety of materials and plating combinations and can be supplied with a number of different contact types. Also available are sealing plug and keying pin variations.

### Machined Contacts

Designed for heavy duty applications, these solid contacts will accommodate greater wire sizes

- Wire Size Range: 4AWG to 30AWG
- Available in Size 4, 8, 12, 16 and 20, in both Pin and Socket
- Current Ratings up to 100A
- Copper Alloy, Nickel-Plated
- Gold plating options available



### Stamped & Formed Contacts

Precision engineered stamped & formed design provides cost effective wire processing, while ensuring high reliability conductor termination and performance

- Wire Size Range: 10AWG to 30AWG
- Available in Size 12, 16 and 20, in both Pin and Socket
- Current Ratings up to 25A
- Copper Alloy, Nickel-Plated
- Gold and Tin plating options available
- Available in Loose Piece (-LP) Bag Packaging



Contact Crimp Specifications [can be found on pgs 10-11](#)

Application Specifications for Stamped & Formed Contacts [can be found on pgs 12-17](#)

## **A** A Series™ Family

### Heavy Duty, Multi-Pin Plastic and Metal Connectors

Amphenol Sine Systems' **A Series™ Family** of sealed, heavy-duty, multi-pin plastic and metal connectors is made up of 20+ core product lines serving many industries and bridges the gap between controlled and harsh environmental conditions to keep you connected. The connectors were developed as a high-performance, cost-effective solution for use with Heavy Equipment, Agricultural, Automotive, Military, Alternate Energy, and other demanding interconnect architectures.

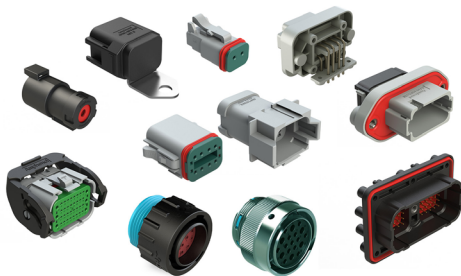

Standard products. Custom solutions  
Customer Service +1 800 394 7732

A Series™ Contacts - Machined

Note: Machined Crimp Specifications can be found on pgs 10-11.

Part Number	Type	Style	Contact Size	Amp	Wire Range AWG	Wire Range mm <sup>2</sup>	Insulation OD mm	Plating	Packaging
SC000384-8	Pin	Machined	Size 8mm	180A	-	50mm <sup>2</sup>	-	Gold-Plated	
SC000384-8-M1	Pin	Machined	Size 8mm	180A	-	50mm <sup>2</sup>	-	Gold-Plated	
SC000500-835	Pin	Machined	Size 8mm	180A	-	35mm <sup>2</sup>	-	Nickel-Plated	
SC000500-850	Pin	Machined	Size 8mm	180A	-	50mm <sup>2</sup>	-	Nickel-Plated	
SC000511	Pin	Machined	Size 8mm	180A	-	-	-	Gold-Plated	
AT60-203-04141-4	Pin	Machined	Size 4	100A	4AWG	-	-	Nickel-Plated	Bag (500 PCS)
AT60-203-0431-4	Pin	Machined	Size 4	100A	4AWG	-	-	Gold-Plated	
AT60-204-0490	Pin	Machined	Size 4	100A	6AWG	-	-	Nickel-Plated	Bag (500 PCS)
SC000345	Pin	Machined	Size 8	80A	7-10AWG	-	-	Silver-Plated	Bag (1000 PCS)
SC000345-141	Pin	Machined	Size 8	60A	7-10AWG	-	-	Nickel-Plated	Bag (150 PCS)
AT60-204-08141-16	Pin	Machined	Size 8	60A	6AWG	-	-	Nickel-Plated	Bag (500 PCS)
AT60-204-08141	Pin	Machined	Size 8	60A	8-10AWG	-	-	Nickel-Plated	Bag (500 PCS)
MP10B23T	Pin	Machined	Size 2.5mm	35A	10-12AWG	-	-	Tin-Plated	Bag (1000 PCS)
MP10B23S	Pin	Machined	Size 2.5mm	35A	10-12AWG	-	-	Silver-Plated	Bag (1000 PCS)
MP10B23F	Pin	Machined	Size 2.5mm	35A	10-12AWG	-	-	Gold Flash	Bag (1000 PCS)
MP10B23G5	Pin	Machined	Size 2.5mm	35A	10-12AWG	-	-	Gold 5µ" Flash	Bag (1000 PCS)
MP10B23G10	Pin	Machined	Size 2.5mm	35A	10-12AWG	-	-	Gold 10µ" Flash	Bag (1000 PCS)
MP10B23G15	Pin	Machined	Size 2.5mm	35A	10-12AWG	-	-	Gold 15µ" Flash	Bag (1000 PCS)
MS10B23G30	Pin	Machined	Size 2.5mm	35A	10-12AWG	-	-	Gold 30µ" Flash	Bag (1000 PCS)
SC000892F-10 (ATPH Only)	Pin	Machined	Size 10 (3.0mm)	30A	10-12AWG	6.0-4.0mm <sup>2</sup>	-	Gold-plated	Box (250 PCS)
SC000892F-14 (ATPH Only)	Pin	Machined	Size 10 (3.0mm)	30A	12-14AWG	4.0-2.0mm <sup>2</sup>	-	Gold-plated	Box (250 PCS)
SC000892S-10 (ATPH Only)	Pin	Machined	Size 10 (3.0mm)	30A	10-12AWG	6.0-4.0mm <sup>2</sup>	-	Silver-plated	Box (250 PCS)
SC000892S-14 (ATPH Only)	Pin	Machined	Size 10 (3.0mm)	30A	12-14AWG	4.0-2.0mm <sup>2</sup>	-	Silver-plated	Box (250 PCS)
AT60-204-12141-10	Pin	Machined	Size 12	25A	10-12AWG	-	-	Nickel-Plated	Box (500 PCS)
AT60-204-12141	Pin	Machined	Size 12	25A	12-14AWG	-	-	Nickel-Plated	X (2000 PCS)
AT60-220-1231	Pin	Machined	Size 12	25A	12-14AWG	-	-	Gold-Plated	X (5000 PCS)
AT60-204-12NKIT	Pin	Machined	Size 12	25A	12-14AWG	-	-	Nickel-Plated	Bag (10 PCS)
AT60-220-1231-1618	Pin	Machined	Size 12	25A	16-18AWG	-	-	Gold-Plated	
AT60-220-1231-1820	Pin	Machined	Size 12	25A	18-20AWG	-	-	Gold-Plated	
AT60-215-16141	Pin	Machined	Size 16	13A	14AWG	-	-	Nickel-Plated	X (5000 PCS)
AT60-215-1631	Pin	Machined	Size 16	13A	14AWG	-	-	Gold-Plated	X (5000 PCS)
AT60-202-16NKIT	Pin	Machined	Size 16	13A	16-20AWG	-	-	Nickel-Plated	Bag (10 PCS)
AT60-202-16141	Pin	Machined	Size 16	13A	16-20AWG	-	-	Nickel-Plated	X (5000 PCS)
AT60-202-1631	Pin	Machined	Size 16	13A	16-20AWG	-	-	Gold-Plated	X (5000 PCS)
AT60-202-16141-22	Pin	Machined	Size 16	13A	22-24AWG	-	-	Nickel-Plated	Box (5000 PCS)
AT60-202-1631-22	Pin	Machined	Size 16	13A	22-24AWG	-	-	Gold-Plated	Box (5000 PCS)
AT60-010-20141	Pin	Machined	Size 20	7.5A	16-18AWG	-	-	Nickel-Plated	X (5000 PCS)
AT60-010-2031	Pin	Machined	Size 20	7.5A	16-18AWG	-	-	Gold-Plated	X (5000 PCS)
AT60-202-20NKIT	Pin	Machined	Size 20	7.5A	18-22AWG	-	-	Nickel-Plated	Bag (10 PCS)
AT60-202-20141	Pin	Machined	Size 20	7.5A	20-22AWG	-	-	Nickel-Plated	X (5000 PCS)
AT60-202-2031	Pin	Machined	Size 20	7.5A	20-22AWG	-	-	Gold-Plated	X (5000 PCS)
MP18W23F	Pin	Machined	Size 20	7.5A	18-20AWG	0.75-0.50mm <sup>2</sup>	-	Gold Flash	
MP18W23G10	Pin	Machined	Size 20	7.5A	18-20AWG	0.75-0.50mm <sup>2</sup>	-	Gold 10µ" Flash	
MP18W23G15	Pin	Machined	Size 20	7.5A	18-20AWG	0.75-0.50mm <sup>2</sup>	-	Gold 15µ" Flash	
MP18W23G30	Pin	Machined	Size 20	7.5A	18-20AWG	0.75-0.50mm <sup>2</sup>	-	Gold 30µ" Flash	
MP20W23F	Pin	Machined	Size 20	7.5A	20-22AWG	0.34-0.50mm <sup>2</sup>	-	Gold Flash	Bag (500 PCS)
MP20W23G5	Pin	Machined	Size 20	7.5A	20-22AWG	0.34-0.50mm <sup>2</sup>	-	Gold 5µ" Flash	Bag (500 PCS)
MP20W23G10	Pin	Machined	Size 20	7.5A	20-22AWG	0.34-0.50mm <sup>2</sup>	-	Gold 10µ" Flash	Bag (500 PCS)
MP20W23G15	Pin	Machined	Size 20	7.5A	20-22AWG	0.34-0.50mm <sup>2</sup>	-	Gold 15µ" Flash	Bag (500 PCS)
MP20W23G30	Pin	Machined	Size 20	7.5A	20-22AWG	0.34-0.50mm <sup>2</sup>	-	Gold 30µ" Flash	Bag (500 PCS)
MP24W23F	Pin	Machined	Size 20	7.5A	24-26AWG	0.14-0.25mm <sup>2</sup>	-	Gold Flash	Bag (500 PCS)

Part Number	Type	Style	Contact Size	Amp	Wire Range AWG	Wire Range mm <sup>2</sup>	Insulation OD mm	Plating	Packaging
MP24W23G5	Pin	Machined	Size 20	7.5A	24-26AWG	0.14-0.25mm <sup>2</sup>	-	Gold 5µ" Flash	Bag (500 PCS)
MP24W23G10	Pin	Machined	Size 20	7.5A	24-26AWG	0.14-0.25mm <sup>2</sup>	-	Gold 10µ" Flash	Bag (500 PCS)
MP24W23G15	Pin	Machined	Size 20	7.5A	24-26AWG	0.14-0.25mm <sup>2</sup>	-	Gold 15µ" Flash	Bag (500 PCS)
MP24W23G30	Pin	Machined	Size 20	7.5A	24-26AWG	0.14-0.25mm <sup>2</sup>	-	Gold 30µ" Flash	Bag (500 PCS)
MP28W23F	Pin	Machined	Size 20	7.5A	28-30AWG	0.05-0.08mm <sup>2</sup>	-	Gold Flash	Bag (500 PCS)
MP28W23G5	Pin	Machined	Size 20	7.5A	28-30AWG	0.05-0.08mm <sup>2</sup>	-	Gold 5µ" Flash	Bag (500 PCS)
MP28W23G10	Pin	Machined	Size 20	7.5A	28-30AWG	0.05-0.08mm <sup>2</sup>	-	Gold 10µ" Flash	Bag (500 PCS)
MP28W23G15	Pin	Machined	Size 20	7.5A	28-30AWG	0.05-0.08mm <sup>2</sup>	-	Gold 15µ" Flash	Bag (500 PCS)
MP28W23G30	Pin	Machined	Size 20	7.5A	28-30AWG	0.05-0.08mm <sup>2</sup>	-	Gold 30µ" Flash	Bag (500 PCS)
AT60-202-2031-22	Pin	Machined	Size 20	5A	22-26AWG	-	-	Gold-Plated	Bag (500 PCS)
AT60-202-20141-22	Pin	Machined	Size 20	5A	22-26AWG	-	-	Nickel-Plated	Bag (500 PCS)
SC000383-8	Socket	Machined	Size 8mm	180A	-	50mm <sup>2</sup>	-	Gold-Plated	
SC000445-8	Socket	Machined	Size 8mm	180A	-	50mm <sup>2</sup>	-	Nickel-Plated	
SC000501-835	Socket	Machined	Size 8mm	180A	-	35mm <sup>2</sup>	-	Nickel-Plated	
SC000501-850	Socket	Machined	Size 8mm	180A	-	50mm <sup>2</sup>	-	Nickel-Plated	
AT62-203-04141	Socket	Machined	Size 4	100A	6AWG	-	-	Nickel-Plated	Bag (500 PCS)
AT62-203-04141-4	Socket	Machined	Size 4	100A	4AWG	-	-	Nickel-Plated	X (500 PCS)
AT62-203-0431-4	Socket	Machined	Size 4	100A	4AWG	-	-	Gold-Plated	
SC000346	RADSOK® Socket	Machined	Size 8	80A	7-10AWG	-	-	Silver-Plated	Bag (1000 PCS)
SC000379	Socket	Machined	Size 8	60A	8-10AWG	-	-	Nickel-Plated	Bag (150 PCS)
AT62-203-08141-16	Socket	Machined	Size 8	60A	6AWG	-	-	Nickel-Plated	Bag (500 PCS)
AT62-203-08141	Socket	Machined	Size 8	60A	8-10AWG	-	-	Nickel-Plated	Bag (500 PCS)
MS10B23T	Socket	Machined	Size 2.5mm	35A	10-12AWG	-	-	Tin-Plated	Bag (1000 PCS)
MS10B23S	Socket	Machined	Size 2.5mm	35A	10-12AWG	-	-	Silver-Plated	Bag (1000 PCS)
MS10B23F	Socket	Machined	Size 2.5mm	35A	10-12AWG	-	-	Gold Flash	Bag (1000 PCS)
MS10B23G5	Socket	Machined	Size 2.5mm	35A	10-12AWG	-	-	Gold 5µ" Flash	Bag (1000 PCS)
MS10B23G10	Socket	Machined	Size 2.5mm	35A	10-12AWG	-	-	Gold 10µ" Flash	Bag (1000 PCS)
MS10B23G15	Socket	Machined	Size 2.5mm	35A	10-12AWG	-	-	Gold 15µ" Flash	Bag (1000 PCS)
MS10B23G30	Socket	Machined	Size 2.5mm	35A	10-12AWG	-	-	Gold 30µ" Flash	Bag (1000 PCS)
SC000893F-10 (ATPH Only)	Socket	Machined	Size 10 (3.0mm)	30A	10-12AWG	6.0-4.0mm <sup>2</sup>	-	Gold-plated	Box (250 PCS)
SC000893F-14 (ATPH Only)	Socket	Machined	Size 10 (3.0mm)	30A	12-14AWG	4.0-2.0mm <sup>2</sup>	-	Gold-plated	Box (250 PCS)
SC000893S-10 (ATPH Only)	Socket	Machined	Size 10 (3.0mm)	30A	10-12AWG	6.0-4.0mm <sup>2</sup>	-	Silver-plated	Box (250 PCS)
SC000893S-14 (ATPH Only)	Socket	Machined	Size 10 (3.0mm)	30A	12-14AWG	4.0-2.0mm <sup>2</sup>	-	Silver-plated	Box (250 PCS)
AT62-203-12141-10	Socket	Machined	Size 12	25A	10-12AWG	-	-	Nickel-Plated	Box (500 PCS)
AT62-203-12141	Socket	Machined	Size 12	25A	12-14AWG	-	-	Nickel-Plated	X (2000 PCS)
AT62-203-12NKIT	Socket	Machined	Size 12	25A	12-14AWG	-	-	Nickel-Plated	Bag (10 PCS)
AT62-210-1231	Socket	Machined	Size 12	25A	12-14AWG	-	-	Gold-Plated	X (5000 PCS)
AT62-210-1231-1618	Socket	Machined	Size 12	25A	16-18AWG	-	-	Gold-Plated	
AT62-210-1231-1820	Socket	Machined	Size 12	25A	18-20AWG	-	-	Gold-Plated	Box (500 PCS)
AT62-209-16141	Socket	Machined	Size 16	13A	14AWG	-	-	Nickel-Plated	X (5000 PCS)
AT62-209-1631	Socket	Machined	Size 16	13A	14AWG	-	-	Gold-Plated	X (5000 PCS)
AT62-201-16NKIT	Socket	Machined	Size 16	13A	16-20AWG	-	-	Nickel-Plated	Bag (10 PCS)
AT62-201-16141	Socket	Machined	Size 16	13A	16-20AWG	-	-	Nickel-Plated	X (5000 PCS)
AT62-201-1631	Socket	Machined	Size 16	13A	16-20AWG	-	-	Gold-Plated	X (5000 PCS)
AT62-201-16141-22	Socket	Machined	Size 16	13A	22-24AWG	-	-	Nickel-Plated	Box (5000 PCS)
AT62-201-1631-22	Socket	Machined	Size 16	13A	22-24AWG	-	-	Gold-Plated	Box (5000 PCS)
AT62-005-20141	Socket	Machined	Size 20	7.5A	16-18AWG	-	-	Nickel-Plated	X (5000 PCS)
AT62-005-2031	Socket	Machined	Size 20	7.5A	16-18AWG	-	-	Gold-Plated	X (5000 PCS)
AT62-201-20NKIT	Socket	Machined	Size 20	7.5A	20-22AWG	-	-	Nickel-Plated	Bag (10 PCS)
AT62-201-20141	Socket	Machined	Size 20	7.5A	20-22AWG	-	-	Nickel-Plated	X (5000 PCS)
AT62-201-2031	Socket	Machined	Size 20	7.5A	20-22AWG	-	-	Gold-Plated	X (5000 PCS)
AT62-20-0422	Socket	Machined	Size 20	7.5A	20-22AWG	-	-	Nickel-Plated	

Part Number	Type	Style	Contact Size	Amp	Wire Range AWG	Wire Range mm <sup>2</sup>	Insulation OD mm	Plating	Packaging
AT62-20-0444	Socket	Machined	Size 20	7.5A	20-22AWG	-	-	Gold-Plated	
MS18W23F	Socket	Machined	Size 20	7.5A	18-20AWG	0.75-0.50mm <sup>2</sup>	-	Gold Flash	
MS18W23G10	Socket	Machined	Size 20	7.5A	18-20AWG	0.75-0.50mm <sup>2</sup>	-	Gold 10µ" Flash	
MS18W23G15	Socket	Machined	Size 20	7.5A	18-20AWG	0.75-0.50mm <sup>2</sup>	-	Gold 15µ" Flash	
MS18W23G30	Socket	Machined	Size 20	7.5A	18-20AWG	0.75-0.50mm <sup>2</sup>	-	Gold 30µ" Flash	
MS20W23T	Socket	Machined	Size 20	7.5A	18-20AWG	0.75-0.50mm <sup>2</sup>	-	Tin-Plated	
MS20W23S	Socket	Machined	Size 20	7.5A	18-20AWG	0.75-0.50mm <sup>2</sup>	-	Silver-Plated	
MS20W23F	Socket	Machined	Size 20	7.5A	20-22AWG	0.34-0.50mm <sup>2</sup>	-	Gold Flash	Bag (500 PCS)
MS20W23G5	Socket	Machined	Size 20	7.5A	20-22AWG	0.34-0.50mm <sup>2</sup>	-	Gold 5µ" Flash	Bag (500 PCS)
MS20W23G10	Socket	Machined	Size 20	7.5A	20-22AWG	0.34-0.50mm <sup>2</sup>	-	Gold 10µ" Flash	Bag (500 PCS)
MS20W23G15	Socket	Machined	Size 20	7.5A	20-22AWG	0.34-0.50mm <sup>2</sup>	-	Gold 15µ" Flash	Bag (500 PCS)
MS20W23G30	Socket	Machined	Size 20	7.5A	20-22AWG	0.34-0.50mm <sup>2</sup>	-	Gold 30µ" Flash	Bag (500 PCS)
MS24W23T	Socket	Machined	Size 20	7.5A	24-26AWG	0.14-0.25mm <sup>2</sup>	-	Tin-Plated	
MS24W23S	Socket	Machined	Size 20	7.5A	24-26AWG	0.14-0.25mm <sup>2</sup>	-	Silver-Plated	
MS24W23F	Socket	Machined	Size 20	7.5A	24-26AWG	0.14-0.25mm <sup>2</sup>	-	Gold Flash	Bag (500 PCS)
MS24W23G5	Socket	Machined	Size 20	7.5A	24-26AWG	0.14-0.25mm <sup>2</sup>	-	Gold 5µ" Flash	Bag (500 PCS)
MS24W23G10	Socket	Machined	Size 20	7.5A	24-26AWG	0.14-0.25mm <sup>2</sup>	-	Gold 10µ" Flash	Bag (500 PCS)
MS24W23G15	Socket	Machined	Size 20	7.5A	24-26AWG	0.14-0.25mm <sup>2</sup>	-	Gold 15µ" Flash	Bag (500 PCS)
MS24W23G30	Socket	Machined	Size 20	7.5A	24-26AWG	0.14-0.25mm <sup>2</sup>	-	Gold 30µ" Flash	Bag (500 PCS)
MS28W23F	Socket	Machined	Size 20	7.5A	28-30AWG	0.05-0.08mm <sup>2</sup>	-	Gold Flash	Bag (500 PCS)
MS28W23G5	Socket	Machined	Size 20	7.5A	28-30AWG	0.05-0.08mm <sup>2</sup>	-	Gold 5µ" Flash	Bag (500 PCS)
MS28W23G10	Socket	Machined	Size 20	7.5A	28-30AWG	0.05-0.08mm <sup>2</sup>	-	Gold 10µ" Flash	Bag (500 PCS)
MS28W23G15	Socket	Machined	Size 20	7.5A	28-30AWG	0.05-0.08mm <sup>2</sup>	-	Gold 15µ" Flash	Bag (500 PCS)
MS28W23G30	Socket	Machined	Size 20	7.5A	28-30AWG	0.05-0.08mm <sup>2</sup>	-	Gold 30µ" Flash	Bag (500 PCS)
AT62-201-2031-22	Socket	Machined	Size 20	5A	22-26AWG	-	-	Gold-Plated	Bag (500 PCS)
AT62-201-20141-22	Socket	Machined	Size 20	5A	22-26AWG	-	-	Nickel-Plated	Bag (500 PCS)

A Series™ Contacts - Stamped & Formed

**Note:** [Stamped & Formed Crimp Specifications can be found on pgs 10-11.](#)

Part Number	Type	Style	Contact Size	Amp	Wire Range AWG	Wire Range mm <sup>2</sup>	Insulation OD mm	Plating	Packaging
AT60-12-0222	Pin	S&F	Size 12	25A	10-12AWG	6.0-4.0mm <sup>2</sup>	3.56 - 5.18mm	Nickel-Plated	Reel (2000 PCS)
AT60-12-0222-LP	Pin	S&F	Size 12	25A	10-12AWG	6.0-4.0mm <sup>2</sup>	3.56 - 5.18mm	Nickel-Plated	Bag (50 PCS)
AT60-12-0244	Pin	S&F	Size 12	25A	10-12AWG	6.0-4.0mm <sup>2</sup>	3.56 - 5.18mm	Gold-Plated	Reel (2000 PCS)
AT60-12-0244-LP	Pin	S&F	Size 12	25A	10-12AWG	6.0-4.0mm <sup>2</sup>	3.56 - 5.18mm	Gold-Plated	Bag (50 PCS)
AT60-12-0144	Pin	S&F	Size 12	25A	12-14AWG	4.0-2.0mm <sup>2</sup>	2.87 - 4.47mm	Gold-Plated	Reel (2000 PCS)
AT60-12-0144-LP	Pin	S&F	Size 12	25A	12-14AWG	4.0-2.0mm <sup>2</sup>	2.87 - 4.47mm	Gold-Plated	Bag (50 PCS)
AT60-12-0166	Pin	S&F	Size 12	25A	12-14AWG	4.0-2.0mm <sup>2</sup>	2.87 - 4.47mm	Nickel-Plated	Reel (2000 PCS)
AT60-12-0166-LP	Pin	S&F	Size 12	25A	12-14AWG	4.0-2.0mm <sup>2</sup>	2.87 - 4.47mm	Nickel-Plated	Reel (2000 PCS)
SP12A1T	Pin	S&F	Size 2.5mm	23A	12-14AWG	-	4.3mm	Tin-Plated	Reel (1000 PCS)
SP12A1T-10	Pin	S&F	Size 2.5mm	23A	-	4.0mm <sup>2</sup>	4.3mm	Tin-Plated	Reel (1000 PCS)
SP12A1F	Pin	S&F	Size 2.5mm	23A	12-14AWG	-	4.3mm	Gold Flash	Reel (1000 PCS)
SP12A1F-10	Pin	S&F	Size 2.5mm	23A	-	4.0mm <sup>2</sup>	4.3mm	Gold Flash	Reel (1000 PCS)
SP12A1G10	Pin	S&F	Size 2.5mm	23A	12-14AWG	-	4.3mm	Gold 10µ" Flash	Reel (1000 PCS)
SP12A1G10-10	Pin	S&F	Size 2.5mm	23A	-	4.0mm <sup>2</sup>	4.3mm	Gold 10µ" Flash	Reel (1000 PCS)
SP12A1G15	Pin	S&F	Size 2.5mm	23A	12-14AWG	-	4.3mm	Gold 15µ" Flash	Reel (1000 PCS)
SP12A1G15-10	Pin	S&F	Size 2.5mm	23A	-	4.0mm <sup>2</sup>	4.3mm	Gold 15µ" Flash	Reel (1000 PCS)
SP12A1G30	Pin	S&F	Size 2.5mm	23A	12-14AWG	-	4.3mm	Gold 30µ" Flash	Reel (1000 PCS)
SP12A1G30-10	Pin	S&F	Size 2.5mm	23A	-	4.0mm <sup>2</sup>	4.3mm	Gold 30µ" Flash	Reel (1000 PCS)
AT60-14-0122	Pin	S&F	Size 16	13A	14-18AWG	2.0-0.75mm <sup>2</sup>	2.40 - 3.81mm	Nickel-Plated	Reel (4000 PCS)
AT60-14-0122-LP	Pin	S&F	Size 16	13A	14-18AWG	2.0-0.75mm <sup>2</sup>	2.40 - 3.81mm	Nickel-Plated	Bag (50 PCS)
AT60-14-0144	Pin	S&F	Size 16	13A	14-18AWG	2.0-0.75mm <sup>2</sup>	2.40 - 3.81mm	Gold-Plated	Reel (4000 PCS)
AT60-14-0144-LP	Pin	S&F	Size 16	13A	14-18AWG	2.0-0.75mm <sup>2</sup>	2.40 - 3.81mm	Gold-Plated	Bag (50 PCS)

Part Number	Type	Style	Contact Size	Amp	Wire Range AWG	Wire Range mm <sup>2</sup>	Insulation OD mm	Plating	Packaging
AT60-16-0122	Pin	S&F	Size 16	13A	16-18AWG	1.5-0.75mm <sup>2</sup>	1.91 - 3.55mm	Nickel-Plated	Reel (4000 PCS)
AT60-16-0122-LP	Pin	S&F	Size 16	13A	16-18AWG	1.5-0.75mm <sup>2</sup>	1.91 - 3.55mm	Nickel-Plated	Bag (50 PCS)
AT60-16-0144	Pin	S&F	Size 16	13A	16-18AWG	1.5-0.75mm <sup>2</sup>	1.91 - 3.55mm	Gold-Plated	Reel (4000 PCS)
AT60-16-0144-LP	Pin	S&F	Size 16	13A	16-18AWG	1.5-0.75mm <sup>2</sup>	1.91 - 3.55mm	Gold-Plated	Bag (50 PCS)
AT60-16-0622	Pin	S&F	Size 16	13A	16-20AWG	1.0-0.5mm <sup>2</sup>	1.40 - 2.54mm	Nickel-Plated	Reel (4000 PCS)
AT60-16-0622-LP	Pin	S&F	Size 16	13A	16-20AWG	1.0-0.5mm <sup>2</sup>	1.40 - 2.54mm	Nickel-Plated	Bag (50 PCS)
AT60-16-0644	Pin	S&F	Size 16	13A	16-20AWG	1.0-0.5mm <sup>2</sup>	1.40 - 2.54mm	Gold-Plated	Reel (4000 PCS)
AT60-16-0644-LP	Pin	S&F	Size 16	13A	16-20AWG	1.0-0.5mm <sup>2</sup>	1.40 - 2.54mm	Gold-Plated	Bag (50 PCS)
AT60-16-0322	Pin	S&F	Size 16	13A	20-22AWG	0.5-0.35mm <sup>2</sup>	1.31 - 1.50mm	Nickel-Plated	Reel (4000 PCS)
AT60-16-0344	Pin	S&F	Size 16	13A	20-22AWG	0.5-0.35mm <sup>2</sup>	1.31 - 1.50mm	Gold-Plated	Reel (4000 PCS)
AT60-16-0377	Pin	S&F	Size 16	13A	20-22AWG	0.5-0.35mm <sup>2</sup>	1.31 - 1.50mm	Tin-Plated	Reel (4000 PCS)
AT60-16-0822	Pin	S&F	Size 16	13A	20-22AWG	0.5-0.35mm <sup>2</sup>	1.31 - 1.50mm	Nickel-Plated	Reel (4000 PCS)
AT60-16-0844	Pin	S&F	Size 16	13A	20-22AWG	0.5-0.35mm <sup>2</sup>	1.31 - 1.50mm	Gold-Plated	Reel (4000 PCS)
SP14M2T	3 Tang Pin	S&F	Size 16	13A	14-16AWG	-	3.2mm	Tin-Plated	Reel (3000 PCS)
SP14M2N	2 Tang Pin	S&F	Size 16	13A	14-16AWG	-	3.2mm	Nickel-Plated	Reel (3000 PCS)
SP14M2F	3 Tang Pin	S&F	Size 16	13A	14-16AWG	-	3.2mm	Gold 1µ" Flash	Reel (3000 PCS)
SP14M2G5	3 Tang Pin	S&F	Size 16	13A	14-16AWG	-	3.2mm	Gold 5µ" Flash	Reel (3000 PCS)
SP14M2G10	3 Tang Pin	S&F	Size 16	13A	14-16AWG	-	3.2mm	Gold 10µ" Flash	Reel (3000 PCS)
SP14M2G15	3 Tang Pin	S&F	Size 16	13A	14-16AWG	-	3.2mm	Gold 15µ" Flash	Reel (3000 PCS)
SP14M2G30	3 Tang Pin	S&F	Size 16	13A	14-16AWG	-	3.2mm	Gold 30µ" Flash	Reel (3000 PCS)
SP16M2T	3 Tang Pin	S&F	Size 16	13A	16-18AWG	-	3.2mm	Tin-Plated	Reel (3000 PCS)
SP16M2N	3 Tang Pin	S&F	Size 16	13A	16-18AWG	-	3.2mm	Nickel-Plated	Reel (3000 PCS)
SP16M2F	3 Tang Pin	S&F	Size 16	13A	16-18AWG	-	3.2mm	Gold Flash	Reel (3000 PCS)
SP16M2G5	3 Tang Pin	S&F	Size 16	13A	16-18AWG	-	3.2mm	Gold 5µ" Flash	Reel (3000 PCS)
SP16M2G10	3 Tang Pin	S&F	Size 16	13A	16-18AWG	-	3.2mm	Gold 10µ" Flash	Reel (3000 PCS)
SP16M2G15	3 Tang Pin	S&F	Size 16	13A	16-18AWG	-	3.2mm	Gold 15µ" Flash	Reel (3000 PCS)
SP16M2G30	3 Tang Pin	S&F	Size 16	13A	16-18AWG	-	3.2mm	Gold 30µ" Flash	Reel (3000 PCS)
SP20M2T	3 Tang Pin	S&F	Size 16	13A	20-22AWG	-	2.5mm	Tin-Plated	Reel (3000 PCS)
SP20M2F	3 Tang Pin	S&F	Size 16	13A	20-22AWG	-	2.5mm	Gold 1µ" Flash	Reel (3000 PCS)
SP20M2G5	3 Tang Pin	S&F	Size 16	13A	20-22AWG	-	2.5mm	Gold 5µ" Flash	Reel (3000 PCS)
SP20M2G10	3 Tang Pin	S&F	Size 16	13A	20-22AWG	-	2.5mm	Gold 10µ" Flash	Reel (3000 PCS)
SP20M2G15	3 Tang Pin	S&F	Size 16	13A	20-22AWG	-	2.5mm	Gold 15µ" Flash	Reel (3000 PCS)
SP20M2G30	3 Tang Pin	S&F	Size 16	13A	20-22AWG	-	2.5mm	Gold 30µ" Flash	Reel (3000 PCS)
AT60-20-0122	Pin	S&F	Size 20	7.5A	16-22AWG	1.5-0.35mm <sup>2</sup>	1.91 - 3.15mm	Nickel-Plated	Reel (4000 PCS)
AT60-20-0122-LP	Pin	S&F	Size 20	7.5A	16-22AWG	1.5-0.35mm <sup>2</sup>	1.91 - 3.15mm	Nickel-Plated	Bag (50 PCS)
AT60-20-0144	Pin	S&F	Size 20	7.5A	16-22AWG	1.5-0.35mm <sup>2</sup>	1.91 - 3.15mm	Gold-Plated	Reel (4000 PCS)
AT60-20-0144-LP	Pin	S&F	Size 20	7.5A	16-22AWG	1.5-0.35mm <sup>2</sup>	1.91 - 3.15mm	Gold-Plated	Bag (50 PCS)
AT60-20-0222	Pin	S&F	Size 20	7.5A	16-22AWG	1.5-0.35mm <sup>2</sup>	1.30 - 2.16mm	Nickel-Plated	Reel (4000 PCS)
AT60-20-0244	Pin	S&F	Size 20	7.5A	16-22AWG	1.5-0.35mm <sup>2</sup>	1.30 - 2.16mm	Gold-Plated	Reel (4000 PCS)
AT60-20-0277	Pin	S&F	Size 20	7.5A	16-22AWG	1.5-0.35mm <sup>2</sup>	1.30 - 2.16mm	Tin-Plated	Reel (4000 PCS)
AT60-20-0422	Pin	S&F	Size 20	7.5A	20-22AWG	0.5-0.35mm <sup>2</sup>	1.25 - 1.8mm	Nickel-Plated	Reel (4000 PCS)
AT60-20-0444	Pin	S&F	Size 20	7.5A	20-22AWG	0.5-0.35mm <sup>2</sup>	1.25 - 1.8mm	Gold-Plated	Reel (4000 PCS)
SP20W2T	3 Tang Pin	S&F	Size 20	5A	18-22AWG	-	2.6mm	Tin-Plated	Reel (3000 PCS)
SP20W2N	3 Tang Pin	S&F	Size 20	5A	18-22AWG	-	2.6mm	Nickel-Plated	Reel (3000 PCS)
SP20W2F	3 Tang Pin	S&F	Size 20	5A	18-22AWG	-	2.6mm	Gold Flash	Reel (3000 PCS)
SP20W2G5	3 Tang Pin	S&F	Size 20	5A	18-22AWG	-	2.6mm	Gold 5µ" Flash	Reel (3000 PCS)
SP20W2G10	3 Tang Pin	S&F	Size 20	5A	18-22AWG	-	2.6mm	Gold 10µ" Flash	Reel (3000 PCS)
SP20W2G15	3 Tang Pin	S&F	Size 20	5A	18-22AWG	-	2.6mm	Gold 15µ" Flash	Reel (3000 PCS)
SP20W2G30	3 Tang Pin	S&F	Size 20	5A	18-22AWG	-	2.6mm	Gold 30µ" Flash	Reel (3000 PCS)
SP24W2T	3 Tang Pin	S&F	Size 20	5A	24-26AWG	-	2.2mm	Tin-Plated	Reel (3000 PCS)
SP24W2N	3 Tang Pin	S&F	Size 20	5A	24-26AWG	-	2.2mm	Nickel-Plated	Reel (3000 PCS)
SP24W2F	3 Tang Pin	S&F	Size 20	5A	24-26AWG	-	2.2mm	Gold Flash	Reel (3000 PCS)
SP24W2G5	3 Tang Pin	S&F	Size 20	5A	24-26AWG	-	2.2mm	Gold 5µ" Flash	Reel (3000 PCS)

Part Number	Type	Style	Contact Size	Amp	Wire Range AWG	Wire Range mm <sup>2</sup>	Insulation OD mm	Plating	Packaging
SP24W2G10	3 Tang Pin	S&F	Size 20	5A	24-26AWG	-	2.2mm	Gold 10µ" Flash	Reel (3000 PCS)
SP24W2G15	3 Tang Pin	S&F	Size 20	5A	24-26AWG	-	2.2mm	Gold 15µ" Flash	Reel (3000 PCS)
SP24W2G30	3 Tang Pin	S&F	Size 20	5A	24-26AWG	-	2.2mm	Gold 30µ" Flash	Reel (3000 PCS)
SP28W2T	3 Tang Pin	S&F	Size 20	5A	28-30AWG	-	1.8mm	Tin-Plated	Reel (3000 PCS)
SP28W2N	3 Tang Pin	S&F	Size 20	5A	28-30AWG	-	1.8mm	Nickel-Plated	Reel (3000 PCS)
SP28W2F	3 Tang Pin	S&F	Size 20	5A	28-30AWG	-	1.8mm	Gold Flash	Reel (3000 PCS)
SP28W2G5	3 Tang Pin	S&F	Size 20	5A	28-30AWG	-	1.8mm	Gold 5µ" Flash	Reel (3000 PCS)
SP28W2G10	3 Tang Pin	S&F	Size 20	5A	28-30AWG	-	1.8mm	Gold 10µ" Flash	Reel (3000 PCS)
SP28W2G15	3 Tang Pin	S&F	Size 20	5A	28-30AWG	-	1.8mm	Gold 15µ" Flash	Reel (3000 PCS)
SP28W2G30	3 Tang Pin	S&F	Size 20	5A	28-30AWG	-	1.8mm	Gold 30µ" Flash	Reel (3000 PCS)
SC000571T	Pin	S&F	Size 1.0mm x 0.64mm	5A	20-22AWG	-	1.8mm	Tin-Plated	Reel (4000 PCS)
SC000571N	Pin	S&F	Size 1.0mm x 0.64mm	5A	20-22AWG	-	1.8mm	Nickel-Plated	Reel (4000 PCS)
SC000571F	Pin	S&F	Size 1.0mm x 0.64mm	5A	20-22AWG	-	1.8mm	Gold 1µ" Flash	Reel (4000 PCS)
SC000571G5	Pin	S&F	Size 1.0mm x 0.64mm	5A	20-22AWG	-	1.8mm	Gold 5µ" Flash	Reel (4000 PCS)
SC000571G10	Pin	S&F	Size 1.0mm x 0.64mm	5A	20-22AWG	-	1.8mm	Gold 10µ" Flash	Reel (4000 PCS)
SC000571G15	Pin	S&F	Size 1.0mm x 0.64mm	5A	20-22AWG	-	1.8mm	Gold 15µ" Flash	Reel (4000 PCS)
SC000571G30	Pin	S&F	Size 1.0mm x 0.64mm	5A	20-22AWG	-	1.8mm	Gold 30µ" Flash	Reel (4000 PCS)
AT62-12-0222	Socket	S&F	Size 12	25A	10-12AWG	6.0-4.0mm <sup>2</sup>	3.56 - 5.18mm	Nickel-Plated	Reel (2000 PCS)
AT62-12-0222-LP	Socket	S&F	Size 12	25A	10-12AWG	6.0-4.0mm <sup>2</sup>	3.56 - 5.18mm	Nickel-Plated	Bag (50 PCS)
AT62-12-0244	Socket	S&F	Size 12	25A	10-12AWG	6.0-4.0mm <sup>2</sup>	3.56 - 5.18mm	Gold-Plated	Reel (2000 PCS)
AT62-12-0244-LP	Socket	S&F	Size 12	25A	10-12AWG	6.0-4.0mm <sup>2</sup>	3.56 - 5.18mm	Gold-Plated	Bag (50 PCS)
AT62-12-0144	Socket	S&F	Size 12	25A	12-14AWG	4.0-2.0mm <sup>2</sup>	2.87 - 4.47mm	Gold-Plated	Reel (2000 PCS)
AT62-12-0144-LP	Socket	S&F	Size 12	25A	12-14AWG	4.0-2.0mm <sup>2</sup>	2.87 - 4.47mm	Gold-Plated	Bag (50 PCS)
AT62-12-0166	Socket	S&F	Size 12	25A	12-14AWG	4.0-2.0mm <sup>2</sup>	2.87 - 4.47mm	Nickel-Plated	Reel (2000 PCS)
AT62-12-0166-LP	Socket	S&F	Size 12	25A	12-14AWG	4.0-2.0mm <sup>2</sup>	2.87 - 4.47mm	Nickel-Plated	Bag (50 PCS)
SS12A1T	Socket	S&F	Size 2.5mm	23A	12-14AWG	-	4.3mm Insul OD	Tin-Plated	Reel (1000 PCS)
SS12A1F-10	Socket	S&F	Size 2.5mm	23A	12-14AWG	-	4.3mm Insul OD	Tin-Plated	Reel (1000 PCS)
SS12A1F	Socket	S&F	Size 2.5mm	23A	12-14AWG	-	4.3mm Insul OD	Gold-Flash	Reel (1000 PCS)
SS12A1F-10	Socket	S&F	Size 2.5mm	23A	12-14AWG	-	4.3mm Insul OD	Gold-Flash	Reel (1000 PCS)
SS12A1G10	Socket	S&F	Size 2.5mm	23A	12-14AWG	-	4.3mm Insul OD	Gold 10µ" Flash	Reel (1000 PCS)
SS12A1G10-10	Socket	S&F	Size 2.5mm	23A	12-14AWG	-	4.3mm Insul OD	Gold 10µ" Flash	Reel (1000 PCS)
SS12A1G15	Socket	S&F	Size 2.5mm	23A	12-14AWG	-	4.3mm Insul OD	Gold 15µ" Flash	Reel (1000 PCS)
SS12A1G15-10	Socket	S&F	Size 2.5mm	23A	12-14AWG	-	4.3mm Insul OD	Gold 15µ" Flash	Reel (1000 PCS)
SS12A1G30	Socket	S&F	Size 2.5mm	23A	12-14AWG	-	4.3mm Insul OD	Gold 30µ" Flash	Reel (1000 PCS)
SS12A1G30-10	Socket	S&F	Size 2.5mm	23A	12-14AWG	-	4.3mm Insul OD	Gold 30µ" Flash	Reel (1000 PCS)
AT62-14-0122	Socket	S&F	Size 16	13A	14-18AWG	2.0-0.75mm <sup>2</sup>	2.40 - 3.81mm	Nickel-Plated	Reel (4000 PCS)
AT62-14-0122-LP	Socket	S&F	Size 16	13A	14-18AWG	2.0-0.75mm <sup>2</sup>	2.40 - 3.81mm	Nickel-Plated	Bag (50 PCS)
AT62-14-0144	Socket	S&F	Size 16	13A	14-18AWG	2.0-0.75mm <sup>2</sup>	2.40 - 3.81mm	Gold-Plated	Reel (4000 PCS)
AT62-14-0144-LP	Socket	S&F	Size 16	13A	14-18AWG	2.0-0.75mm <sup>2</sup>	2.40 - 3.81mm	Gold-Plated	Bag (50 PCS)
AT62-16-0122	Socket	S&F	Size 16	13A	16-18AWG	1.5-0.75mm <sup>2</sup>	1.91 - 3.55mm	Nickel-Plated	Reel (4000 PCS)
AT62-16-0122-LP	Socket	S&F	Size 16	13A	16-18AWG	1.5-0.75mm <sup>2</sup>	1.91 - 3.55mm	Nickel-Plated	Bag (50 PCS)
AT62-16-0144	Socket	S&F	Size 16	13A	16-18AWG	1.5-0.75mm <sup>2</sup>	1.91 - 3.55mm	Gold-Plated	Reel (4000 PCS)
AT62-16-0144-LP	Socket	S&F	Size 16	13A	16-18AWG	1.5-0.75mm <sup>2</sup>	1.91 - 3.55mm	Gold-Plated	Bag (50 PCS)
AT62-16-0622	Socket	S&F	Size 16	13A	16-20AWG	1.0-0.5mm <sup>2</sup>	1.40 - 2.54mm	Nickel-Plated	Reel (4000 PCS)
AT62-16-0622-LP	Socket	S&F	Size 16	13A	16-20AWG	1.0-0.5mm <sup>2</sup>	1.40 - 2.54mm	Nickel-Plated	Bag (50 PCS)
AT62-16-0644	Socket	S&F	Size 16	13A	18-20AWG	1.0-0.5mm <sup>2</sup>	1.40 - 2.54mm	Gold-Plated	Reel (4000 PCS)
AT62-16-0644-LP	Socket	S&F	Size 16	13A	18-20AWG	1.0-0.5mm <sup>2</sup>	1.40 - 2.54mm	Gold-Plated	Bag (50 PCS)
AT62-16-0822	Socket	S&F	Size 16	13A	20-22AWG	0.5-0.35mm <sup>2</sup>	1.31 - 1.50mm	Nickel-Plated	Reel (4000 PCS)
AT62-16-0844	Socket	S&F	Size 16	13A	20-22AWG	0.5-0.35mm <sup>2</sup>	1.31 - 1.50mm	Gold-Plated	Reel (4000 PCS)
SS14M2T	3 Tang Socket	S&F	Size 16	13A	14-16AWG	-	3.2mm Insul OD	Tin-Plated	Reel (3000 PCS)
SS14M2N	3 Tang Socket	S&F	Size 16	13A	14-16AWG	-	3.2mm Insul OD	Nickel-Plated	Reel (3000 PCS)
SS14M2F	3 Tang Socket	S&F	Size 16	13A	14-16AWG	-	3.2mm Insul OD	Gold Flash	Reel (3000 PCS)

Part Number	Type	Style	Contact Size	Amp	Wire Range AWG	Wire Range mm <sup>2</sup>	Insulation OD mm	Plating	Packaging
SS14M2G5	3 Tang Socket	S&F	Size 16	13A	14-16AWG	-	3.2mm Insul OD	Gold 5µ" Flash	Reel (3000 PCS)
SS14M2G10	3 Tang Socket	S&F	Size 16	13A	14-16AWG	-	3.2mm Insul OD	Gold 10µ" Flash	Reel (3000 PCS)
SS14M2G15	3 Tang Socket	S&F	Size 16	13A	14-16AWG	-	3.2mm Insul OD	Gold 15µ" Flash	Reel (3000 PCS)
SS14M2G30	3 Tang Socket	S&F	Size 16	13A	14-16AWG	-	3.2mm Insul OD	Gold 30µ" Flash	Reel (3000 PCS)
SS16M2T	3 Tang Socket	S&F	Size 16	13A	16-18AWG	-	3.2mm Insul OD	Gold 30µ" Flash	Reel (3000 PCS)
SS16M2N	3 Tang Socket	S&F	Size 16	13A	16-18AWG	-	3.2mm Insul OD	Nickel-Plated	Reel (3000 PCS)
SS16M2F	3 Tang Socket	S&F	Size 16	13A	16-18AWG	-	3.2mm Insul OD	Gold 1µ" Flash	Reel (3000 PCS)
SS16M2G5	3 Tang Socket	S&F	Size 16	13A	16-18AWG	-	3.2mm Insul OD	Gold 5µ" Flash	Reel (3000 PCS)
SS16M2G10	3 Tang Socket	S&F	Size 16	13A	16-18AWG	-	3.2mm Insul OD	Gold 10µ" Flash	Reel (3000 PCS)
SS16M2G15	3 Tang Socket	S&F	Size 16	13A	16-18AWG	-	3.2mm Insul OD	Gold 15µ" Flash	Reel (3000 PCS)
SS16M2G30	3 Tang Socket	S&F	Size 16	13A	16-18AWG	-	3.2mm Insul OD	Gold 30µ" Flash	Reel (3000 PCS)
SS20M2T	3 Tang Socket	S&F	Size 16	13A	20-22AWG	-	2.5mm Insul OD	Tin-Plated	Reel (3000 PCS)
SS20M2N	3 Tang Socket	S&F	Size 16	13A	20-22AWG	-	2.5mm Insul OD	Nickel-Plated	Reel (3000 PCS)
SS20M2F	3 Tang Socket	S&F	Size 16	13A	20-22AWG	-	2.5mm Insul OD	Gold 1µ" Flash	Reel (3000 PCS)
SS20M2G5	3 Tang Socket	S&F	Size 16	13A	20-22AWG	-	2.5mm Insul OD	Gold 5µ" Flash	Reel (3000 PCS)
SS20M2G10	3 Tang Socket	S&F	Size 16	13A	20-22AWG	-	2.5mm Insul OD	Gold 10µ" Flash	Reel (3000 PCS)
SS20M2G15	3 Tang Socket	S&F	Size 16	13A	20-22AWG	-	2.5mm Insul OD	Gold 15µ" Flash	Reel (3000 PCS)
SS20M2G30	3 Tang Socket	S&F	Size 16	13A	20-22AWG	-	2.5mm Insul OD	Gold 30µ" Flash	Reel (3000 PCS)
AT62-20-0122	Socket	S&F	Size 20	7.5A	16-22AWG	1.5-0.35mm <sup>2</sup>	1.91 - 3.15mm	Nickel-Plated	Reel (4000 PCS)
AT62-20-0122-LP	Socket	S&F	Size 20	7.5A	16-22AWG	1.5-0.35mm <sup>2</sup>	1.91 - 3.15mm	Nickel-Plated	Bag (50 PCS)
AT62-20-0144	Socket	S&F	Size 20	7.5A	16-22AWG	1.5-0.35mm <sup>2</sup>	1.91 - 3.15mm	Gold-Plated	Reel (4000 PCS)
AT62-20-0144-LP	Socket	S&F	Size 20	7.5A	16-22AWG	1.5-0.35mm <sup>2</sup>	1.91 - 3.15mm	Gold-Plated	Bag (50 PCS)
AT62-20-0222	Socket	S&F	Size 20	7.5A	16-22AWG	1.5-0.35mm <sup>2</sup>	1.30 - 2.16mm	Nickel-Plated	Reel (4000 PCS)
AT62-20-0244	Socket	S&F	Size 20	7.5A	16-22AWG	1.5-0.35mm <sup>2</sup>	1.30 - 2.16mm	Gold-Plated	Reel (4000 PCS)
AT62-20-0277	Socket	S&F	Size 20	7.5A	16-22AWG	1.5-0.35mm <sup>2</sup>	1.30 - 2.16mm	Tin-Plated	Reel (4000 PCS)
AT62-20-0422	Socket	S&F	Size 20	7.5A	20-22AWG	0.5-0.35mm <sup>2</sup>	1.25 - 1.8mm	Nickel-Plated	Reel (4000 PCS)
AT62-20-0444	Socket	S&F	Size 20	7.5A	20-22AWG	0.5-0.35mm <sup>2</sup>	1.25 - 1.8mm	Gold-Plated	Reel (4000 PCS)
SS20W2T	3 Tang Socket	S&F	Size 20	5A	18-22AWG	-	2.6mm	Tin-Plated	Reel (3000 PCS)
SS20W2N	3 Tang Socket	S&F	Size 20	5A	18-22AWG	-	2.6mm	Nickel-Plated	Reel (3000 PCS)
SS20W2F	3 Tang Socket	S&F	Size 20	5A	18-22AWG	-	2.6mm	Gold Flash	Reel (3000 PCS)
SS20W2G5	3 Tang Socket	S&F	Size 20	5A	18-22AWG	-	2.6mm	Gold 5µ"	Reel (3000 PCS)
SS20W2G10	3 Tang Socket	S&F	Size 20	5A	18-22AWG	-	2.6mm	Gold 10µ"	Reel (3000 PCS)
SS20W2G15	3 Tang Socket	S&F	Size 20	5A	18-22AWG	-	2.6mm	Gold 15µ"	Reel (3000 PCS)
SS20W2G30	3 Tang Socket	S&F	Size 20	5A	18-22AWG	-	2.6mm	Gold 30µ"	Reel (3000 PCS)
SS24W2T	3 Tang Socket	S&F	Size 20	5A	24-26AWG	-	2.2mm	Tin-Plated	Reel (3000 PCS)
SS24W2N	3 Tang Socket	S&F	Size 20	5A	24-26AWG	-	2.2mm	Nickel-Plated	Reel (3000 PCS)
SS24W2F	3 Tang Socket	S&F	Size 20	5A	24-26AWG	-	2.2mm	Gold Flash	Reel (3000 PCS)
SS24W2G5	3 Tang Socket	S&F	Size 20	5A	24-26AWG	-	2.2mm	Gold 5µ"	Reel (3000 PCS)
SS24W2G10	3 Tang Socket	S&F	Size 20	5A	24-26AWG	-	2.2mm	Gold 10µ"	Reel (3000 PCS)
SS24W2G15	3 Tang Socket	S&F	Size 20	5A	24-26AWG	-	2.2mm	Gold 15µ"	Reel (3000 PCS)
SS24W2G30	3 Tang Socket	S&F	Size 20	5A	24-26AWG	-	2.2mm	Gold 30µ"	Reel (3000 PCS)
SS28W2T	3 Tang Socket	S&F	Size 20	5A	28-30AWG	-	1.8mm	Tin-Plated	Reel (3000 PCS)
SS28W2N	3 Tang Socket	S&F	Size 20	5A	28-30AWG	-	1.8mm	Nickel-Plated	Reel (3000 PCS)
SS28W2F	3 Tang Socket	S&F	Size 20	5A	28-30AWG	-	1.8mm	Gold Flash	Reel (3000 PCS)
SS28W2G5	3 Tang Socket	S&F	Size 20	5A	28-30AWG	-	1.8mm	Gold 5µ"	Reel (3000 PCS)
SS28W2G10	3 Tang Socket	S&F	Size 20	5A	28-30AWG	-	1.8mm	Gold 10µ"	Reel (3000 PCS)
SS28W2G15	3 Tang Socket	S&F	Size 20	5A	28-30AWG	-	1.8mm	Gold 15µ"	Reel (3000 PCS)
SS28W2G30	3 Tang Socket	S&F	Size 20	5A	28-30AWG	-	1.8mm	Gold 30µ"	Reel (3000 PCS)
SC000572T	Socket	S&F	Size 1.0mm x 0.64mm	5A	20-22AWG	-	1.8mm Insul OD	Tin-Plated	Reel (4000 PCS)
SC000572N	Socket	S&F	Size 1.0mm x 0.64mm	5A	20-22AWG	-	1.8mm Insul OD	Nickel-Plated	Reel (4000 PCS)
SC000572F	Socket	S&F	Size 1.0mm x 0.64mm	5A	20-22AWG	-	1.8mm Insul OD	Gold 1µ" Flash	Reel (4000 PCS)
SC000572G5	Socket	S&F	Size 1.0mm x 0.64mm	5A	20-22AWG	-	1.8mm Insul OD	Gold 5µ" Flash	Reel (4000 PCS)
SC000572G10	Socket	S&F	Size 1.0mm x 0.64mm	5A	20-22AWG	-	1.8mm Insul OD	Gold 10µ" Flash	Reel (4000 PCS)

Part Number	Type	Style	Contact Size	Amp	Wire Range AWG	Wire Range mm <sup>2</sup>	Insulation OD mm	Plating	Packaging
SC000572G15	Socket	S&F	Size 1.0mm x 0.64mm	5A	20-22AWG	-	1.8mm Insul OD	Gold 15µ" Flash	Reel (4000 PCS)
SC000572G30	Socket	S&F	Size 1.0mm x 0.64mm	5A	20-22AWG	-	1.8mm Insul OD	Gold 30µ" Flash	Reel (4000 PCS)

A Series™ Contacts - Tooling

Part Number	Tool Name	Style	Contact Size	Wire Range	Material	Color
QXRT08	Contact Extraction Tool	Machined	Size 3.6mm	-	Aluminum Alloy	Black
QXRT08-ATPH3	Contact Extraction Tool, ATPH Series™ Only	Machined	Size 10 (3.0mm)	-	Aluminum Alloy	Black
AT11-027-0405	Contact Extraction Tool	Machined	Size 4	4AWG	Plastic	Black
AT114008	Contact Extraction Tool	Machined	Size 8	8-10AWG	Plastic	Green
QXATHP-50	Contact Extraction Tool	Machined	Size 8mm	-	-	-
MF3-3966	Contact Locator for Hand Crimp Tool M300-25A	Machined	Size 12	10AWG	-	-
96-978-22	Crimper and Die	Machined	Size 3.6mm-10mm	10mm <sup>2</sup> -185mm <sup>2</sup>	-	-
M300BT	Hand Crimp Tool	Machined	-	6-14AWG	-	-
AUTK-12	Hand Crimp Tool	Machined	Size 12	10-18AWG	-	-
AUTK-16	Hand Crimp Tool	Machined	Size 16	-	-	-
AUTK-20	Hand Crimp Tool	Machined	Size 20	12-26AWG	-	-
MF3-3959	Hand Crimp Tool	Machined	Size 20	12-26AWG	-	-
M300-25A	Hand Crimp Tool w MF3-3966 Locator	Machined	Size 12	10-18AWG	-	-
FT-ATS26P	ATS Series™ Installation Fixture for ATS04-26P	Machined	-	-	Resin	White
WA23	Pneumatic Crimp Tool	Machined	-	8-0000AWG	-	-
CA-5E12	Pneumatic Crimp Tool	Machined	Size 12/16/20	12-26AWG	-	-
MF3-3960	Pneumatic Crimp Tool	Machined	Size 12/16/20	12-26AWG	-	-
WA27-300BT-EP	Pneumatic Crimp Tool for M300BT	Machined	-	-	-	-
TP968	Single Position Head for M300BT Hand Crimp Tool	Machined	Size 8/10/12/14	-	-	-
CA-5D12	Universal Hand Crimp Tool	Machined	Size 12/16/20	12-26AWG	-	-
AUTK-100	Universal Heavy Duty Contact Crimping Tool Kit	Machined	Size 12/16/20	12-26AWG	-	-
WA23-138DA	WA23 Die Assembly for Pneumatic Crimp Tool	Machined	Size 4	4AWG	-	Silver
WA23-184DA	WA23 Die Assembly for Pneumatic Crimp Tool	Machined	Size 2	2AWG	-	-
WA23-2	WA23 Die Assembly for Pneumatic Crimp Tool	Machined	Size 8	8AWG	-	Silver
WA23-3	WA23 Die Assembly for Pneumatic Crimp Tool	Machined	Size 6	6AWG	-	-
WA23-8	WA23 Die Assembly for Pneumatic Crimp Tool	Machined	Size 1	1AWG	-	-
WA23-10	WA23 Locator for Pneumatic Crimp Tool	Machined	Size 6	6AWG	-	Blue
WA23-11	WA23 Locator for Pneumatic Crimp Tool	Machined	Size 4	4AWG	-	Blue
QXRT16	Contact Extraction Tool (Size 16 Contacts Only)	S&F	Size 16	-	Aluminum Alloy	Black
MF3-3990	Crimp Die	S&F	Size 16	20-22AWG	-	-
MF3-3957	Crimp Die Press Applicator	S&F	Size 16/20	16-20AWG	-	-
MF3-4017-G or K	Crimp Die Press Applicator	S&F	Size 1.0 x 0.64mm	20-22AWG	-	-
MF3-4018-G or K	Crimp Die Press Applicator	S&F	Size 1.0 x 0.64mm	20-22AWG	-	-
MF3-3973-G or K	Crimp Die Press Applicator	S&F	Size 12	12AWG	-	-
MF3-3985-G or K	Crimp Die Press Applicator	S&F	Size 12	10-12AWG	-	-
MF3-3950-G or K	Crimp Die Press Applicator	S&F	Size 16	18-20AWG	-	-
MF3-3953-G or K	Crimp Die Press Applicator	S&F	Size 16	16-18AWG	-	-
MF3-3975-G or K	Crimp Die Press Applicator	S&F	Size 16	14-16AWG	-	-
MF3-3964-G or K	Crimp Die Press Applicator	S&F	Size 16/20	16-20AWG	-	-
MF3-3974-G or K	Crimp Die Press Applicator	S&F	Size 20	20AWG	-	-
MF3-3976-G or K	Crimp Die Press Applicator	S&F	Size 20	20-22AWG	-	-
MF3-3978-G or K	Crimp Die Press Applicator	S&F	Size 20	20-22AWG	-	-
ATT-8M-01	Contact Crimp Tool	S&F	Size 8	6mm <sup>2</sup> /10mm <sup>2</sup>	-	-
ATT-8M-02	Contact Crimp Tool	S&F	Size 8	16mm <sup>2</sup> Wire	-	-
ATT-12-00	Contact Crimp Tool	S&F	Size 12	12-14AWG	-	-
ATT-12-01	Contact Crimp Tool	S&F	Size 12	10AWG/6mm <sup>2</sup> /12AWG	-	-

Part Number	Tool Name	Style	Contact Size	Wire Range	Material	Color
ATT-16-00	Contact Crimp Tool	S&F	Size 16	14AWG/16AWG/18AWG	-	-
ATT-16-01	Contact Crimp Tool	S&F	Size 16	16AWG/18AWG/20AWG	-	-
ATT-1612-03	Contact Crimp Tool	S&F	Size 12/16	14AWG/20AWG/22AWG	-	-
ATT-20-00	Contact Crimp Tool	S&F	Size 20	16AWG/18AWG/20AWG	-	-
MFX-3954	Contact Crimp Tool	S&F	Size 16	14-20AWG	-	-
MFX-3962	Contact Crimp Tool	S&F	Size 2.5mm	-	-	-
MFX-3958	Contact Crimp Tool	S&F	Size 20	20-28AWG	-	-

ATRT-100	Contact and Wedglock Extraction Tool	Universal	-	-	Steel	Silver
AT11-337-1205	Contact Extraction Tool	Universal	Size 12	-	Plastic	Orange
AT11-310-1605	Contact Extraction Tool	Universal	Size 16	-	Plastic	Lt Blue
AT11-240-2005	Contact Extraction Tool	Universal	Size 20	-	Plastic	Red
QXRT20-ATS26P	ATS Series™ Contact Extraction Tool	Universal	Size 20	-	Aluminum Alloy	Black
ISRT20	Contact Insertion Tool	Universal	Size 20	-	Plastic	Red
AT13-215-1605	Keying Pin	Universal	Size 16	-	Thermoplastic	White
AT13-216-2005	Keying Pin	Universal	Size 20	-	Thermoplastic	Red
AT13-217-1605	Locking Seal Plug	Universal	Size 16	-	Thermoplastic	Grey
AT13-217-1605-SR	Locking Seal Plug	Universal	Size 16	-	Thermoplastic	Red
ATM13-217-2005	Locking Seal Plug	Universal	Size 20	-	Thermoplastic	Grey
ATM13-217-2005-SR	Locking Seal Plug	Universal	Size 20	-	Thermoplastic	Blue
A114017	Seal Plug	Universal	Size 12/16	-	Thermoplastic	White
A114017-SR	Seal Plug	Universal	Size 16	-	Thermoplastic	Black
CA-4020-59	Seal Plug	Universal	Size 16/20	-	Plastic	White
AT13-204-2005	Seal Plug	Universal	Size 20	-	Thermoplastic	White
AT13-204-2005-SR	Seal Plug	Universal	Size 20	-	Thermoplastic	Black
A114019	Seal Plug	Universal	Size 4	-	Thermoplastic	Red
A114018	Seal Plug	Universal	Size 8	-	Thermoplastic	White

A Series™ Contacts - Machined Crimp Specifications

Product Series	Position	Contact Size	Pin PN	Socket PN	Plating	Wire Range	Recommended Strip Length mm	Crimp Tensile Reference N	Max Rated Amperage
ATM Duramate AHDP	All 20, 21, 29, 33, 35, 47	Size 20	AT60-010-2031	AT62-005-2031	Gold-Plated	16-18AWG	3.96-5.54mm	89N	7.5A
			AT60-010-20141	AT62-005-20141	Nickel-Plated	16-18AWG	3.96-5.54mm	89N	7.5A
			AT60-202-2031	AT62-201-2031	Gold-Plated	20AWG	3.96-5.54mm	89N	7.5A
			AT60-202-20141	AT62-201-20141	Nickel-Plated	20AWG	3.96-5.54mm	89N	7.5A
AHD AT ATV Duramate AHDP/AHDM	9 All All 6, 7, 14, 18, 19, 20, 21, 23, 27, 29, 31, 35, 47	Size 16	AT60-215-1631	AT62-209-1631	Gold-Plated	14AWG	6.35-7.92mm	311N	13A
			AT60-215-16141	AT62-209-16141	Nickel-Plated	14AWG	6.35-7.92mm	311N	13A
			AT60-202-1631	AT62-201-1631	Gold-Plated	16-20AWG	6.35-7.92mm	156-89N	13A
			AT60-202-16141	AT62-201-16141	Nickel-Plated	16-20AWG	6.35-7.92mm	156-89N	13A
			AT60-202-1631-20	AT62-201-1631-20	Gold-Plated	18-20AWG	6.35-7.92mm	89N	13A
			AT60-202-16141-22	AT62-201-16141-22	Nickel-Plated	22-24AWG	6.35-7.92mm	35-22N	13A
AHD ATP ATHD-12P/-12S Duramate AHDP/AHDM	6 All 1 7, 8, 9, 14, 16, 18, 19, 21, 27, 29	Size 12	AT60-204-12141-10	AT62-203-12141-10	Nickel-Plated	10-12AWG	5.64-7.21mm	400-334N	25A
			AT60-220-1231	AT62-220-1231	Gold-Plated	12-14AWG	5.64-7.21mm	334-311N	25A
			AT60-204-12141	AT62-203-12141	Nickel-Plated	12-14AWG	5.64-7.21mm	334-311N	25A
			AT60-220-1231-1618	AT62-210-1231-1618	Gold-Plated	16-18AWG	5.64-7.21mm	156-111N	25A
ATHD-8P/-8S Duramate AHDP/AHDM	1 9, 18	Size 8	AT60-204-08141	AT62-203-08141	Nickel-Plated	8-10AWG	10.92-12.5mm	556-400N	60A
			ATHD-4P/-4S Duramate AHDP/AHDM	1 6, 7, 9, 14	Size 4	AT60-204-0490	AT62-203-04141	Nickel-Plated	6AWG
Duramate AHDP/AHDM	7 (CL22) Only	Size 4	AT60-204-04141-4	AT62-203-04141-4		Nickel-Plated	4AWG	10.92-12.5mm	1334N
Duramate AHDP/AHDM	7 Only		Size 3.6mm	SC000345	SC000346	Silver Plated	7-10AWG	10.92-12.5mm	556-400N

A Series™ Contacts - Stamped & Formed Crimp Specifications

Contact Size	Pin PN	Socket PN	Insulation Dia Range mm (in)	Wire Size	Crimp Height mm (+/-0.12)	Crimp Width mm (+/-0.18)	Crimp Tensile Reference Lbs (N)
Size 12	AT60-12-01xx	AT62-12-01xx	2.87-4.47mm (0.113-0.176in)	4.0mm <sup>2</sup>	2.24mm	3.18mm	70Lbs (311N)
Size 12	AT60-12-01xx	AT62-12-01xx	2.87-4.47mm (0.113-0.176in)	12AWG	2.03mm	3.18mm	70Lbs (311N)
Size 12	AT60-12-01xx	AT62-12-01xx	2.87-4.47mm (0.113-0.176in)	3.0mm <sup>2</sup>	2.03mm	3.18mm	70Lbs (311N)
Size 12	AT60-12-01xx	AT62-12-01xx	2.87-4.47mm (0.113-0.176in)	2.5mm <sup>2</sup>	1.88mm	3.18mm	70Lbs (311N)
Size 12	AT60-12-01xx	AT62-12-01xx	2.87-4.47mm (0.113-0.176in)	14AWG	1.78mm	3.18mm	70Lbs (311N)
Size 12	AT60-12-01xx	AT62-12-01xx	2.87-4.47mm (0.113-0.176in)	2.0mm <sup>2</sup>	1.78mm	3.18mm	70Lbs (311N)
Size 12	AT60-12-02xx	AT62-12-02xx	3.56-5.18mm (0.140-0.204in)	6.0mm <sup>2</sup>	2.72mm	3.56mm	70Lbs (311N)
Size 12	AT60-12-02xx	AT62-12-02xx	3.56-5.18mm (0.140-0.204in)	10AWG	2.51mm	3.56mm	70Lbs (311N)
Size 12	AT60-12-02xx	AT62-12-02xx	3.56-5.18mm (0.140-0.204in)	5.0mm <sup>2</sup>	2.51mm	3.56mm	70Lbs (311N)
Size 12	AT60-12-02xx	AT62-12-02xx	3.56-5.18mm (0.140-0.204in)	4.0mm <sup>2</sup>	2.16mm	3.56mm	70Lbs (311N)
Size 16	AT60-14-01xx	AT62-14-01xx	2.41-3.81mm (0.095-0.150in)	14AWG	1.40mm	2.39mm	25Lbs (111N)
Size 16	AT60-14-01xx	AT62-14-01xx	2.41-3.81mm (0.095-0.150in)	2.0mm <sup>2</sup>	1.40mm	2.39mm	25Lbs (111N)
Size 16	AT60-14-01xx	AT62-14-01xx	2.41-3.81mm (0.095-0.150in)	1.5mm <sup>2</sup>	1.35mm	2.39mm	25Lbs (111N)
Size 16	AT60-14-01xx	AT62-14-01xx	2.41-3.81mm (0.095-0.150in)	16AWG	1.27mm	2.39mm	25Lbs (111N)
Size 16	AT60-14-01xx	AT62-14-01xx	2.41-3.81mm (0.095-0.150in)	1.0mm <sup>2</sup>	1.27mm	2.39mm	25Lbs (111N)
Size 16	AT60-14-01xx	AT62-14-01xx	2.41-3.81mm (0.095-0.150in)	18AWG	1.24mm	2.39mm	25Lbs (111N)
Size 16	AT60-14-01xx	AT62-14-01xx	2.41-3.81mm (0.095-0.150in)	0.75mm <sup>2</sup>	1.22mm	2.39mm	25Lbs (111N)
Size 16	AT60-16-01xx	AT62-16-01xx	1.90-3.5mm (0.075-0.140in)	14AWG	1.40mm	2.39mm	25Lbs (111N)
Size 16	AT60-16-01xx	AT62-16-01xx	1.90-3.5mm (0.075-0.140in)	2.0mm <sup>2</sup>	1.40mm	2.39mm	25Lbs (111N)
Size 16	AT60-16-01xx	AT62-16-01xx	1.90-3.5mm (0.075-0.140in)	1.5mm <sup>2</sup>	1.35mm	2.39mm	25Lbs (111N)
Size 16	AT60-16-01xx	AT62-16-01xx	1.90-3.5mm (0.075-0.140in)	16AWG	1.27mm	2.39mm	25Lbs (111N)
Size 16	AT60-16-01xx	AT62-16-01xx	1.90-3.5mm (0.075-0.140in)	1.0mm <sup>2</sup>	1.27mm	2.39mm	25Lbs (111N)
Size 16	AT60-16-01xx	AT62-16-01xx	1.90-3.5mm (0.075-0.140in)	18AWG	1.24mm	2.39mm	25Lbs (111N)
Size 16	AT60-16-01xx	AT62-16-01xx	1.90-3.5mm (0.075-0.140in)	0.75mm <sup>2</sup>	1.22mm	2.39mm	25Lbs (111N)
Size 16	AT60-16-06xx	AT62-16-06xx	1.40-2.54mm (0.055-0.100in)	16AWG	1.27mm	2.01mm	25Lbs (111N)
Size 16	AT60-16-06xx	AT62-16-06xx	1.40-2.54mm (0.055-0.100in)	1.0mm <sup>2</sup>	1.27mm	2.01mm	25Lbs (111N)
Size 16	AT60-16-06xx	AT62-16-06xx	1.40-2.54mm (0.055-0.100in)	18AWG	1.24mm	2.01mm	25Lbs (111N)
Size 16	AT60-16-06xx	AT62-16-06xx	1.40-2.54mm (0.055-0.100in)	0.75mm <sup>2</sup>	1.22mm	2.01mm	25Lbs (111N)
Size 16	AT60-16-06xx	AT62-16-06xx	1.40-2.54mm (0.055-0.100in)	20AWG	1.22mm	2.01mm	15Lbs (67N)
Size 16	AT60-16-06xx	AT62-16-06xx	1.40-2.54mm (0.055-0.100in)	0.50mm <sup>2</sup>	1.14mm	2.01mm	15Lbs (67N)

Contact Size	Pin PN	Socket PN	Insulation Dia Range mm (in)	Wire Size	Crimp Height mm (+/-0.12)	Crimp Width mm (+/-0.18)	Crimp Tensile Reference Lbs (N)
Size 16	AT60-16-08xx	AT62-16-08xx	1.20-2.10mm (0.047-0.083in)	20AWG	1.01mm	1.80mm	13Lbs (60N)
Size 16	AT60-16-08xx	AT62-16-08xx	1.20-2.10mm (0.047-0.083in)	0.50mm <sup>2</sup>	1.01mm	1.80mm	13Lbs (60N)
Size 16	AT60-16-08xx	AT62-16-08xx	1.20-2.10mm (0.047-0.083in)	22AWG	0.95mm	1.80mm	9Lbs (40N)
Size 16	AT60-16-08xx	AT62-16-08xx	1.20-2.10mm (0.047-0.083in)	0.35mm <sup>2</sup>	0.95mm	1.80mm	9Lbs (40N)
Size 20	AT60-20-01xx	AT62-20-01xx	1.91-3.15mm (0.075-0.125in)	1.5mm <sup>2</sup>	1.47mm	2.01mm	20Lbs (89N)
Size 20	AT60-20-01xx	AT62-20-01xx	1.91-3.15mm (0.075-0.125in)	16AWG	1.27mm	2.01mm	20Lbs (89N)
Size 20	AT60-20-01xx	AT62-20-01xx	1.91-3.15mm (0.075-0.125in)	1.0mm <sup>2</sup>	1.27mm	2.01mm	20Lbs (89N)
Size 20	AT60-20-01xx	AT62-20-01xx	1.91-3.15mm (0.075-0.125in)	18AWG	1.24mm	2.01mm	20Lbs (89N)
Size 20	AT60-20-01xx	AT62-20-01xx	1.91-3.15mm (0.075-0.125in)	0.75mm <sup>2</sup>	1.22mm	2.01mm	20Lbs (89N)
Size 20	AT60-20-01xx	AT62-20-01xx	1.91-3.15mm (0.075-0.125in)	0.60mm <sup>2</sup>	1.07mm	2.01mm	20Lbs (89N)
Size 20	AT60-20-01xx	AT62-20-01xx	1.91-3.15mm (0.075-0.125in)	20AWG	0.99mm	2.01mm	15Lbs (67N)
Size 20	AT60-20-01xx	AT62-20-01xx	1.91-3.15mm (0.075-0.125in)	0.50mm <sup>2</sup>	0.97mm	2.01mm	15Lbs (67N)
Size 20	AT60-20-01xx	AT62-20-01xx	1.91-3.15mm (0.075-0.125in)	22AWG	0.94mm	2.01mm	10Lbs (45N)
Size 20	AT60-20-01xx	AT62-20-01xx	1.91-3.15mm (0.075-0.125in)	0.35mm <sup>2</sup>	0.94mm	2.01mm	10Lbs (45N)
Size 20	AT60-20-02xx	AT62-20-02xx	1.30-2.16mm (0.051-0.085in)	1.5mm <sup>2</sup>	1.47mm	2.01mm	20Lbs (89N)
Size 20	AT60-20-02xx	AT62-20-02xx	1.30-2.16mm (0.051-0.085in)	16AWG	1.27mm	2.01mm	20Lbs (89N)
Size 20	AT60-20-02xx	AT62-20-02xx	1.30-2.16mm (0.051-0.085in)	1.0mm <sup>2</sup>	1.27mm	2.01mm	20Lbs (89N)
Size 20	AT60-20-02xx	AT62-20-02xx	1.30-2.16mm (0.051-0.085in)	18AWG	1.24mm	2.01mm	20Lbs (89N)
Size 20	AT60-20-02xx	AT62-20-02xx	1.30-2.16mm (0.051-0.085in)	0.75mm <sup>2</sup>	1.22mm	2.01mm	20Lbs (89N)
Size 20	AT60-20-02xx	AT62-20-02xx	1.30-2.16mm (0.051-0.085in)	0.60mm <sup>2</sup>	1.07mm	2.01mm	20Lbs (89N)
Size 20	AT60-20-02xx	AT62-20-02xx	1.30-2.16mm (0.051-0.085in)	20AWG	0.99mm	2.01mm	15Lbs (67N)
Size 20	AT60-20-02xx	AT62-20-02xx	1.30-2.16mm (0.051-0.085in)	0.50mm <sup>2</sup>	0.97mm	2.01mm	15Lbs (67N)
Size 20	AT60-20-02xx	AT62-20-02xx	1.30-2.16mm (0.051-0.085in)	22AWG	0.94mm	2.01mm	10Lbs (45N)
Size 20	AT60-20-02xx	AT62-20-02xx	1.30-2.16mm (0.051-0.085in)	0.35mm <sup>2</sup>	0.94mm	2.01mm	10Lbs (45N)

## Application Specification for Stamped & Formed Contacts

Precision engineered stamped & formed design provides cost effective wire processing, while ensuring high reliability conductor termination and performance

- Wire Size Range: 10AWG to 22AWG (6.0 - 0.35mm<sup>2</sup>)
- Available in Size 12, 14, 16 and 20 contacts, in both Pin and Socket
- Current Ratings up to 25A
- Copper Alloy, Nickel-Plated
- Gold plating options available

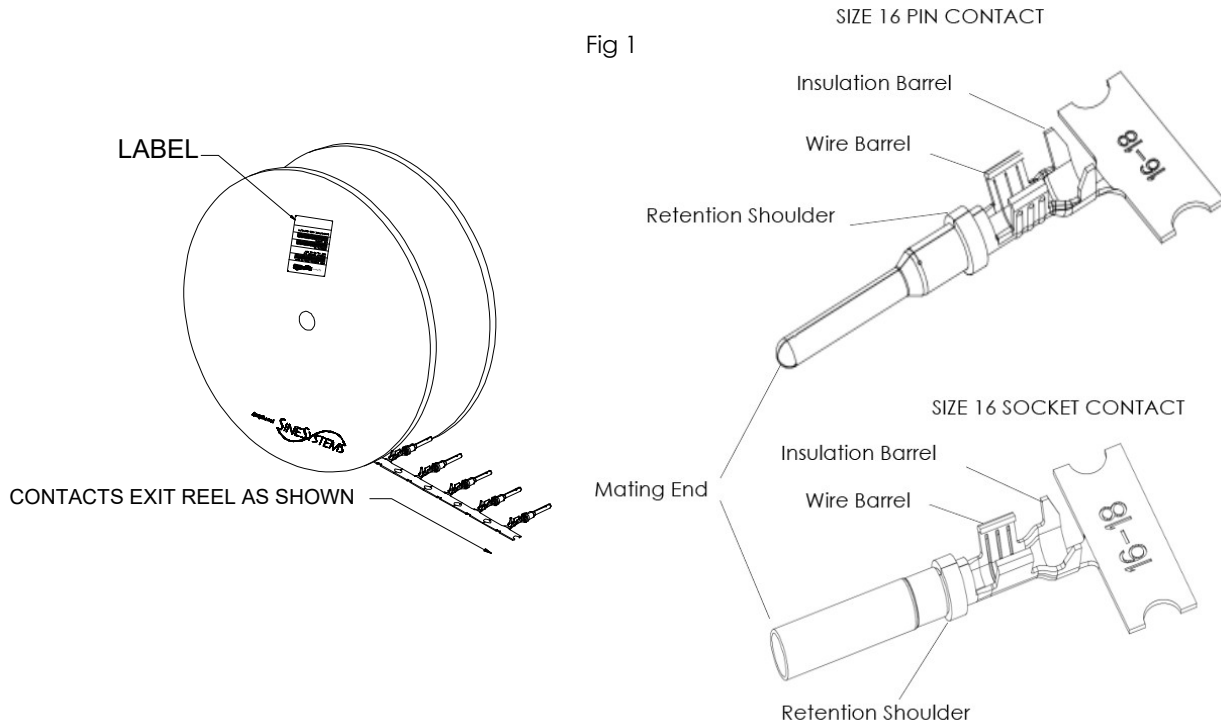

### 1. Introduction

This documentation covers requirements for use of Amphenol size 16 stamped and formed pin and socket contacts. These contacts are used in any Amphenol connectors having cavities that fit size 16 contacts. (See Fig 1) Each contact consists of a wire barrel, insulation barrel, retention shoulder, and mating end. The socket features a protective sleeve. The contacts are available strip-fed form for crimping using a hand tool or automatic machine.

### 2. Reference Material

#### 2.1. Customer Assistance

Part Numbers (listed below) are representative of Amphenol size 12, 16 and 20 stamped & formed pin and socket contacts. Use of these numbers will identify the product line and help you to obtain product and tooling information. This information is available on our website at [www.amphenol-sine.com](http://www.amphenol-sine.com)

**Pin:** AT60-12-01xx, AT60-12-02xx, AT60-14-01xx, AT60-16-01xx, AT60-16-06xx, AT60-16-08xx, AT60-20-01xx, AT60-20-02xx

**Socket:** AT62-12-01xx, AT62-12-02xx, AT62-14-01xx, AT62-16-01xx, AT62-16-06xx, AT62-16-08xx, AT62-20-01xx, AT62-20-02xx

#### 2.2. DRAWINGS

Customer drawings for product part numbers are available from [www.amphenol-sine.com](http://www.amphenol-sine.com). The information contained in the customer drawings takes priority.

### 3. Requirements

#### 3.1. Storage

##### A. Ultraviolet Light

Prolonged exposure to ultraviolet light may deteriorate the chemical composition used in the product material.

##### B. Shelf Life

The product should remain in the shipping containers until ready for use to prevent deformation to components. The product should be used on a first in, first out basis to avoid storage contamination that could adversely affect performance.

##### C. Reeled Contacts

When using reeled contacts, store coil wound reels horizontally and traverse wound reels vertically.

##### D. Chemical Exposure

Do not store product near any chemical listed below as they may cause stress corrosion cracking in the material.

- Alkalies Ammonia Citrates Phosphates Citrates Sulfur Compounds
- Amines Carbonates Nitrites Sulfur Nitrites Tartrates

#### 3.2. Operating Temperature

These contacts are designed to operate in a temperature range of -55 to 125°C [-67°F to 257°F].

#### 3.3. Material

The contacts are made of copper alloy. Plating material is provided on the contact-specific customer drawing.

#### 3.4. Wire Size And Preparation

The contacts accept stranded wire sizes and insulation diameters using wire standards in **Table 1**. For insulation diameter per contact, refer to the customer drawing for the contact. The wire must be stripped within the dimensions given in the table below. Special wire type which may require special applicator tooling settings, crimp requirements are not covered in this specification.

Table 1

Contact Size	Pin PN	Socket PN	Wire Size AWG (mm <sup>2</sup> )	Insulation Dia Range mm (in)	Recomm. Strip Length mm (in)
Size 12	AT60-12-01xx	AT62-12-01xx	12-14 AWG (4.0 - 2.0mm <sup>2</sup> )	2.87 - 4.47mm (0.113 - 0.176in)	5.72 - 7.00mm (0.225 - 0.275in)
	AT60-12-02xx	AT62-12-02xx	10AWG (6.0 - 4.0mm <sup>2</sup> )	3.56 - 5.18mm (0.140 - 0.204in)	5.72 - 7.00mm (0.225 - 0.275in)
Size 16	AT60-14-01xx	AT62-14-01xx	14 - 18AWG (2.0 - 0.75mm <sup>2</sup> )	2.41 - 3.81mm (0.095 - 0.150in)	3.81 - 5.08mm (0.150 - 0.200in)
	AT60-16-01xx	AT62-16-01xx	14 - 18AWG (2.0 - 0.75mm <sup>2</sup> )	1.90 - 3.55mm (0.075 - 0.140in)	3.81 - 5.08mm (0.150 - 0.200in)
	AT60-16-06xx	AT62-16-06xx	16 - 20 AWG (1.0 - 0.5mm <sup>2</sup> )	1.40 - 2.54mm (0.055 - 0.100in)	3.81 - 5.08mm (0.150 - 0.200in)
	AT60-16-08xx	AT62-16-08xx	20 - 22AWG (0.5 - 0.35mm <sup>2</sup> )	1.20 - 2.10mm (0.047 - 0.083in)	3.81 - 5.08 mm (0.150 - 0.200in)
Size 20	AT60-20-01xx	AT62-20-01xx	16 - 22AWG (1.5 - 0.35mm <sup>2</sup> )	1.91 - 3.15mm (0.075 - 0.125in)	3.81 - 5.08mm (0.150 - 0.200in)
	AT60-20-02xx	AT62-20-02xx	16 - 22 AWG (1.5 - 0.35mm <sup>2</sup> )	1.30 - 2.16mm (0.051 - 0.085in)	3.81 - 5.08mm (0.150 - 0.200in)
	AT60-20-04xx	AT62-20-04xx	20 - 22 AWG (1.5 - 0.35mm <sup>2</sup> )	1.25 - 1.8mm (0.049 - 0.071in)	3.81 - 5.08mm (0.150 - 0.200in)

#### 3.5. Crimp

The contact must be crimped to the wire according to instructions packaged with the tooling. These requirements apply equally to the pin contact and the socket contact.

#### BELLMOUTH

The flare that is formed on the edge of the conductor crimp acts as a funnel for the wire strands. This funnel reduces the possibility that a sharp edge on the conductor crimp will cut or nick the wire strands. A rear bellmouth is required on the conductor crimp. A front bellmouth is optional. Caution: Excessively large bellmouths will reduce crimp area and reduce pull forces. See [Fig 2](#) for bellmouth specifications.

**A. Cutoff Tab**

This is the material that protrudes outside the insulation crimp after the terminal is separated from the carrier strip. A cut-off tab that is too long may expose a terminal outside the housing and it may fail electrical spacing requirements. In most situations, a tool is setup to provide a cut-off tab that shall not exceed the value indicated in [Fig 2](#).

**CAUTION:** Burrs on the cut-off tab are not allowed as they have the potential to cut mat seals.

**B. Wire Barrel Seam**

The wire barrel crimp must form a closed seam over the entire length of the wire barrel. (See [Fig 3](#))

**C. Wire Barrel Crimp**

The crimp applied to the wire barrel portion of the contact must be the most compressed area. All conductors within the wire barrel crimp must show evidence of compression. Good compression is guaranteed by following the given crimp dimensions, Figure 3. The crimp barrel is filled with the conductor strands. All conductor strands within the wire crimp must show evidence of compression. Voids due to unequal roll-in of the crimp barrel legs, uneven distribution of strands or unfavorable tolerance set of wire cross section area, crimp height and material thickness, are permissible. The crimped area must be symmetrical on both sides of the wire barrel. The thickness of the wall must be uniform. See 114-18022-10 for more information on how to make and evaluate F-crimp cross sections. The crimp barrel inside wall is formed to the shape of the strands for intimate contact. All existing wire strands are enclosed within the wire barrel. Any stranding outside the crimp barrel or broken strands outside the wire crimp are not permissible.

If low compression occurs, the number of strands has to be checked. To avoid over compression, which would favor wire barrel flash, the wire crimp height may not be beyond the limitation. All conductors must be centered within and held firmly inside the wire barrel. No strands can be folded back over the wire insulation. There must be no evidence of loose wire strands or wire strands visible in the seam. The wire insulation must not enter the contact wire barrel. (See [Fig 3](#)) For wire sizes, equal to or less than 14 AWG, the crimp is acceptable when each tip of the wire barrel wraps inward to form a curl that touches the inside of the wire barrel. (See [Fig 3](#))

The wire barrel crimp height and width must be within the dimensions provided in the [A Series™ Contacts - Stamped & Formed Crimp Specifications chart on page 10](#).

**D. Insulation Barrel Crimp**

The insulation barrel shall not have burrs. The insulation barrel crimp shall grip the wire insulation firmly.

The insulation barrel crimp (including the cutoff tab) must be equal to or less than the wire insulation outside diameter.

The wire stripping tool may leave corrugated indentations on the surface of the wire insulation. This is especially severe with cross-linked polyethylene (high-temperature) wire insulation. If the wire is positioned with these indentations at the connector wire seal, leakage may result. The wire insulation surface must be smooth and free of indentations within the area described in [Fig 3](#).

There may be a slight deformation of the wire insulation. There may be skewing of the wire insulation.

**Wire Barrel Flash**

Wire barrel flash is the formation that may appear on one side of the wire barrel as the result of the crimping process. It must not exceed the dimension provided in [Fig 2](#).

There must be no cracking at the bottom of the wire barrel—independent of the size of the flash.

**Bend Allowance**

The force applied during crimping may cause some bending between the crimped wire barrel and the mating portion of the contact. Such deformation is acceptable within the limits provided in [Fig 2](#).

The up-and-down bend of the crimped portion of the contact, including the cutoff tab and burr, and the side-to-side bend of the crimped contact must not be bent beyond the limits given.

Fig 2

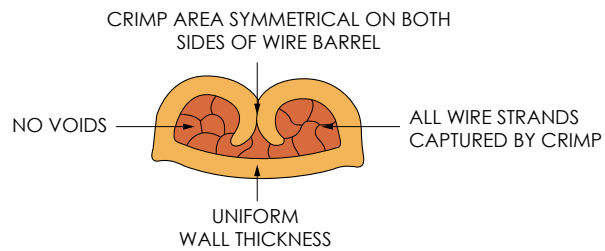
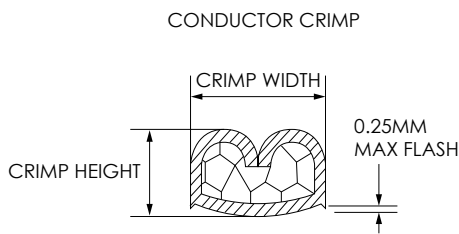
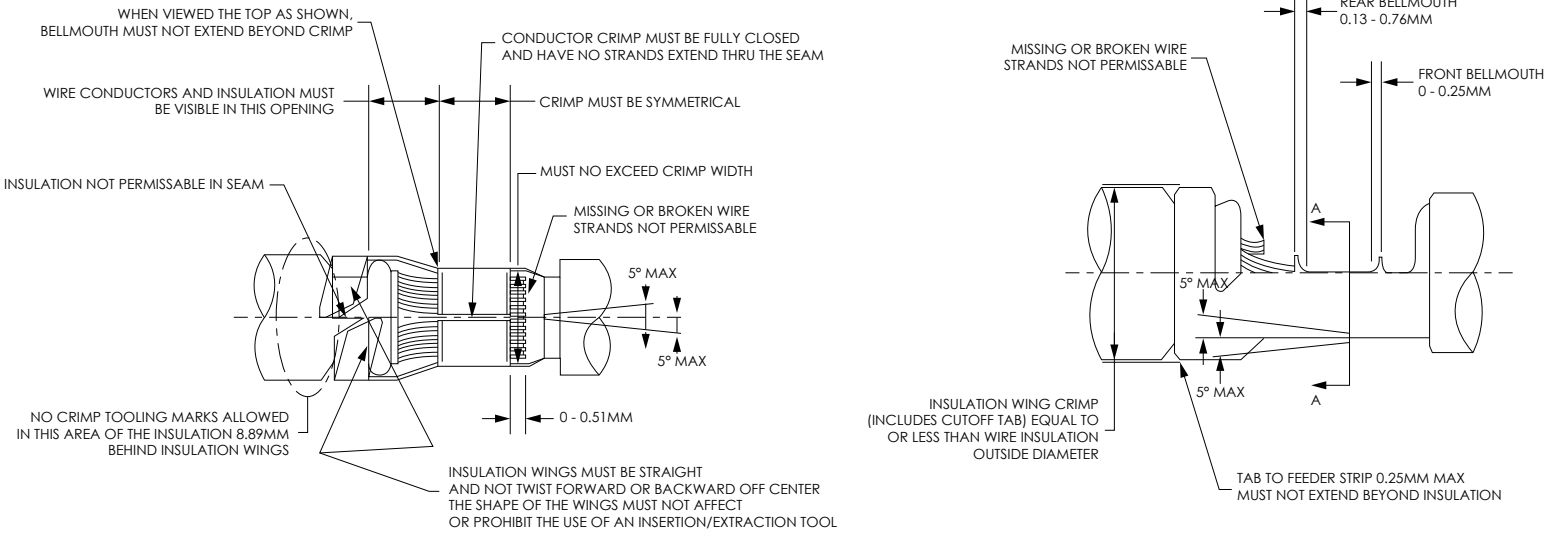

UNACCEPTABLE WIRE BARREL CRIMP

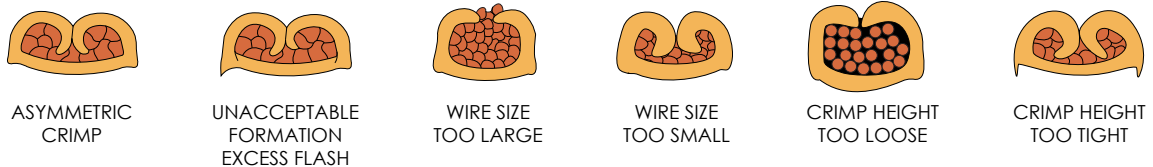
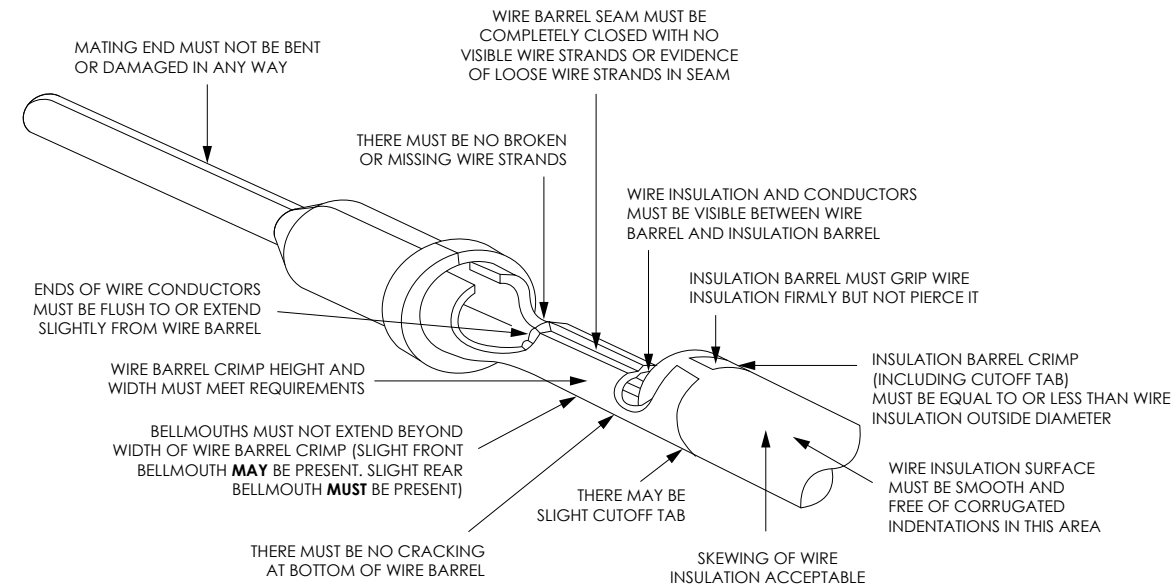

Fig 3

Contact Size	Pin PN	Socket PN	Wire Size AWG / mm <sup>2</sup>	
Size 12	AT60-12-01xx	AT62-12-01xx	< 14AWG	
Size 16	AT60-14-01xx	AT62-14-01xx	< 18AWG	
	AT60-16-01xx	AT62-16-01xx		
	AT60-16-06xx	AT62-16-06xx		
Size 20	AT60-20-01xx	AT62-20-01xx		
	AT60-20-02xx	AT62-20-02xx		
Size 20	AT60-20-04xx	AT62-20-04xx		



**5. Procedure**

General Measurement and Evaluation Requirements. See **Fig 4**

Crimp Height Measurement (Anvil Flash Evaluation)

**Step 1.** Complete tool set-up procedure.

**Step 2.** Crimp a minimum of 5 samples.

**Step 3.** Place the flat blade of the crimp micrometer across the center of the dual radii of the conductor crimp. Do not take the measurement near the conductor bell mouth (see Figure 4 5).

**Step 4.** Rotate the micrometer dial until the point contacts the bottom most radial surface. If using a calliper, be certain not to measure the conductor anvil flash (extrusions) of the crimp.

Fig 4

