

1-1456426-1 ✓ ACTIVE

MCON | MCON 1.2mm

TE Internal #: 1-1456426-1

12 V / 24 V / 48 V, 4 Position, Automotive Housing for Female Terminals, Wire-to-Board, 4 mm [.157 in] Centerline, Sealable, Black, MCON 1.2mm

[View on TE.com >](#)



Automotive Parts > Automotive Connectors > Automotive Housings > 48V Ready 1.2mm Sealed Connectors



Nominal Voltage Architecture: 12 V, 24 V, 48 V

Connector & Housing Type: **Housing for Female Terminals**

Number of Positions: 4

Sealable: **Yes**

Operating Temperature Range: -40 – 150 °C, -40 – 130 °C, -40 – 170 °C [-40 – 338 °F, -40 – 302 °F, -40 – 266 °F]

[All 48V Ready 1.2mm Sealed Connectors \(183\)](#)

Features

Product Type Features

Mixed & Hybrid Connector	No
Connector Shape	Rectangular
Connector & Housing Type	Housing for Female Terminals
Sealable	Yes
Primary Locking Feature	Clean Body
Connector System	Wire-to-Board
Connector & Contact Terminates To	Wire & Cable

Configuration Features

Number of Positions	4
Number of Rows	1

Electrical Characteristics

Nominal Voltage Architecture	12 V, 24 V, 48 V
------------------------------	------------------



Body Features

Primary Product Color	Black
Connector & Keying Code	A

Contact Features

Contact Size	1.2mm
Contact Type	Receptacle
Mating Tab Width	1.2 mm[.047 in]
Contact Current Rating (Max)	25 A

Mechanical Attachment

Strain Relief	Without
Terminal Position Assurance	Yes
Mating Alignment Type	Keyed
Mating Alignment	With
Connector Mounting Type	Cable Mount (Free-Hanging)

Housing Features

Housing Material	PA GF
Centerline (Pitch)	4 mm[.157 in]

Dimensions

Product Width	26.5 mm[1.04 in]
Product Length	24.7 mm[.972 in]
Connector Height	17.5 mm[.689 in]

Usage Conditions

Operating Temperature Range	-40 – 150 °C, -40 – 130 °C, -40 – 170 °C[-40 – 338 °F][-40 – 302 °F][-40 – 266 °F]
Operating Temperature (Max)	130 °C, 150 °C, 170 °C[266 °F][302 °F][338 °F]

Operation/Application

Circuit Application	Signal
---------------------	--------

Industry Standards

IP Rating	IP67
-----------	------

Other

Serviceable	Yes
-------------	-----



Connector Position Assurance Capable

No

Product Compliance

[For compliance documentation, visit the product page on TE.com>](#)

EU RoHS Directive 2011/65/EU	Compliant
EU ELV Directive 2000/53/EC	Compliant
China RoHS 2 Directive MIIT Order No 32, 2016	有害物质含量符合标准要求 No Restricted Substance(s) Above Threshold
EU REACH Regulation (EC) No. 1907/2006	Current ECHA Candidate List: JUNE 2025 (250) Candidate List Declared Against: JAN 2025 (247) Does not contain REACH SVHC
Halogen Content	Low Halogen - Br, Cl, F < 900 ppm per homogenous material. Also BFR/CFR/PVC Free
Solder Process Capability	Not applicable for solder process capability

Product Compliance Disclaimer

This information is provided based on reasonable inquiry of our suppliers and represents our current actual knowledge based on the information they provided. This information is subject to change. The part numbers that TE has identified as EU RoHS compliant have a maximum concentration of 0.1% by weight in homogenous materials for lead, hexavalent chromium, mercury, PBB, PBDE, DBP, BBP, DEHP, DIBP, and 0.01% for cadmium, or qualify for an exemption to these limits as defined in the Annexes of Directive 2011/65/EU (RoHS2). Finished electrical and electronic equipment products will be CE marked as required by Directive 2011/65/EU. Components may not be CE marked. Additionally, the part numbers that TE has identified as EU ELV compliant have a maximum concentration of 0.1% by weight in homogenous materials for lead, hexavalent chromium, and mercury, and 0.01% for cadmium, or qualify for an exemption to these limits as defined in the Annexes of Directive 2000/53/EC (ELV). Regarding the REACH Regulation, the information TE provides on SVHC in articles for this part number is based on the latest European Chemicals Agency (ECHA) 'Guidance on requirements for substances in articles' posted at this URL: <https://echa.europa.eu/guidance-documents/guidance-on-reach>

Compatible Parts

TE Part # 1924956-2
4 Pos Sld 1.2mm cb MCON Peri Seal 40 Dur

TE Part # 967067-2
MQS EINZELLEITDICHT

TE Part # CAT-M4595-T273
MCON Receptacle and Tab

TE Part # 1456427-1
4 Pos Sld 1.2mm cb MCON Key A in-hsg

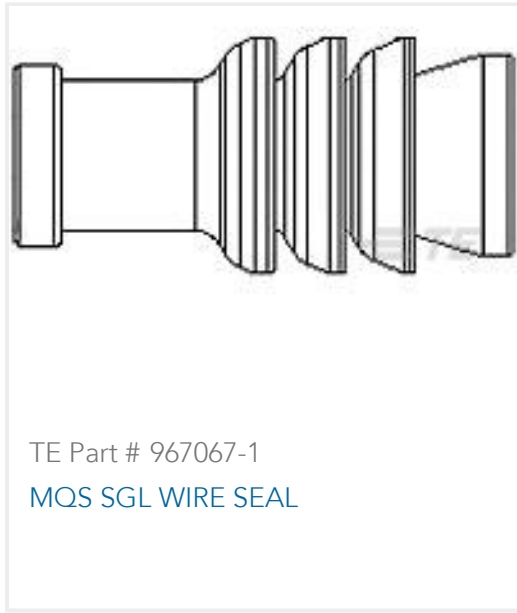

Also in the Series | **MCON 1.2mm**

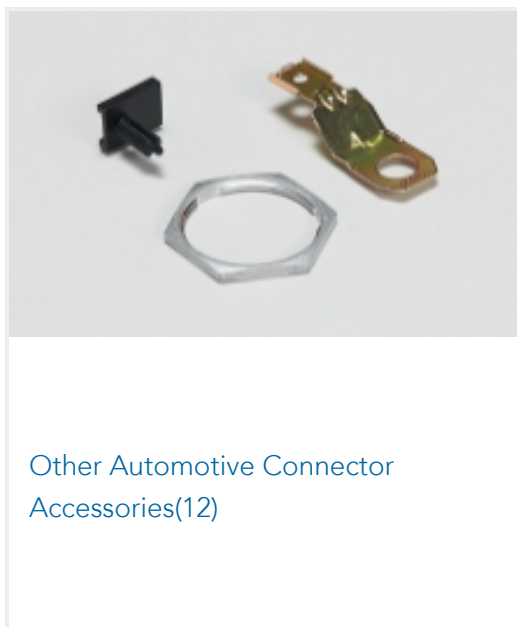
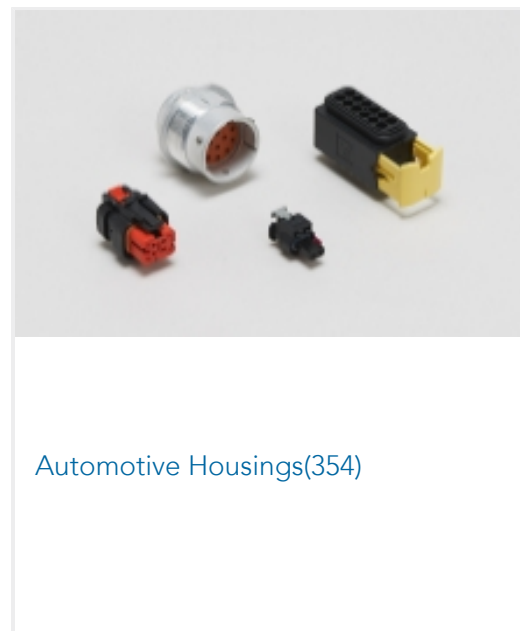

Customers Also Bought

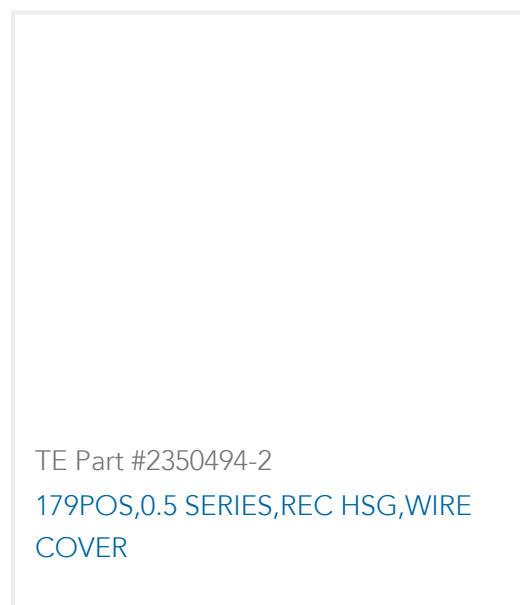
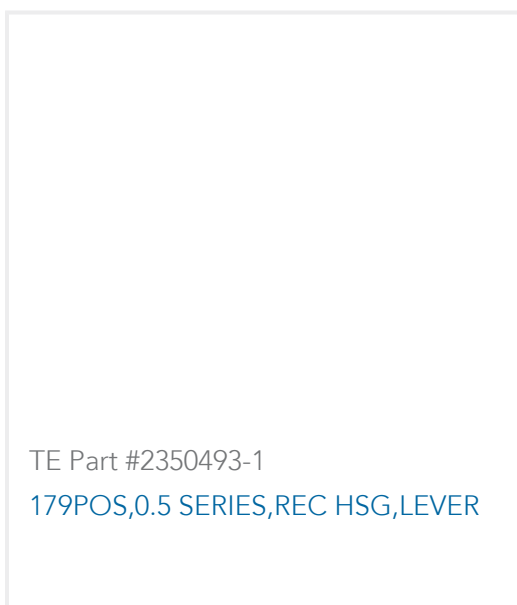

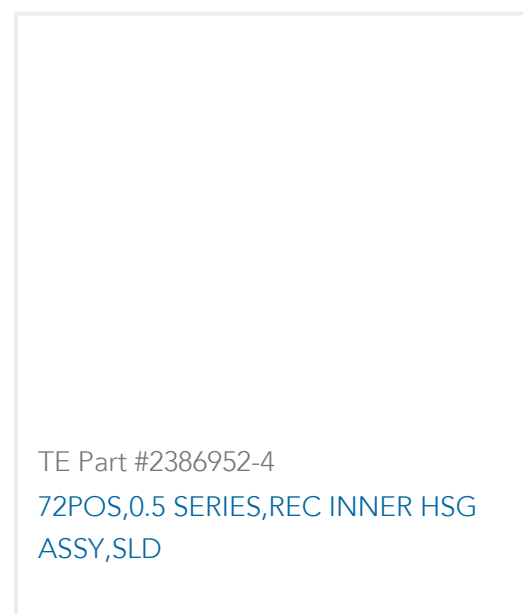
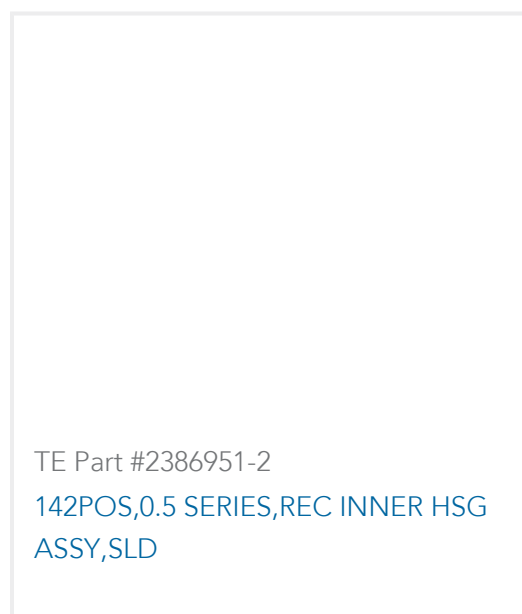

Documents

Product Drawings

[4POS, MCON 1.2 CB REC 2p TL SEALED](#)

English

CAD Files

Customer View Model

[ENG_CVM_CVM_1-1456426-1_B.2d_dxf.zip](#)

English

[3D PDF](#)

3D

Customer View Model

[ENG_CVM_CVM_1-1456426-1_B.3d_igs.zip](#)

English

Customer View Model

[ENG_CVM_CVM_1-1456426-1_B.3d_stp.zip](#)

English

By downloading the CAD file I accept and agree to the [Terms and Conditions](#) of use.

Instruction Sheets

[Instruction Sheet \(U.S.\)](#)

English

[Instruction Sheet \(U.S.\)](#)

English