

AMPMODU Interconnection System

RoHS
Ready 

 **Tyco Electronics**
Our commitment. Your advantage.

Table of Contents

PC/104 and PC/104-Plus Connectors
1

Disclaimer

While Tyco Electronics Corporation and its affiliates referenced herein ("Tyco Electronics") have made every reasonable effort to confirm the accuracy of the information in this catalog, Tyco Electronics does not guarantee that it is error-free, nor does Tyco Electronics make any other representation, warranty or guarantee that the information is accurate, correct, reliable or current.

.050 x .050 [1.27 x 1.27] Centerline
2

Tyco Electronics reserves the right to make any adjustments to the information contained herein at any time without notice. Tyco Electronics expressly disclaims all implied warranties regarding the information contained herein, including, but not limited to, any implied warranties of merchantability or fitness for a particular purpose. Tyco Electronics' only obligations are those in the Tyco Electronics Standard Terms and Conditions of Sale, and in no case will Tyco Electronics be responsible for any incidental, indirect, or consequential damages arising from the sale, resale, use or misuse of its products. Users should independently evaluate the suitability of, and test each product for, their application.

.050 x .100 [1.27 x 2.54] Centerline
3

The dimensions, specifications, designs, construction, materials and processes in this catalog are for reference purposes only and are subject to change without notice. Please consult Tyco Electronics for the most current product information.

AMPMODU 2mm Connectors
4

The export of certain Tyco Electronics products is restricted by the Arms Export Control Act (Title 22, U.S.C. Sec 2751, et seq.) or the Export Administration Act of 1979, as amended (Title 50, U.S.C., App. 2401 et seq.). Orders may be subject to export approval by the U.S. Government. Buyer must comply with all applicable export laws of all applicable jurisdictions.

.100 x .100 [2.54 x 2.54] Centerline
5

© 2008 and 2004 Tyco Electronics Corporation. All Rights Reserved.

.125 x .125 [3.18 x 3.18] Centerline
6

AMP, ACTION PIN, AMP-LATCH, AMP-O-ELECTRIC, AMP-O-MATIC, AMPLIMITE, AMPMODU, AMPOMATOR, CERTI-CRIMP, CHAMPOMATOR, PRO-CRIMPER, R-CAM, TE LOGO and TYCO ELECTRONICS are trademarks of Tyco Electronics Corporation.

.156 [3.96] Centerline
7

Other products, logos, and company names mentioned herein may be trademarks of their respective owners.

See inside back cover for Global Contacts and phone numbers.

Shunts
8

1	PC/104 and PC/104-Plus Connectors	
	Introduction	5
	PC/104, Press Fit	6, 7
	PC/104-Plus, Press Fit	8, 9
	PC/104, Solder	10
	PC/104-Plus, Solder	11
	Accessories, Kits	12
2	0.050 [1.27] x 0.050 [1.27] CENTERLINE AMPMODU 50/50 Grid	
	Board-to-Board Vertical Receptacles and Headers:	
	Introduction	13, 14
	Vertical Receptacles, Double Row	15
	Vertical Headers, Double Row	16
	Recommended PC Board Layouts	17
	Board-to-Board Right-Angle Headers:	
	Introduction	18
	Right-Angle Headers, Double Row, Latching and Non-Latching	19
	Cable-to-Board Connectors:	
	Introduction	20
	Receptacle Connectors, Double Row, With and Without Latch	21
	Cable Connector Terminating Cover, Double Row	22
	IDC (Insulation Displacement Crimp) Tooling	23
	Performance Specifications	24
	Technical Documents	24
3	.050 [1.27] x 0.100 [2.54] CENTERLINE AMPMODU System 50	25
	Board-to-Board Connectors, Thru-Hole:	
	Introduction	26
	Headers, Shrouded and Unshrouded	27-35
	Introduction	36
	Receptacles	37-40
	PC Board Hole Layouts	41, 42
	Board-to-Board Connectors, Surface-Mount:	
	Introduction	43
	Headers	44
	Receptacles	45
	Cable-to-Board Connectors, FFC Cable:	
	Introduction	46
	Flexible Flat Conductor Cable	47
	FFC Contacts	48
	Receptacle Housings	49-52
	ZIF-Line Connectors	53, 54
	Cable-to-Board Connectors, Ribbon Cable:	
	Introduction	55
	Ribbon Cable Receptacles	56
	Paddleboard Receptacles	57
	Flat Ribbon Cable	58, 59
	Application Tooling for Flex Film Contacts	60
	Application Tooling	60-62
	Performance Specifications	63
	Technical Documents	64

Table of Contents (Continued)

4	AMPMODU 2mm Connectors	
	AMPMODU 2mm Connectors (Board to Board)	65
	Headers, Unshrouded, Double Row, Thru-Hole Mount	66, 67
	Breakaway Headers, Unshrouded, Double Row, Thru-Hole Mount	68-70
	Breakaway Headers, Unshrouded, Double Row, Surface Mount	71, 72
	Stacking Header, Unshrouded, Double Row, Thru-Hole Mount	73
	Headers, Shrouded, Double Row, Thru-Hole, Right-Angle Mount	74, 75
	Headers, Shrouded, Double Row, Surface Mount	76, 77
	Headers, Shrouded, Double Row, Thru-Hole Mount with Cable Shrouds	78, 79
	Receptacles, Double Row, Thru-Hole, Vertical Mount	80, 81
	Receptacles, Double Row, Surface Mount, Right-Angle Mount	82
	Receptacles, Double Row, Thru-Hole, Right-Angle Mount	83
	Receptacles, Double Row, Surface Mount, Vertical Mount	84
5	.100 [2.54] x .100 [2.54] CENTERLINE	
	Introduction	85-87
	Terms Explained	87
	Wire Sizes	88
	Contact Platings	88
	Mating Post Lengths	88
	Application Tooling	88
	Board-to-Board Solutions Guides, .100[2.54] Centerline Products	89
	Wire-to-Board Solutions Guide, .100[2.54] Centerline Products	89
	Mating Post Selection Guide	90
	Parallel Stacking Guide for Board-to-Board Applications	91
	Board-to-Board Products:	
	Unshrouded Headers	92-100
	Breakaway and Retention Headers-Unshrouded	101-105
	Reeled Breakaway Headers	106, 107
	Surface Mount Breakaway Headers	108-110
	Unshrouded Stacking Headers- Breakaway	111-113
	Shrouded Headers	114-140
	Standard Profile	114-133
	Low Profile	134-140
	Shrouded Stacking Headers	141-144
	ACTION PIN Headers	145-149
	ACTION PIN Press-Fit Posts	150, 151
	Application Tooling for ACTION PIN Posts	152, 153
	ACTION PIN Stacking Connectors	154-161
	Application Tooling for AMP ACTION PIN Stacking Connectors	162
	0.025 [0.64] Square Posts	163
	0.025 [0.64] Square Continuous Posts	164, 165
	0.045 [1.14] Square Continuous Posts	166, 167
	Horizontal Mount Receptacle Assemblies, Mod II	168-173
	Vertical Mount Receptacle Assemblies, Mod II & Mod IV	174-184
	Surface Mount Vertical Receptacles, Mod IV	185-192
	Two-Piece Printed Circuit Board Connectors	193-202
	Accessories	203-205
	Wire-to-Board Products:	
	Locking Clip Contacts and Housings	206-209
	Mod IV Contacts and Housings	210-220
	Short Point Contacts and Housings	221-224
	MTE Interconnection System	225-250
	Surface Mount MTE Headers (Right-Angle & Vertical)	251, 252
	Interchangeable Contacts, Wire Crimp (Snap-In)	253, 254
	MT and Shielded MT Connectors	255-265
	Mini-Tandem Spring Receptacle Contacts	266-269
	Application Tooling	270-275
	Technical Documents	276-278

1	PC/104 and PC/104-Plus Connectors
2	.050 x .050 [1.27 x 1.27] Centerline
3	.050 x .100 [1.27 x 2.54] Centerline
4	AMPMODU 2mm Connectors
5	.100 x .100 [2.54 x 2.54] Centerline
6	.125 x .125 [3.18 x 3.18] Centerline
7	.156 [3.96] Centerline
8	Shunts

Table of Contents (Continued)

PC/104 and PC/104-Plus Connectors
1

.050 x .050 [1.27 x 1.27] Centerline
2

.050 x .100 [1.27 x 2.54] Centerline
3

AMPMODU 2mm Connectors
4

.100 x .100 [2.54 x 2.54] Centerline
5

.125 x .125 [3.18 x 3.18] Centerline
6

.156 [3.96] Centerline
7

Shunts
8

6 .125 [3.18] x .125 [3.18] CENTERLINE
Wire-to-Board Product:
Level V IDC Connectors279-282

7 .156 [3.96] CENTERLINE
Mod I 0.031 x 0.062 Interconnection System
Introduction283, 284
Receptacles, Vertical and Horizontal Board Mount285, 286
Receptacle Assemblies, Vertical and Horizontal Board Mount287-289
Receptacles, Crimp Snap-In (Wire Applied)290
Receptacle Housings, Standard Profile-Unkeyed (With/Without Strain Relief) ...291, 292
Receptacle Housings, Low Profile-Keyed293
Posts, Machined Applied294
Headers:
 Straight Post, Keyed295, 296
 Right-Angle, Keyed297
Locking Clip Contacts, Crimp Snap-In (Wire Applied)298
Locking Clip Connector Housings, Single Row, Crimp Snap-In299
Application Tooling300-304
Performance Specifications305
Technical Documents305

8 Shunts
Dual In-Line Package DIP Shunts306, 307
Post Shunts308-310
Performance Specifications311
Technical Documents311
Part Number Index313-316

Restriction on the use of Hazardous Substances (RoHS)

At Tyco Electronics, we're ready to support your RoHS requirements. We've assessed more than 1.5 million end items/components for RoHS compliance, and issued new part numbers where any change was required to eliminate the restricted materials. Part numbers in this catalog are identified as:

RoHS Compliant — Part numbers in this catalog are RoHS Compliant, unless marked otherwise. These products comply with European Union Directive 2002/95/EC as amended 1 January 2006 that restricts the use of lead, mercury, cadmium, hexavalent chromium, PBB, and PBDE in certain electrical and electronic products sold into the EU as of 1 July 2006.

NOTE: For purposes of this Catalog, included within the definition of RoHS Compliant are products that are clearly "Out of Scope" of the RoHS Directive such as hand tools and other non-electrical accessories.

NOTE: Information regarding RoHS compliance is provided based on reasonable inquiry of our suppliers and represents our current actual knowledge based on the information provided by our suppliers. This information is subject to change. For latest compliance status, refer to our website referenced at right.

Getting the Information You Need

Our comprehensive on-line RoHS Customer Support Center provides a forum to answer your questions and support your RoHS needs. A RoHS FAQ (Frequently Asked Questions) is available with links to more detailed information. You can also submit RoHS questions and receive a response within 24 hours during a normal work week. The Support Center also provides:

- Cross-Reference from Non-compliant to Compliant Products
- Ability to browse RoHS Compliant Products in our on-line catalog
- Downloadable Technical Data Customer Information Presentation
- More detailed information regarding the definitions used above
- So whatever your questions when it comes to RoHS, we have the answers at www.tycoelectronics.com/leadfree



PC/104 and PC/104-Plus Connectors

Product Facts

- Press fit design — eliminates hand soldering
- Unitized PC/104 connector assembly — eliminates two piece (64 pin & 40 pin) configuration
- Integral board spacers with captive hardware — eases & improves assembly efficiency while minimizing stocked hardware
- “Flat-rock” insertable — no need for complex insertion tooling
- Recognized by Underwriters' Laboratories to US and Canadian standards  file No. E28476
- Fully compliant with PC104 & PC104-Plus standards
- Solutions available for lead free processes (ie. ENIG and silver immersion plated PCB's)

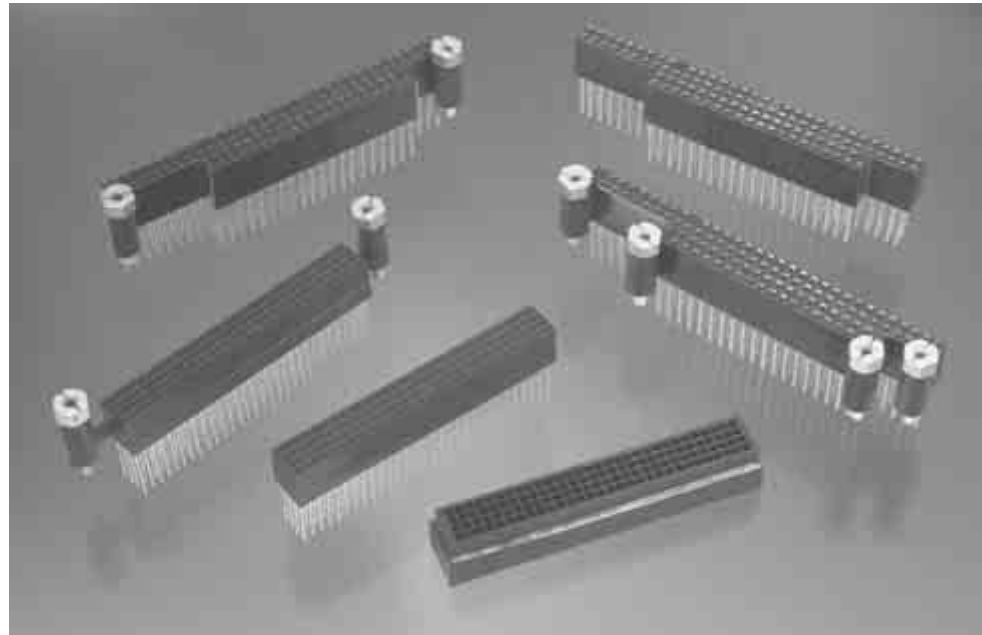
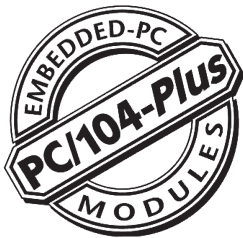

The PC/104 and PC/104-Plus connectors are industry standard product offerings which comply with the interconnection requirements defined by the PC/104 organization (<http://www.pc104.org>)

Both products are designed specifically for “flat-rock” press-fit installation for ease of application. Solder version is also available.

Optional integral standoffs minimize the customer's system assembly time.

The Tyco Electronics offering of the standard PC/104 product is a unitized connector rather than the two piece, 40 and 64 position connectors currently on the market. Customer needs to stock and apply only one part number rather than two.

Performance Specifications

Electrical Characteristics

Meets requirements of PC/104 and PC/104-Plus standards

Nominal Resistance — 10 milliohms maximum, ΔR

Insulation Resistance — 1000 megohms minimum

Dielectric Withstanding Voltage — 500 VAC for 1 min. at sea level

Mechanical Characteristics

Meets requirements of PC/104 and PC/104-Plus standards

Current — Signal application only

Temperature — -55° to 105°C

Material and Finish

Housing — Black Thermoplastic, UL 94V-0

Contact — Phosphor Bronze, Full Gold all over Nickel (stackthrough), Gold on mating end, Tin or Tin-lead on PCB tail all over Nickel (non-stackthrough)

Need more information?

Call Technical Support 1-800-522-6752:

Technical Support is staffed with specialists well versed in all Tyco Electronics products. The Center can provide you with:

- Technical Support
- Catalogs
- Technical Documents
- Tyco Electronics Authorized Distributor Locations

Technical Documents

Product Specifications

108-1956

Application Specifications

114-13021

Connector	Centerline	Position
PC/104	.100 2.54	104*
PC/104-Plus	.079 2.0	120**

*Two circuits plugged per PC/104 specification. Other options available.

**One circuit plugged per PC/104-Plus specification. Other options available.

PC/104, Press-Fit

Material and Finish

Housing — Glass filled thermoplastic, Black, 94V-0 rated

Contacts

Stackthrough — Phosphor Bronze; plated .000015 [0.00038] min. Gold on mating receptacle end, .000005 [0.000130] min. Gold on remainder, all over .000050 [0.00127] Nickel

or
Phosphor Bronze; plated .000015 [0.00038] min. Gold on mating receptacle end, .000100-.000200 [0.000254-.000508] matte tin on compliant section, .000005 [0.000130] min. Gold on remainder of post, all over .000050 [0.00127] Nickel

Non-Stackthrough — Phosphor Bronze; plated .000015 [0.00038] min. Gold on mating receptacle end, .000100 [0.00254] matte tin or tin-lead on remainder, all over .000050 [0.00127] Nickel

Screwlocks — Steel, Clear Chromate over Zinc

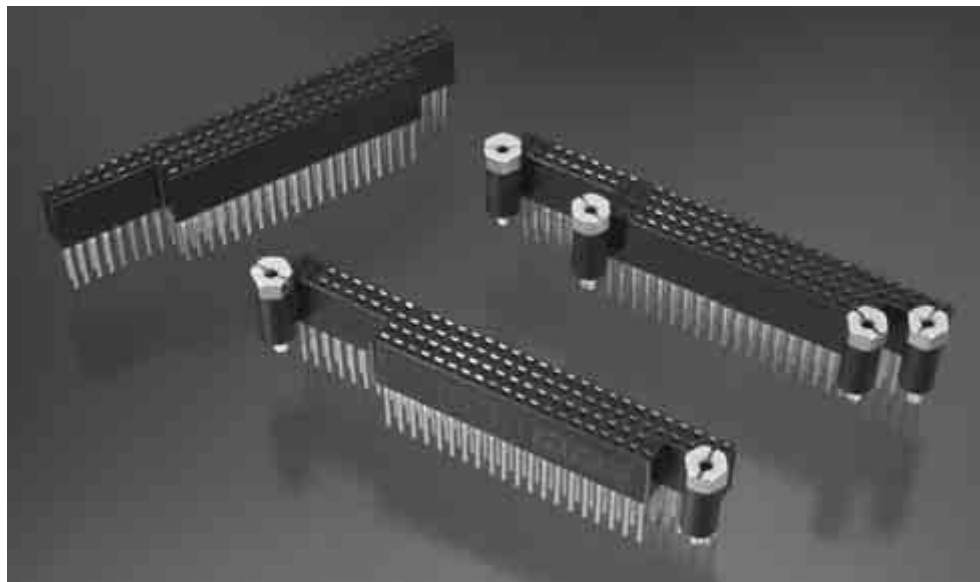

Stackthrough, No Standoffs

Gold plated contacts*

Part No. 1375795-1 (keyed), **Part No. 1375795-2** (unkeyed)

Gold plated contacts with Tin plated compliant pin section**

Part No. 1375795-3 (keyed), **Part No. 1375795-4** (unkeyed)

Non-Stackthrough, No Standoffs

Tin-lead plated tails*

Part No. 1375796-1 (keyed), **Part No. 1375796-2** (unkeyed)

Matte tin plated tails**

Part No. 1375796-3 (keyed), **Part No. 1375796-4** (unkeyed)

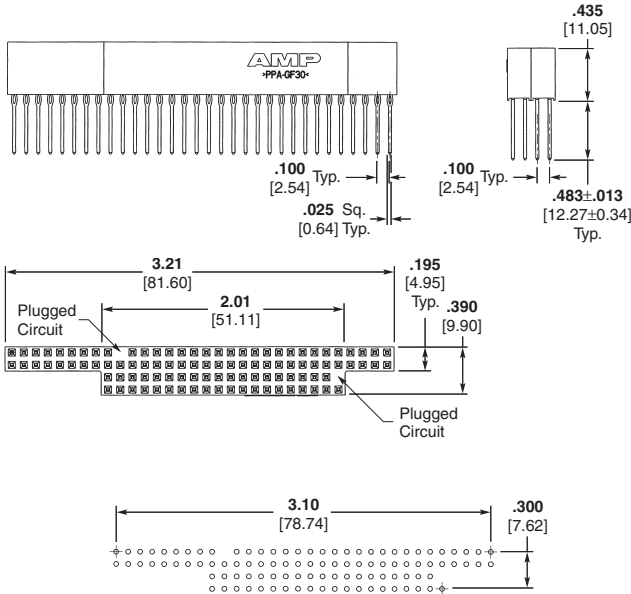

Keyed

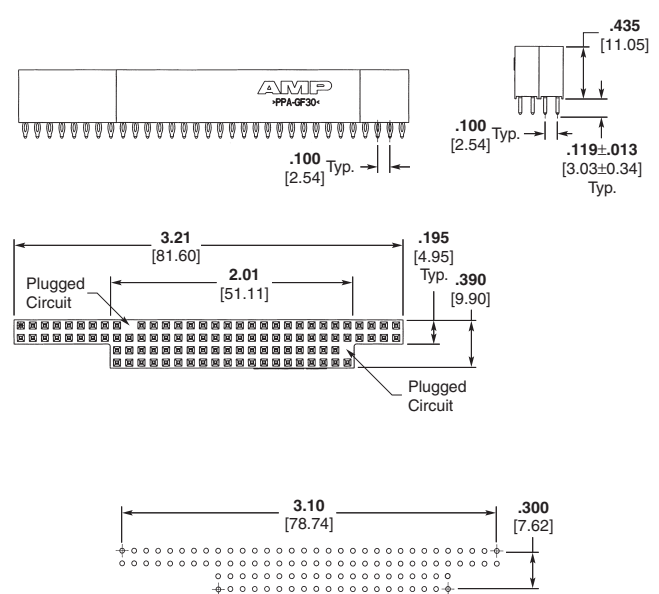

Unkeyed

Recommended PC Board Layout
See Customer Drawing for
Hole Geometry and Recommended Plating.

Note: All part numbers are RoHS compliant.

* For RoHS exempt Tin-lead processes (including ENIG Plated PCB's)

** for Silver Immersion processes or where a total lead free solution is desired

PC/104, Press-Fit (Continued)

Stackthrough, 2 Standoffs

Gold plated contacts*

Part No. 1375793-1 (keyed), Part No. 1375793-2 (unkeyed)

Gold plated contacts with Tin plated compliant pin section**

Part No. 1375793-3 (keyed), Part No. 1375793-4 (unkeyed)

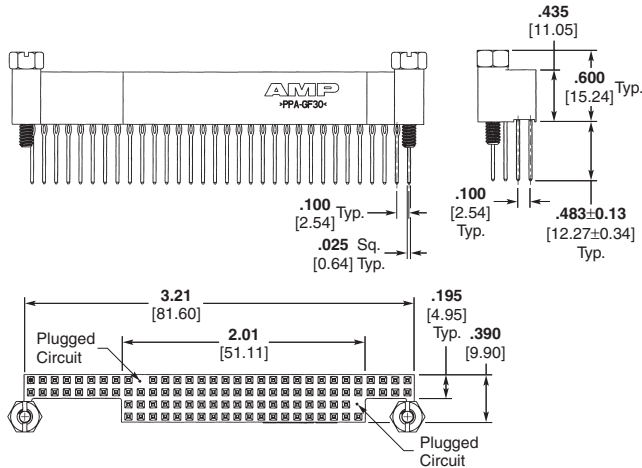

Non-Stackthrough, 2 Standoffs

Tin-lead plated tails*

Part No. 1375794-1 (keyed), Part No. 1375794-2 (unkeyed)

Matte tin plated tails**

Part No. 1375794-3 (keyed), Part No. 1375794-4 (unkeyed)

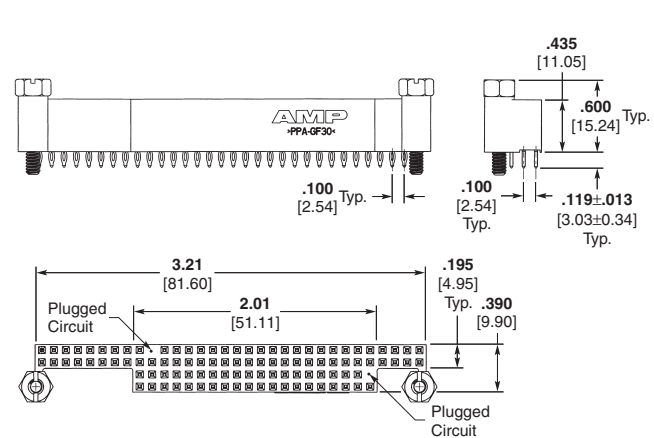

Stackthrough, 4 Standoffs

Gold plated contacts*

Part No. 1375791-1 (keyed), Part No. 1375791-2 (unkeyed)

Gold plated contacts with Tin plated compliant pin section**

Part No. 1375791-3 (keyed), Part No. 1375791-4 (unkeyed)

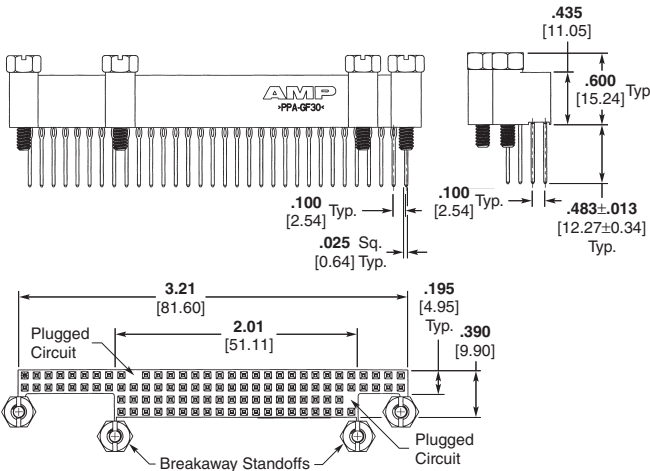

Non-Stackthrough, 4 Standoffs

Tin-lead plated tails*

Part No. 1375792-1 (keyed), Part No. 1375792-2 (unkeyed)

Matte tin plated tails**

Part No. 1375792-3 (keyed), Part No. 1375792-4 (unkeyed)

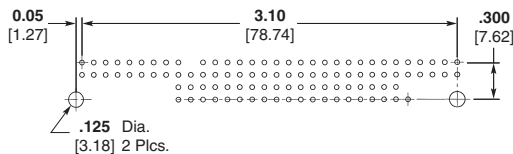
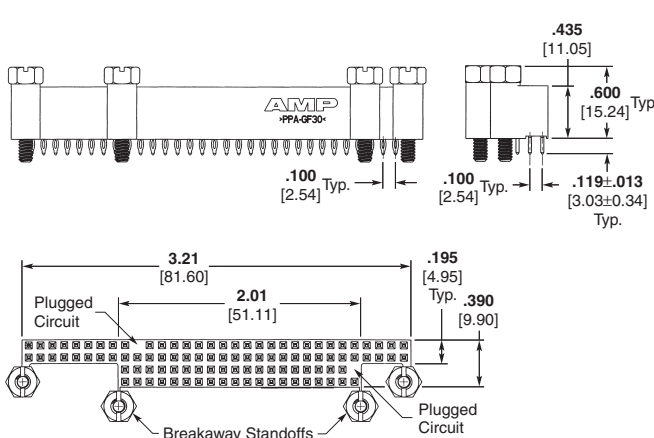

Keyed

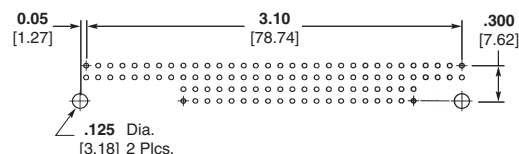

Unkeyed

Recommended PC Board Layout
See Customer Drawing for
Hole Geometry and Recommended Plating.

Note: All part numbers are RoHS compliant.

* For RoHS exempt Tin-lead processes (including ENIG Plated PCB's)

** for Silver Immersion processes or where a total lead free solution is desired

PC/104-Plus, Press-Fit

Material and Finish

Housing — Glass filled thermoplastic, Black, 94V-0 rated

Contacts

Stackthrough — Phosphor Bronze; plated .000015 [0.00038] min. Gold on mating receptacle end, .000005 [0.000130] min. Gold on remainder, all over .000050 [0.00127] Nickel

or
Phosphor Bronze; plated .000015 [0.00038] min. Gold on mating receptacle end, .000100-.000200 [0.000254-.000508] matte tin on compliant section, .000005 [0.000130] min. Gold on remainder of post, all over .000050 [0.00127] Nickel

Non-Stackthrough — Phosphor Bronze; plated .000015 [0.00038] min. Gold on mating receptacle end, .000100 [0.00254] matte tin or tin-lead on remainder, all over .000050 [0.00127] Nickel

Screwlocks — Steel, Clear Chromate over Zinc

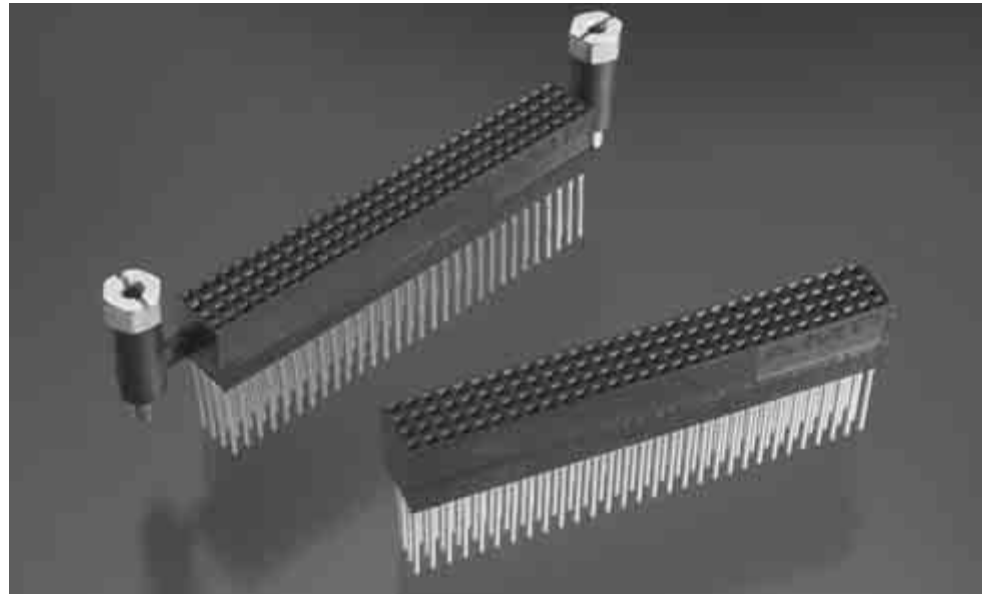

Stackthrough, No Standoffs

Gold plated contacts*

- Part No. 1375799-1** (unkeyed)
- Part No. 1375799-2** (keyed-A1) per PC/104-Plus specification
- Part No. 1375799-3** (keyed-D30) per PC/104-Plus specification

Gold plated contacts with Tin plated compliant pin section**

- Part No. 1375799-4** (unkeyed)
- Part No. 1375799-5** (keyed-A1) per PC/104-Plus specification
- Part No. 1375799-6** (keyed-D30) per PC/104-Plus specification

Non-Stackthrough, No Standoffs

Tin-lead plated tails*

- Part No. 1375800-1** (unkeyed)
- Part No. 1375800-2** (keyed-A1) per PC/104-Plus specification
- Part No. 1375800-3** (keyed-D30) per PC/104-Plus specification

Matte tin plated tails**

- Part No. 1375800-4** (unkeyed)
- Part No. 1375800-5** (keyed-A1) per PC/104-Plus specification
- Part No. 1375800-6** (keyed-D30) per PC/104-Plus specification

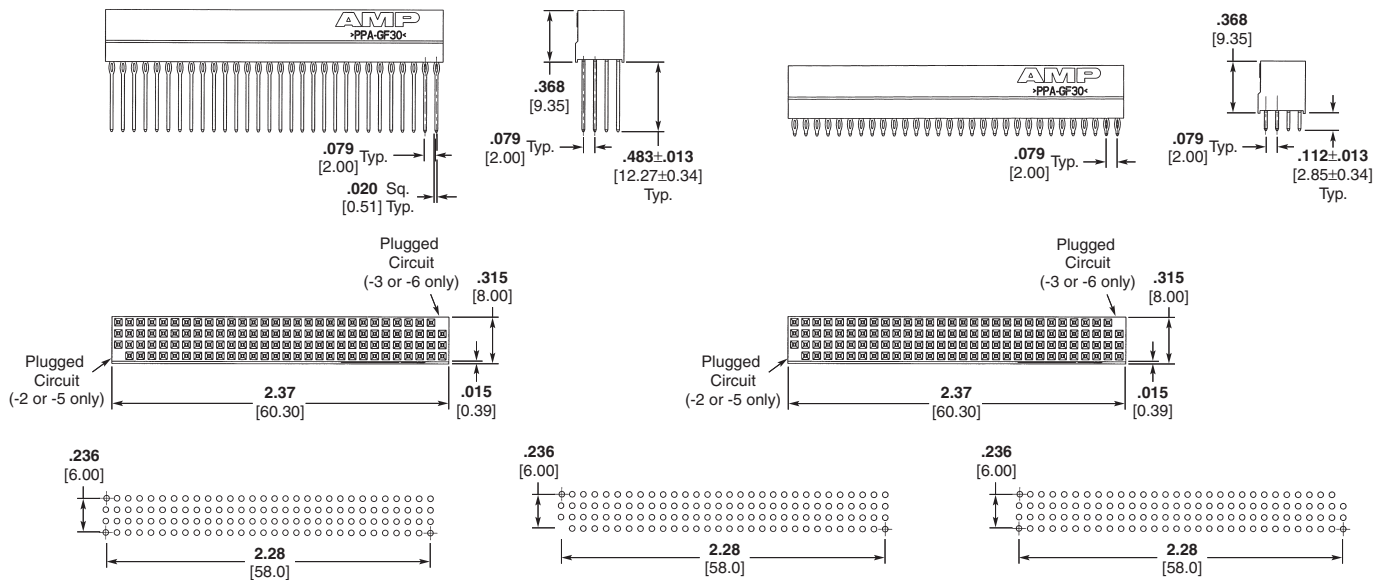

Recommended PC Board Layout for 1375799-1, 1375799-4, 1375800-1, 1375800-4

Recommended PC Board Layout for 1375799-2, 1375799-5, 1375800-2, 1375800-5

Recommended PC Board Layout for 1375799-3, 1375799-6, 1375800-3, 1375800-6

See Customer Drawing for Hole Geometry and Recommended Plating. (Including ENIG plated PCB's)

Note: All part numbers are RoHS compliant.

* For RoHS exempt Tin-lead processes (including ENIG Plated PCB's)

** for Silver Immersion processes or where a total lead free solution is desired

PC/104-Plus, Press-Fit (Continued)

Non-Stackthrough, 2 Standoffs

- Tin-lead plated tails*
- Part No. 1375798-1** (unkeyed)
- Part No. 1375798-2** (keyed-A1)
per PC/104-Plus specification
- Part No. 1375798-3** (keyed-D30)
per PC/104-Plus specification

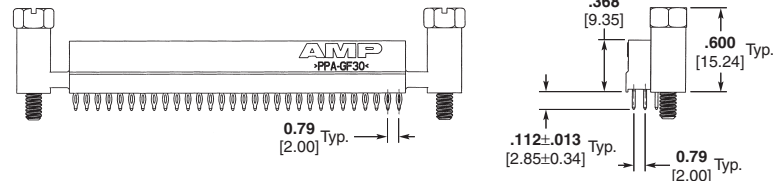

Matte tin plated tails**

- Part No. 1375798-4** (unkeyed),
- Part No. 1375798-5** (keyed-A1)
per PC/104-Plus specification
- Part No. 1375798-6** (keyed-D30)
per PC/104-Plus specification

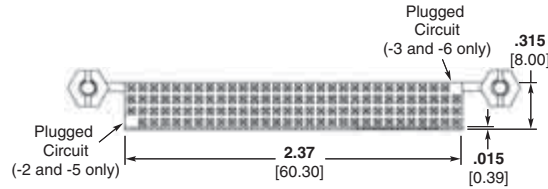

Stackthrough, 2 Standoffs

- Gold plated contacts*
- Part No. 1375797-1** (unkeyed)
- Part No. 1375797-2** (keyed-A1)
per PC/104-Plus specification
- Part No. 1375797-3** (keyed-D30)
per PC/104-Plus specification

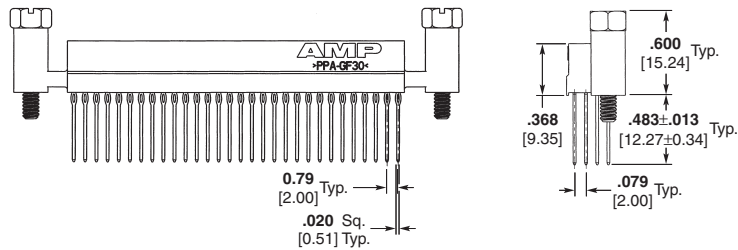

Gold plated contacts with Tin plated compliant pin section**

- Part No. 1375797-4** (unkeyed)
- Part No. 1375797-5** (keyed-A1)
per PC/104-Plus specification
- Part No. 1375797-6** (keyed-D30)
per PC/104-Plus specification

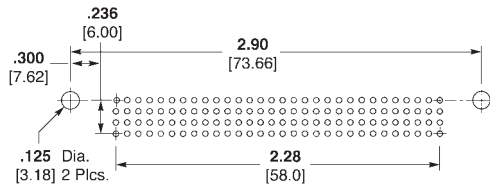
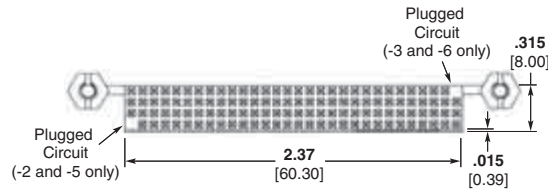

Recommended PC Board Layout
for 1375797-1, 1375797-4,
1375798-1, 1375798-4

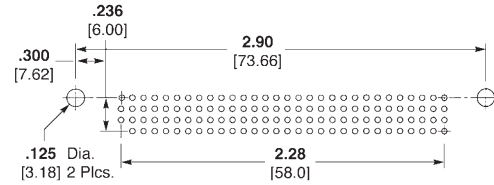

Recommended PC Board Layout
for 1375797-2, 1375797-5,
1375798-2, 1375798-5

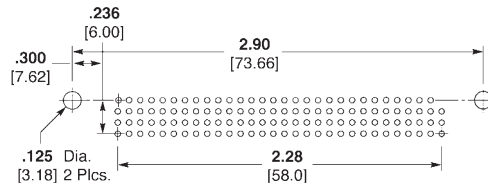

Recommended PC Board Layout
for 1375797-3, 1375797-6,
1375798-3, 1375798-6

See Customer Drawing for
Hole Geometry and Recommended Plating.

Note: All part numbers are RoHS compliant.

* For RoHS exempt Tin-lead processes (including ENIG Plated PCB's)

** for Silver Immersion processes or where a total lead free solution is desired

PC/104, Solder

Material and Finish

Housing — Glass filled thermoplastic, Black, 94V-0 rated

Contacts

Non-Stackthrough — Phosphor Bronze; plated .000015 [0.00038] min. Gold on mating receptacle end, .000100 [0.00254] matte tin on remainder, all over .000050 [0.00127] Nickel

Screwlocks — Steel, Clear Chromate over Zinc

Non-Stackthrough, No Standoffs

Part No. 1375963-3 (keyed)
Part No. 1375963-4 (unkeyed)

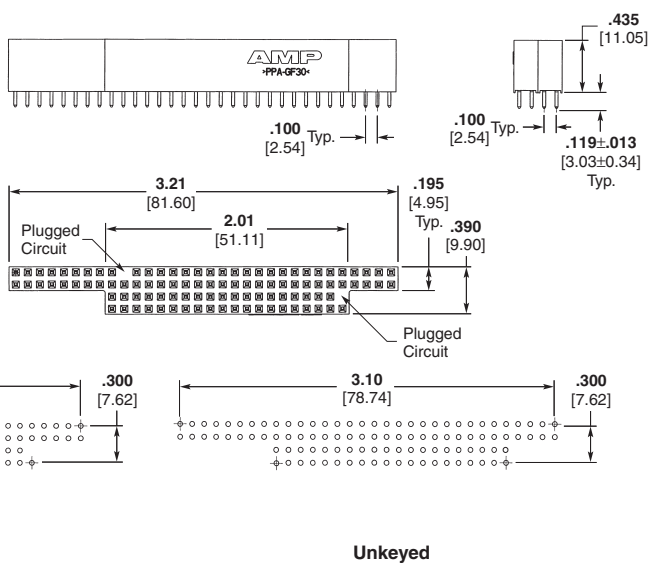

Recommended PC Board Layout

Non-Stackthrough, 2 Standoffs

Part No. 1375961-3 (keyed)
Part No. 1375961-4 (unkeyed)

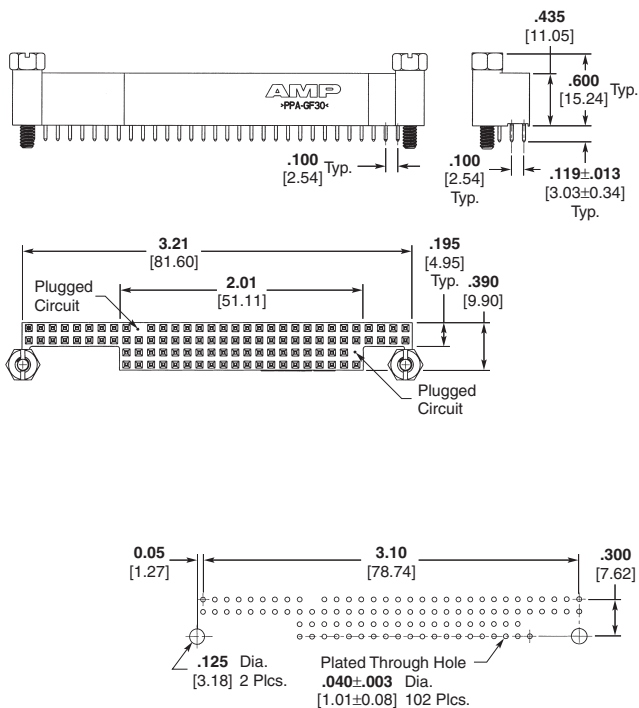

Keyed

Unkeyed

Recommended PC Board Layout

Non-Stackthrough, 4 Standoffs

Part No. 1375959-3 (keyed)
Part No. 1375959-4 (unkeyed)

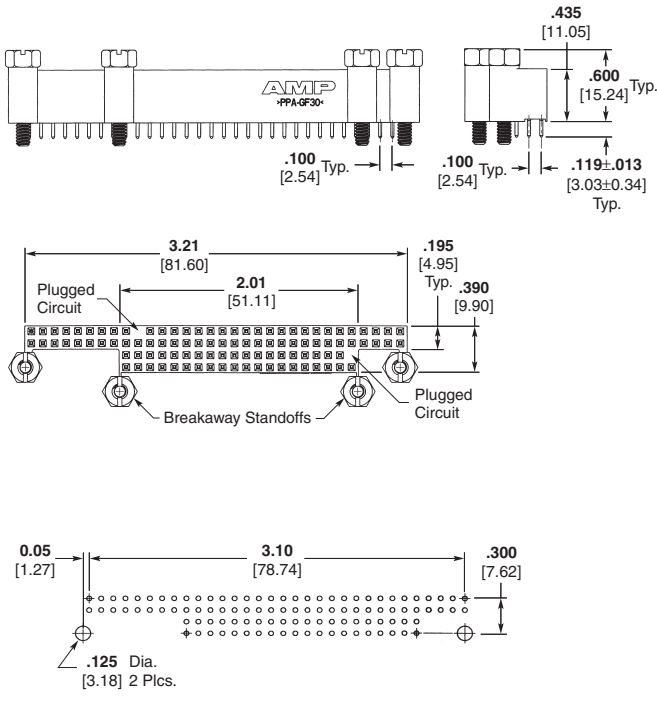

Note: All part numbers are RoHS compliant.

PC/104-Plus, Solder

Material and Finish

Housing — Glass filled thermoplastic, Black, 94V-0 rated

Contacts

Non-Stackthrough — Phosphor Bronze; plated .000015 [0.00038] min. Gold on mating receptacle end, .000100 [0.00254] matte tin on remainder, all over .000050 [0.00127] Nickel

Screwlocks — Steel, Clear Chromate over Zinc

Non-Stackthrough, No Standoffs

Part No. 1375967-4 (unkeyed)

Part No. 1375967-5 (keyed-A1)

per PC/104-Plus specification

Part No. 1375967-6 (keyed-D30)

per PC/104-Plus specification

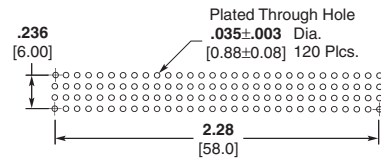
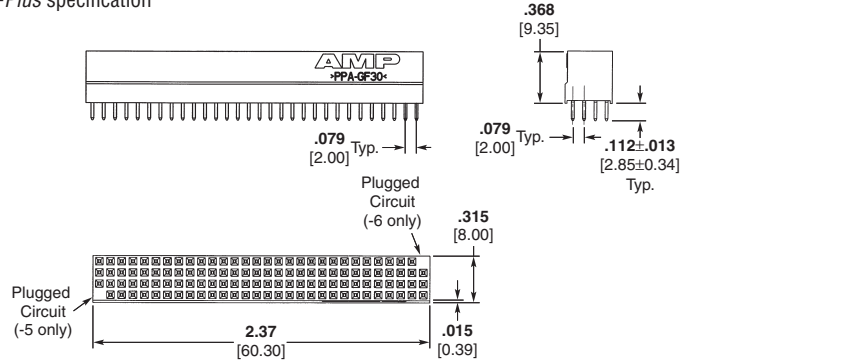

Recommended PC Board Layout for 1375967-4

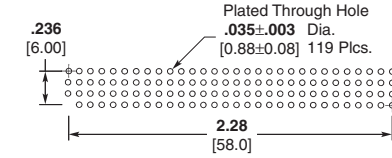

Recommended PC Board Layout for 1375967-5

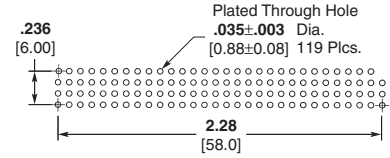

Recommended PC Board Layout for 1375967-6

Non-Stackthrough, 2 Standoffs

Part No. 1375965-4 (unkeyed)

Part No. 1375965-5 (keyed-A1)

per PC/104-Plus specification

Part No. 1375965-6 (keyed-D30)

per PC/104-Plus specification

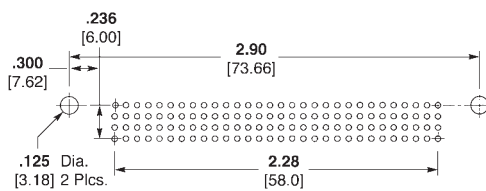
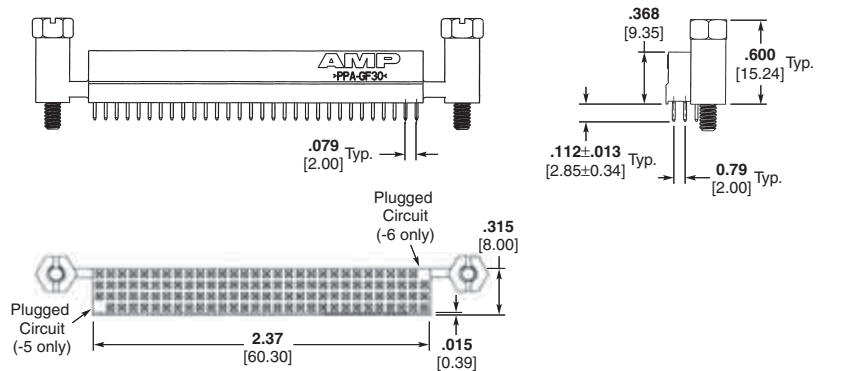

Recommended PC Board Layout for 1375965-4

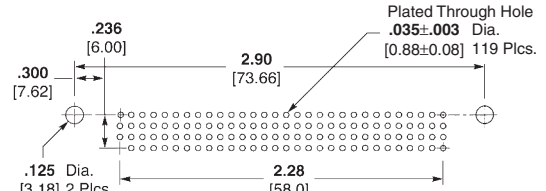

Recommended PC Board Layout for 1375965-5

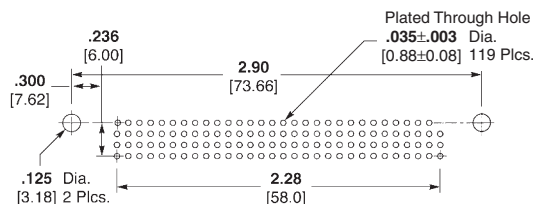

Recommended PC Board Layout for 1375965-6

Note: All part numbers are RoHS compliant.

Accessories

Shroud, PC/104-Plus
Part No. 1375801-1

Material — PBT, Black

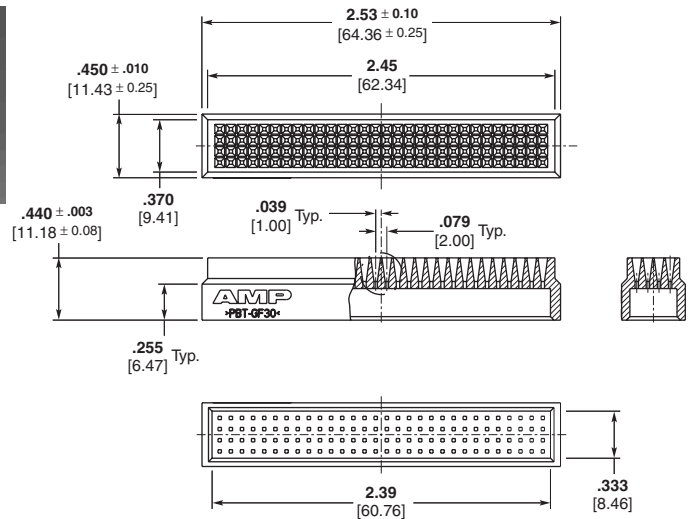
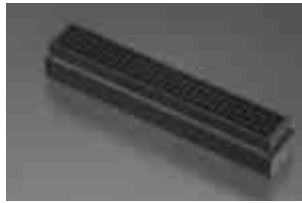

Organizer, PC/104
Part Number 1445251-1

Material — Polyester, PBT, Black

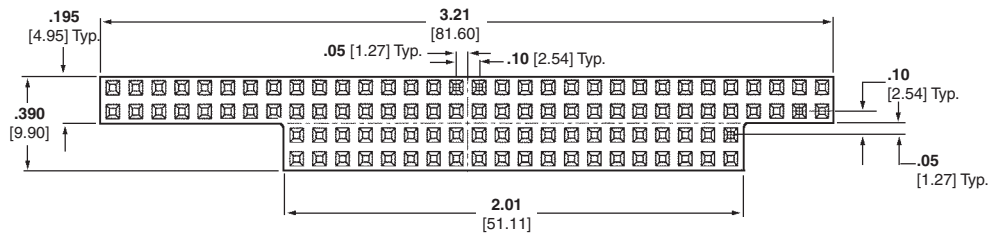

Kit Packaging Part Numbers

Part Number	Component Part Number		Style
	Connector Assembly	Organizer	
1445441-3	1375795-3	1445251-1	Keyed
1445441-4	1375795-4	1445251-1	Unkeyed
1445440-3	1375793-3	1445251-1	Keyed
1445440-4	1375793-4	1445251-1	Unkeyed
1445439-3	1375791-3	1445251-1	Keyed
1445439-4	1375791-4	1445251-1	Unkeyed

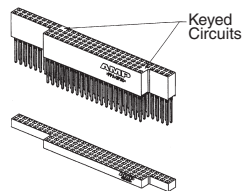

Part No. 1445441-3

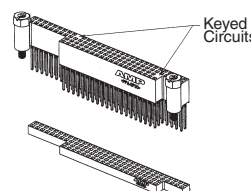

Part No. 1445440-3

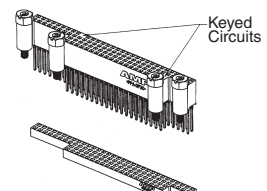

Part No. 1445439-3

Note: All part numbers are RoHS compliant.

AMPMODU 50/50 Grid Connector System

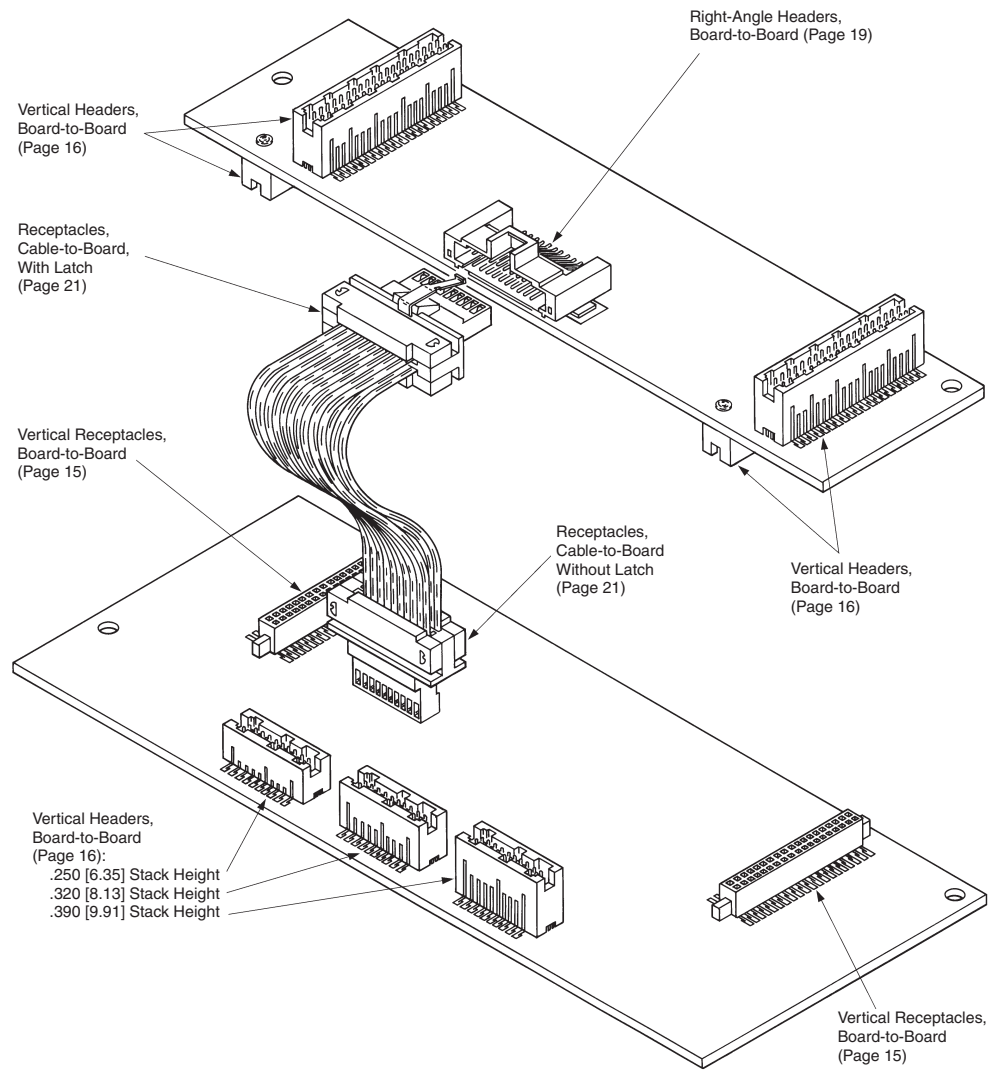



Produced under a Quality Management System certified to ISO 9001

A copy of the certificate is available upon request.



Product Facts

- Surface-mount products for parallel board-to-board applications, as well as right-angle board-to-board and cable-to-board applications
- High density .050 x .050 [1.27x1.27] centerline grid
- Three board-to-board stack heights: .250 [6.35], .320 [8.13] and .390 [9.91]
- Non-protrusive metallic holddowns
- Reliable dual beam receptacle contacts for redundant contact
- Duplex plated receptacle and post contacts; gold plated on mating areas, tin plated on tails
- Compatible with standard surface-mount processing (VPR and IR)
- Receptacle and header allow for drainage of processing fluids
- Tape and reel packaging available. Contact Tyco Electronics for details
- Polarized header and receptacle assemblies
- Sizes of 10, 20, 30, 40, 50, 60, 70, 80 and 100 positions
- Recognized under the Component Program of Underwriters Laboratories Inc., File No. E28476 
- Certified by Canadian Standards Association File No. LR7189 

Board-to-Board Vertical Receptacles and Headers

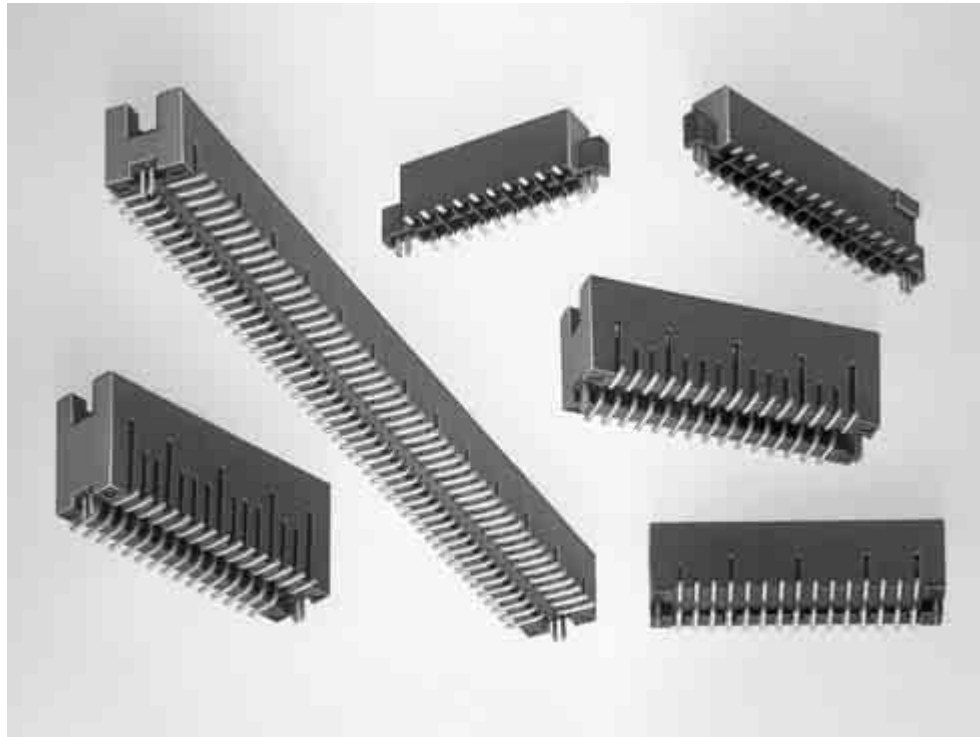

AMPMODU 50/50 Grid Vertical Headers and Receptacles are designed for parallel board-to-board stacking in high density applications.

Right-angle board-to-board and cable-to-board applications are also possible, since the vertical receptacles also mate with non-latching right-angle headers (page 19) and the vertical headers also mate with non-latching cable connectors.

Available are double row, vertical shrouded headers and receptacles in sizes ranging from 10 through 100 positions (in 10 position increments).

Parallel board-to-board stack heights of .250 [6.35], .320 [8.13] and .390 [9.91] are achievable by selection of the appropriate header. The receptacle is the same for all three stack height headers.

Non-protrusive metallic holddowns are designed for use in .062 [1.57] or thicker

PC boards and allow surface mounting to both sides of the board. In addition to providing retention during processing, the holddowns are soldered during reflow and therefore provide long-term strain relief for the solder joints.

AMPMODU 50/50 Grid Vertical Headers and Receptacles are designed to be compatible with standard surface-mount processes; IR (infrared) and VPR (vapor phase reflow). The surface-mount connectors have been designed so that dimensioning, tolerances, referenced datums, holddown characteristics

and packaging methods result in a system that is compatible with robotic assembly.

The headers and receptacles feature polarization to prevent misalignment.

Three Board Stack Heights

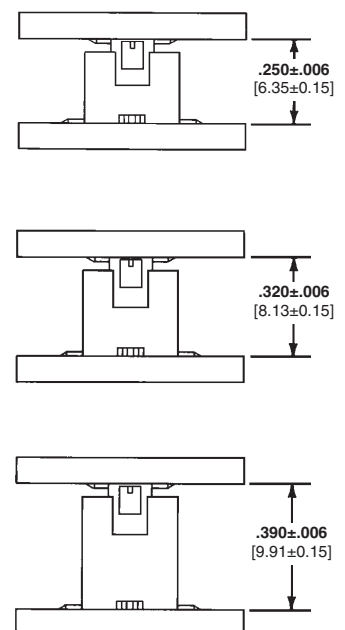

Non-Protrusive Metallic Holddowns

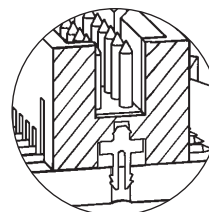

Board-to-Board Vertical Receptacles, Double Row, .050 x .050 [1.27 x 1.27] Centerline

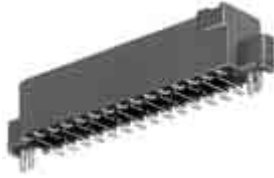

Material and Finish

Housing—Glass-filled thermoplastic, black, 94V-0 rated

Contacts—Copper alloy; duplex plated .000030 [0.00076] gold in mating area, .000150 [0.00381] tin on solder tail, with entire contact underplated .000050 [0.00127] nickel

Holddown—Copper alloy; plated .000150 [0.00381] tin over .000050 [0.00127] nickel

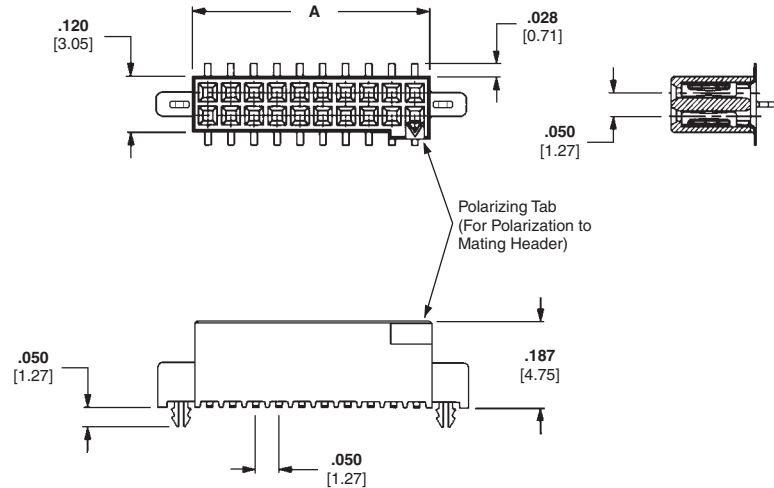

Related Product Data

Mating Headers — pages 16, 19

PC Board Layouts — page 17

Performance Specifications — page 24

Technical Documents — page 24

Product Specification 108-1332

Application Specification 114-7010

Packaging: Tube or Tape and Reel

No. of Pos.	Dimension A	Receptacle Part Numbers		
		Tube	Tape and Reel*	No Hold Down w/Vacuum Cover
10	.266 [6.75]	5-104652-1	5-147384-1	5-147413-1
20	.516 [13.11]	5-104652-2	5-147384-2	5-147413-3
30	.766 [19.46]	5-104652-3	5-147384-3	5-147413-4
40	1.016 [25.81]	5-104652-4	5-147384-4	—
50	1.266 [32.16]	5-104652-5	5-147384-5	5-147413-2
60	1.516 [38.51]	5-104652-6	5-147384-6	—
70	1.766 [44.86]	5-104652-7	5-147384-7	—
80	2.016 [51.21]	5-104652-8	5-147384-8	—
100	2.516 [63.91]	6-104652-0	5-147384-9	—

* Parts packaged in tape and reel have vacuum pick and place cover. See PC Board Layout on page 17.

Note: All part numbers are RoHS compliant.

**Board-to-Board Vertical Headers, Double Row, .050 x .050
[1.27 x 1.27] Centerline**



For .250 [6.35] Mated Height



For .320 [8.13] Mated Height



For .390 [9.91] Mated Height

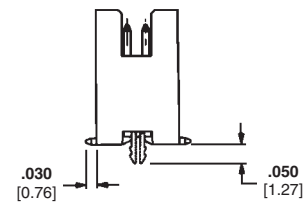
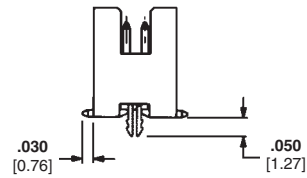
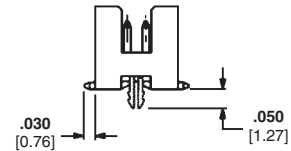
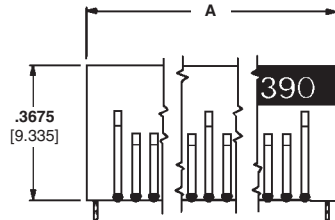
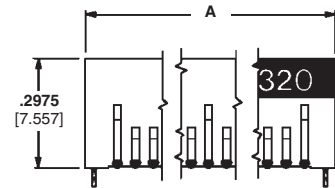
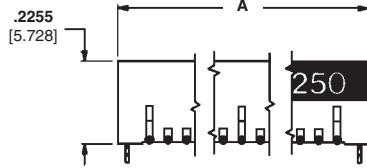
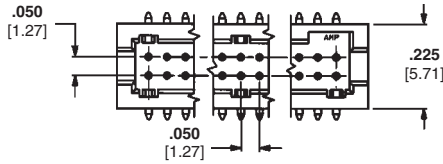

Material and Finish

Housing—Glass-filled thermoplastic, black, 94V-0 rated

Contacts—Copper alloy; duplex plated .000030 [0.00076] gold in mating area, .000150 [0.00381] tin on solder tail, with entire contact underplated .000050 [0.00127] nickel

Holddown—Copper alloy; plated .000150 [0.00381] tin over .000050 [0.00127] nickel

Related Product Data

Mating Receptacles — page 15, 21 (without latch only)

PC Board Layouts — page 17

Performance Specifications — page 24

Technical Documents — page 24

Product Specification 108-1332

Application Specification 114-7010

Packaging: Tube or Tape and Reel

No. of Pos.	Dimension A	Header Part Numbers								
		.250 [6.35] Mated Height			.320 [8.13] Mated Height		.390 [9.91] Mated Height			
		Tubes	Tape & Reel*		Tubes	Tape & Reel*	Tubes		Tape & Reel*	
		Hold Down	No Hold Down			Hold Down	No Hold Down			
10	.372 [9.44]	5-104655-1	5-147381-1	5-147121-1	5-104656-1	5-147382-1	5-104693-1	—	5-147383-1	
20	.622 [15.79]	5-104655-3	5-147381-2	5-147121-2	5-104656-2	5-147382-2	5-104693-2	—	5-147383-2	
30	.872 [22.14]	5-104655-4	5-147381-3	—	5-104656-3	5-147382-3	5-104693-3	—	5-147383-3	
40	1.122 [28.49]	5-104655-5	5-147381-4	—	5-104656-4	5-147382-4	5-104693-4	—	5-147383-4	
50	1.372 [34.84]	5-104655-6	5-147381-5	—	5-104656-5	5-147382-5	5-104693-5	—	5-147383-5	
60	1.622 [41.19]	5-104655-7	5-147381-6	—	5-104656-6	5-147382-6	5-104693-6	—	5-147383-6	
70	1.872 [47.54]	5-104655-8	5-147381-7	—	5-104656-7	5-147382-7	5-104693-7	—	5-147383-7	
80	2.122 [53.89]	5-104655-9	5-147381-8	—	5-104656-8	5-147382-8	5-104693-8	—	5-147383-8	
90	2.372 [60.24]	—	—	—	5-104656-9	—	5-104693-9	—	—	
100	2.622 [66.59]	6-104655-1	5-147381-9	—	6-104656-0	5-147382-9	6-104693-0	5-147503-1	5-147383-9	

*Parts packaged in tape and reel have vacuum pick and place cover. See PC Board Layout on page 17.

Note: All part numbers are RoHS compliant.

Vertical Headers,
Double Row
2

Recommended PC Board Layouts for Vertical Connectors

Headers

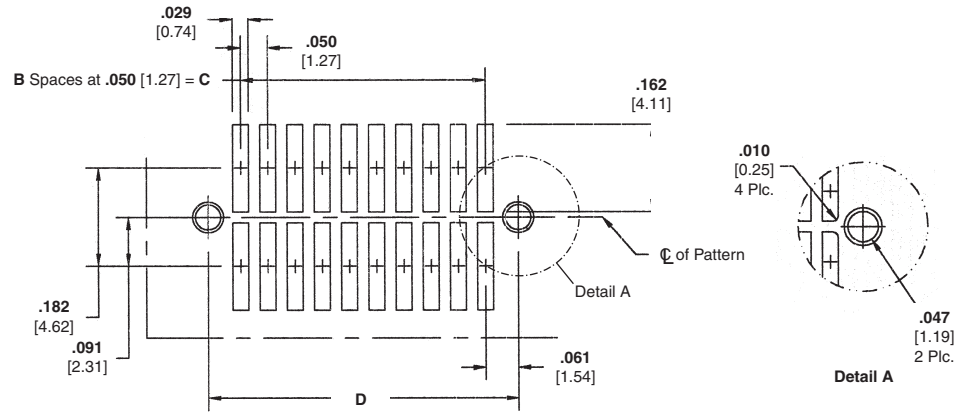

Receptacles

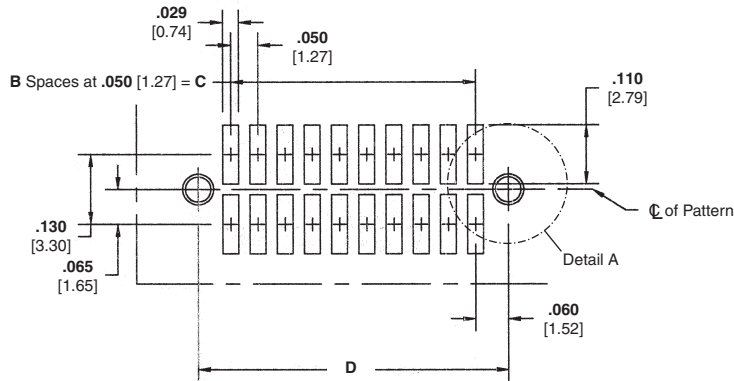

No. of Pos.	Receptacle Dimensions			Header Dimensions		
	B	C	D	B	C	D
10	4	.200 [5.08]	.320 [8.12]	4	.200 [5.08]	.322 [8.17]
20	9	.450 [11.43]	.570 [14.48]	9	.450 [11.43]	.572 [14.52]
30	14	.700 [17.78]	.820 [20.83]	14	.700 [17.78]	.822 [20.87]
40	19	.950 [24.13]	1.070 [27.19]	19	.950 [24.13]	1.072 [27.22]
50	24	1.200 [30.48]	1.320 [33.53]	24	1.200 [30.48]	1.322 [33.57]
60	29	1.450 [36.83]	1.570 [39.88]	29	1.450 [36.83]	1.572 [39.92]
70	34	1.700 [43.18]	1.820 [46.23]	34	1.700 [43.18]	1.822 [46.27]
80	39	1.950 [49.53]	2.070 [52.58]	39	1.950 [49.53]	2.072 [52.62]
90	44	2.200 [55.88]	2.320 [58.93]	44	2.200 [55.88]	2.322 [58.97]
100	49	2.450 [62.23]	2.570 [65.28]	49	2.450 [62.23]	2.572 [65.32]

Note: Refer to Tyco Electronics Customer Drawings for additional PC board layout information and dimensional tolerances.

Note: All part numbers are RoHS compliant.

Board-to-Board Right-Angle Headers

Product Facts

- Surface-mount products for right-angle board-to-board and cable-to-board applications
- Double-row, right-angle shrouded headers
- High density .050 x .050 [1.27 x 1.27] centerline grid
- Latching and non-latching versions available
- Non-protrusive metallic holddowns
- Metallic tabs, when soldered to PC board pad, provide added mechanical support
- Duplex plated post contacts; gold plated on mating area, tin plated on tails
- Compatible with standard surface-mount processing (VPR and IR)
- Standoffs on header housings allow for drainage of processing fluids
- All headers are polarized
- Sizes of 10, 20, 30, 40, 50, 60, 70, 80 and 100 positions
- Recognized under the Component Program of Underwriters Laboratories Inc., File No. E28476
- Certified by Canadian Standards Association File No. LR7189

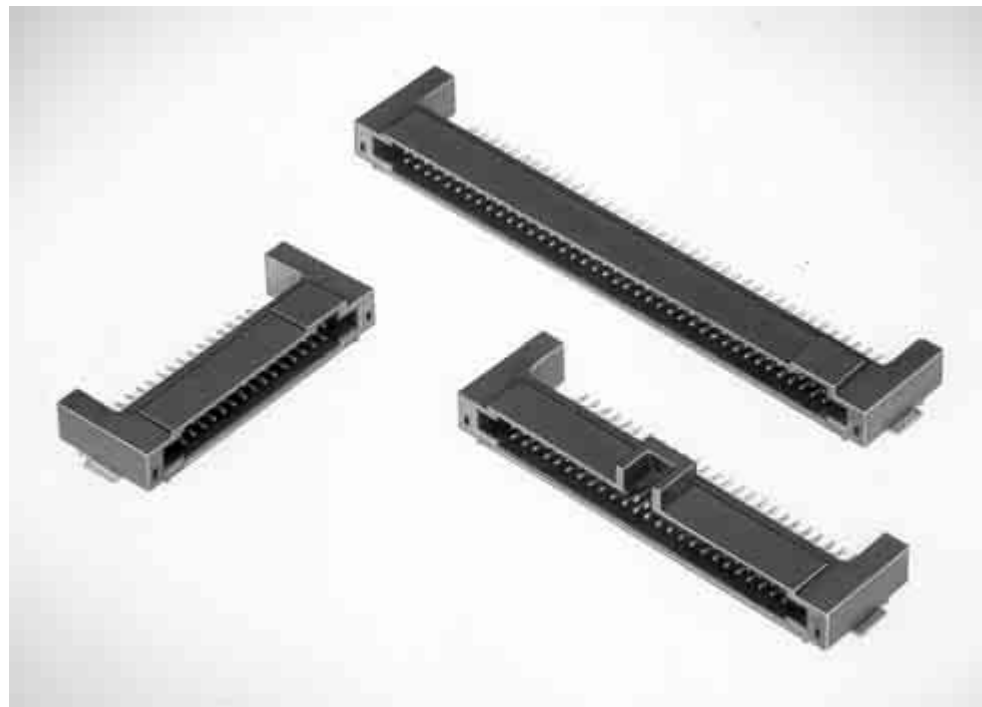

AMPMODU 50/50 Grid Right-Angle Headers will accommodate a variety of high density packaging applications; right-angle board-to-board applications when mated with vertical receptacles (page 15) and right-angle cable-to-board applications when mated with cable connectors (page 21). The small .050 x .050 [1.27 x 1.27] centerline contact spacing allows efficient use of the PC board area.

Mechanical support of the headers to the PC board is provided by non-protrusive metallic holddowns designed for .062 [1.57] or thicker PC boards. These holddowns are of the same

design as those used in the vertical headers (page 16) and receptacles (page 15). There are also metallic tabs that are soldered to the surfaces of the PC board pads for added support.

AMPMODU 50/50 Grid Right-Angle Headers are available in double-row, in either latching or non-latching versions, and in sizes ranging from 10 through 100 positions (in 10 position increments). The latching version provides positive retention when mated with the latching cable connector (page 21). All headers feature polarization to help prevent misalignment during mating.

Board-to-Board Right-Angle Headers, Double Row, .050 x .050 [1.27 x 1.27] Centerline

Non-Latching Header

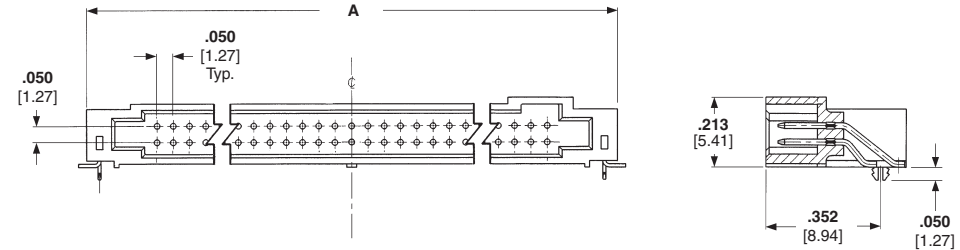

Latching Header

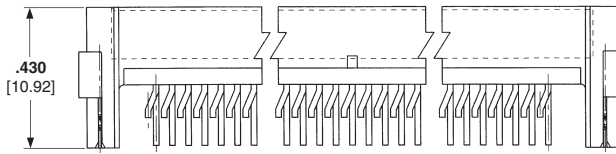
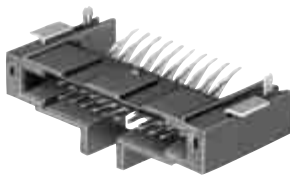

Material and Finish

Housing — Liquid crystal polymer, black, 94V-0 rated

Contacts — Copper alloy; duplex plated .000030 [0.00076] gold in mating area, .000150 [0.000381] tin on solder tail, with entire contact under-plated .000050 [0.00127] nickel

Holddown — Copper alloy; plated .0000150 [0.00381] tin over .000050 [0.00127] nickel

Related Product Data

Mating Receptacles — page 15, 21

Performance Specifications — page 24

Technical Documents — page 24

Product Specification 108-1443

Application Specification 114-7010

Packaging: Tube

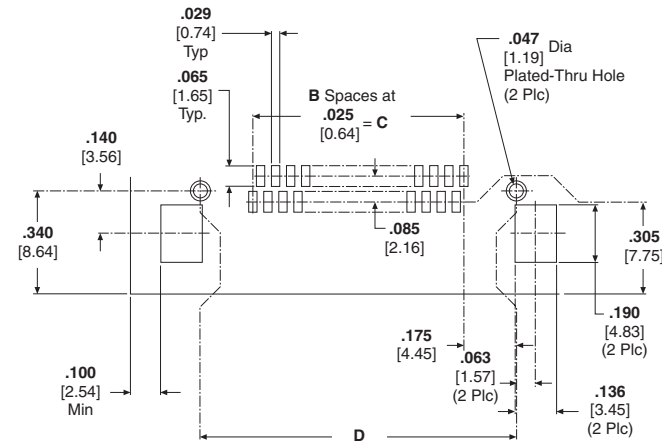

Recommended PC Board Layout



Note: Refer to Tyco Electronics Customer Drawings for additional PC board layout information and dimensional tolerances.

No. of Pos.	Dimensions				Header Part Numbers	
	A	B	C	D	Latching	Non-Latching
10	.630 [16.00]	9	.225 [5.72]	.550 [13.97]	5-104895-1	5-104894-1
20	.880 [22.35]	19	.475 [12.07]	.800 [20.32]	5-104895-2	5-104894-2
30	1.130 [28.70]	29	.725 [18.42]	1.050 [26.67]	5-104895-3	5-104894-3
40	1.380 [35.05]	39	.975 [24.77]	1.300 [33.02]	5-104895-4	5-104894-4
50	1.630 [41.40]	49	1.225 [31.12]	1.550 [39.37]	5-104895-5	5-104894-5
60	1.880 [47.75]	59	1.475 [37.47]	1.800 [45.72]	5-104895-6	5-104894-6
70	2.130 [54.10]	69	1.725 [43.82]	2.050 [52.07]	5-104895-7	5-104894-7
80	2.380 [60.45]	79	1.975 [50.17]	2.300 [58.42]	5-104895-8	5-104894-8
100	2.880 [73.15]	99	2.475 [62.87]	2.800 [71.12]	6-104895-0	6-104894-0

Note: All part numbers are RoHS compliant.

Cable-to-Board Connectors

Product Facts

- Double-row receptacle connectors provide cable-to-board connection capabilities for vertical headers (non-latching) and right-angle headers (latching and non-latching)
- IDC (Insulation Displacement Crimp) mass termination of solid or stranded round conductor .050 [1.27] centerline ribbon cable with PVC or polyethylene insulation
- Accommodates ribbon cable conductor sizes of 28 AWG [0.08-0.09 mm²] and 30 AWG [0.05 mm²] and insulation diameters up to .036 [0.91] maximum
- Reliable single beam receptacle contact design
- Duplex plated receptacle contacts; gold plated in mating area, tin in termination area
- Terminating covers (sold separately) provide both strain relief and protection to the termination area
- Sizes of 10, 20, 30, 40, 50, 60, 70, 80 and 100 positions
- Connectors available with or without metal latch
- Connectors without latches are polarized to help prevent mismatching
- Recognized under the Component Program of Underwriters Laboratories Inc.,  File No. E28476
- Certified by Canadian Standards Association  File No. LR7189

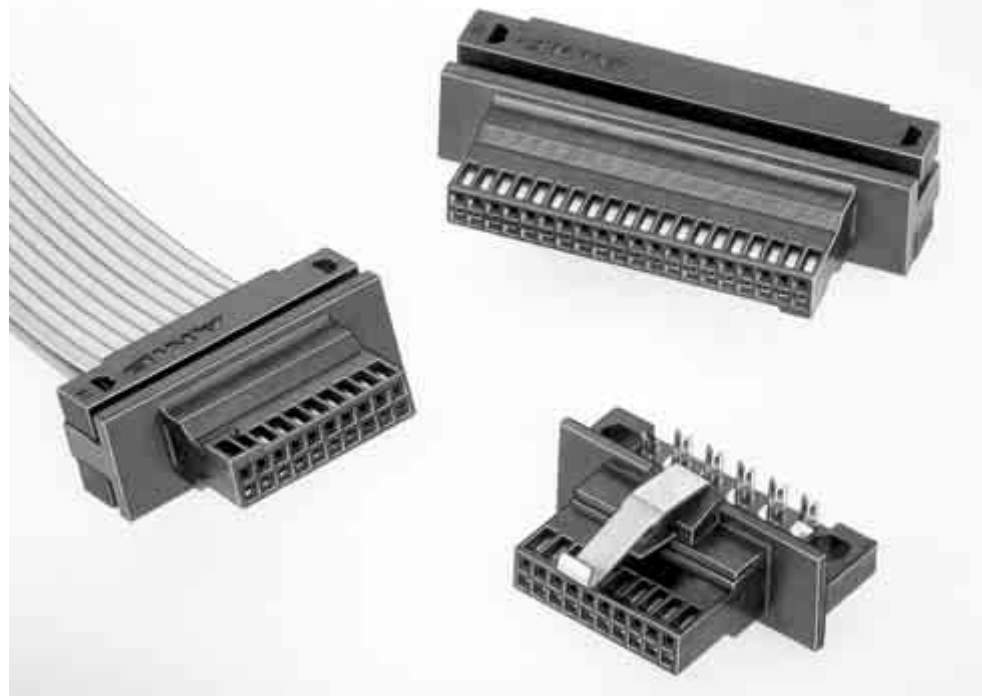

These double-row cable connectors, with a .050 x .050 [1.27 x 1.27] centerline contact spacing, provide cable-to-board connection capabilities for the AMPMODU 50/50 Grid Connector System. Cable connectors without a latch will mate with the vertical headers (page 16), while cable connectors with or without a latch can be used to mate with the right-angle headers (page 19).

The cable connectors feature reliable single-beam IDC (insulation displacement crimp) contacts which are duplex plated with .000030 [0.00076] gold. These contacts can be mass terminated to either solid or

stranded round conductor ribbon cable with conductor sizes of 28 AWG [0.08-0.09 mm²] and 30 AWG [0.05 mm²] and a maximum insulation diameter of .036 [0.91]. During termination, the terminating covers, which must be purchased separately, assist in guiding the wire into the IDC contacts, then provide strain relief when fully seated. Actual termination is accomplished with the Tyco Electronics manual tooling shown on page 23.

The latching version of the cable connector is equipped with a metal latch which provides positive retention of the receptacle cable connector when mated with a surface-

mounted right-angle header. The cable connector without a metal latch features polarization to help prevent mismatching. All connectors are available in sizes ranging from 10 through 100 positions (in 10 position increments).

Cable-to-Board Receptacle Connectors, Double Row, .050 x .050 [1.27 x 1.27] Centerline

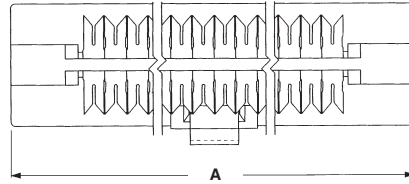
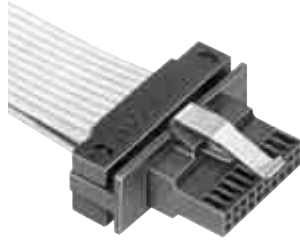

Material and Finish

Housing — Thermoplastic, black, 94V-0 rated

Latch — Stainless steel

Contacts — Phosphor bronze; duplex plated .000030 [0.00076] minimum gold in mating area, .000150 [0.00381] minimum tin on solder tail, with entire contact underplated .000050 [0.00127] minimum nickel

Related Product Data

Mating Headers — page 16, 19 (latching)

Terminating Covers (Must be Purchased Separately, 2 Required per Connector) — page 22

Termination Tooling — page 23

Performance Specifications — page 24

Technical Documents — page 24

Product Specification 108-1443

Application Specification
408-9817, 408-9909

Packaging: Tube

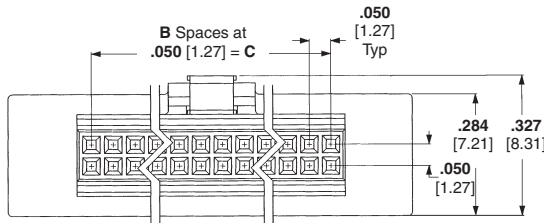
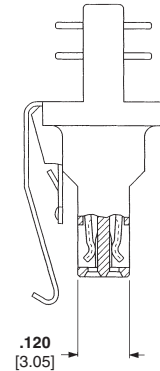
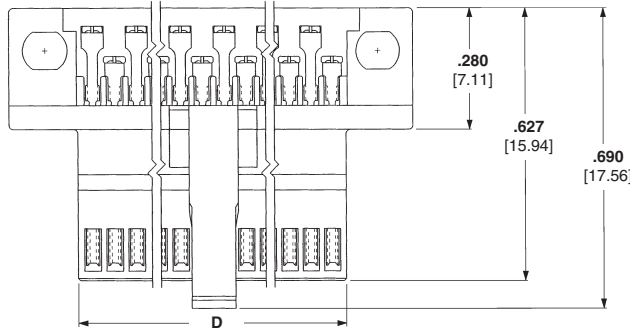

No. of Pos.	Dimensions				Receptacle Part Numbers	
	A	B	C	D	With Latch	Without Latch
10	.578 [14.68]	4	.200 [5.08]	.266 [6.76]	5-104892-1	5-104893-1
20	.828 [21.03]	9	.450 [11.43]	.516 [13.11]	5-104892-2	5-104893-2
30	1.078 [27.38]	14	.700 [17.78]	.766 [19.46]	5-104892-3	5-104893-3
40	1.328 [33.73]	19	.950 [24.13]	1.016 [25.81]	5-104892-4	5-104893-4
50	1.578 [40.08]	24	1.200 [30.48]	1.266 [32.16]	5-104892-5	5-104893-5
60	1.828 [46.43]	29	1.450 [36.83]	1.516 [38.51]	5-104892-6	5-104893-6
70	2.078 [52.78]	34	1.700 [43.18]	1.766 [44.86]	5-104892-7	5-104893-7
80	2.328 [59.13]	39	1.950 [49.53]	2.016 [51.21]	5-104892-8	5-104893-8
100	2.828 [71.83]	49	2.450 [62.23]	2.516 [63.91]	6-104892-0	6-104893-0

Note: All part numbers are RoHS compliant.

Terminating Covers for Cable Connectors



Cable Connector Terminating Cover, Double Row

2

Material

Glass-filled thermoplastic, black, 94V-0 rated

Related Product Data

Connectors used with Covers — page 21

Termination Tooling — page 23

Technical Documents — page 24

Product Specification 108-1443

Application Specification 408-9817, 408-9909

Packaging: Plastic bag

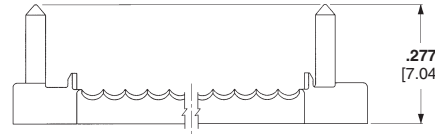
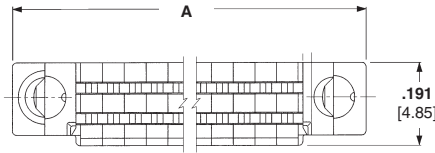

No. of Pos.	Dimension A	Terminator Cover Part Numbers
10	.565 [14.35]	104891-1
20	.815 [20.70]	104891-2
30	1.065 [27.05]	104891-3
40	1.315 [33.82]	104891-4
50	1.565 [39.75]	104891-5
60	1.815 [46.10]	104891-6
70	2.065 [52.45]	104891-7
80	2.315 [58.80]	104891-8
100	2.815 [71.50]	1-104891-0

Note: Terminating covers must be purchased separately, two are required for each cable connector.

Note: All part numbers are RoHS compliant.

Application Tooling for Cable Connectors

The Manual Miniature Application Frame Assembly 91295-1, equipped with a Cover Closing Kit 543518-1, is used for the IDC termination of ribbon cable to the cable connectors shown on page 21.

Prior to termination, the covers must be partially assembled onto a connector housing, the cable inserted between the covers and contacts and the covers preclosed by hand, clamping the cable in place.

In the Manual Miniature Application Frame Assembly, the covers are fully seated to complete the mass termination and provide strain relief for the completed connection.

For tooling information, call Technical Support Center **1-800-522-6752**.



Manual Miniature Application Frame Assembly 91295-1 with Cover Closing Kit 543518-1

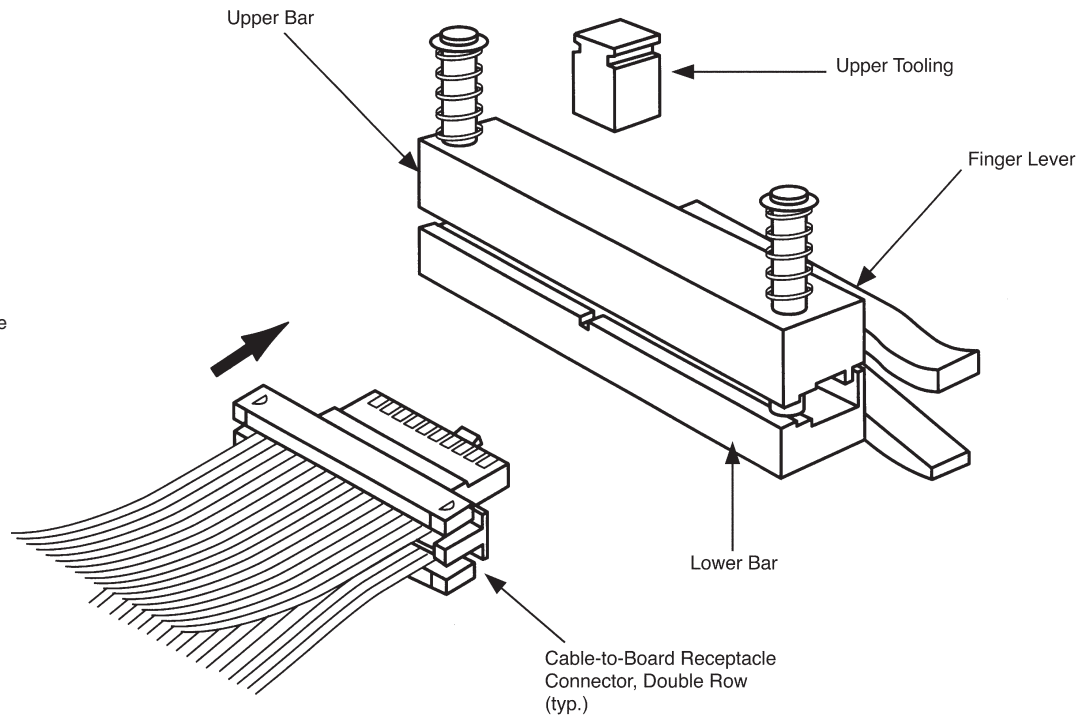

Note: Refer to Tyco Electronics Instruction Sheets 408-9817 (Frame Assembly 91295-1) and 408-9909 (Cover Closing Kit 543518-1) for complete termination/tooling information.

Note: All part numbers are RoHS compliant.

Performance Specifications

Board-to-Board Connectors, Vertical and Right-Angle

Mating Force: 6.4 oz (1.78 N) max. per contact
Unmating Force: 1.0 oz [0.28 N] min. per contact
Durability: Tested to 200 cycles min.
Current Rating: (30°C T rise): .5 ampere per contact
Operating Temperature Range: -65°C to +105°C
Termination Resistance: 16 milliohms max. (initial)
Insulation Resistance: 5000 megohms min. (initial)
Dielectric Withstanding Voltage: 300 VAC

Cable-to-Board Connectors

Mating Force: 6.4 oz (1.78 N) max. per contact
Unmating Force Without Latch: .5 oz [0.14 N] min. per contact
Durability: Tested to 200 cycles min.
Current Rating: (10°C T rise): .5 ampere per contact
Operating Temperature Range: -65°C to +105°C
Termination Resistance: 25 milliohms max. (initial and final)
Insulation Resistance: 5000 megohms min. (initial)
Dielectric Withstanding Voltage: 300 VAC

Technical Documents

Various technical documents are available for your use:

Product Specifications describe technical performance characteristics and verification tests. They are intended for the Design, Component and Quality Engineer.

108-1332	AMPMODU 50/50 Grid Vertical Board-to-Board Connectors
108-1443	AMPMODU 50/50 Grid Right-Angle Board-to-Board and Cable Connectors

Application Specifications describe requirements for using the product in its intended application and/or crimping information. They are intended for the Packaging and Design Engineer and the Machine Setup Person.

114-7010	AMPMODU 50/50 Grid Connector System
----------	-------------------------------------

Instruction Sheets provide instructions for assembling or applying the product. They are intended for the Manufacturing Assembler or Operator.

408-9817	Manual Miniature Application Frame Assembly 91295-1
408-9909	Cover Closing Kit 543518-1

Note: All part numbers are RoHS compliant.