

1-640250-0 ✓ ACTIVE



SL-156

TE Internal #: 1-640250-0

10 Position, Receptacle, Housing, Crimp, Wire-to-Board, UL 94V-0, 3.96 mm [.156 in] Centerline, 1 Row, 250 VAC, Wire & Cable, Power & Signal, SL-156

[View on TE.com >](#)

Connectors > Rectangular Connectors > Standard Rectangular Connectors > Receptacle Housing: Wire-to-Board, with Mating Alignment, SL156



Connector Product Type: **Housing**

Connector & Housing Type: **Receptacle**

Mating Retention Type: **Locking Ramp**

Connector System: **Wire-to-Board**

Contact Retention Within Housing: **Without**

[All Receptacle Housing: Wire-to-Board, with Mating Alignment, SL156 \(107\)](#)

Features

Product Type Features

Connector Product Type	Housing
Connector & Housing Type	Receptacle
Connector System	Wire-to-Board
Sealable	No
Connector & Contact Terminates To	Wire & Cable

Configuration Features

Number of Positions	10
Number of Rows	1

Electrical Characteristics

Operating Voltage	250 VAC
-------------------	---------

Body Features

Primary Product Color	Natural
-----------------------	---------



Contact Features

Contact Retention Within Housing	Without
Contact Type	Socket
Contact Current Rating (Max)	6.5 A

Termination Features

Termination Method to Wire & Cable	Crimp
------------------------------------	-------

Mechanical Attachment

Strain Relief	Without
Panel Mount Feature	Without
Mating Retention Type	Locking Ramp
Mating Retention	With
Connector Mounting Type	Cable Mount (Free-Hanging)

Housing Features

Housing Entry Configuration	Left End Open
Centerline (Pitch)	3.96 mm [.156 in]
Housing Material	Nylon GF

Dimensions

	1.558 in
Connector Height	6.35 mm
Wire Size	.0509 – .823 mm ²

Usage Conditions

Operating Temperature Range	-55 – 105 °C [-67 – 221 °F]
-----------------------------	-----------------------------

Operation/Application

Circuit Application	Power & Signal
---------------------	----------------

Industry Standards

Compatible With Agency/Standards Products	CSA, UL
UL Flammability Rating	UL 94V-0

Packaging Features

Packaging Quantity	1
Packaging Method	Package

Product Compliance







[For compliance documentation, visit the product page on TE.com>](#)

EU RoHS Directive 2011/65/EU	Compliant
EU ELV Directive 2000/53/EC	Compliant
China RoHS 2 Directive MIIT Order No 32, 2016	No Restricted Materials Above Threshold
EU REACH Regulation (EC) No. 1907/2006	Current ECHA Candidate List: JUNE 2025 (250) Candidate List Declared Against: JUNE 2025 (250) Does not contain REACH SVHC
Halogen Content	Low Halogen - Br, Cl, F < 900 ppm per homogenous material. Also BFR/CFR/PVC Free
Solder Process Capability	Not applicable for solder process capability

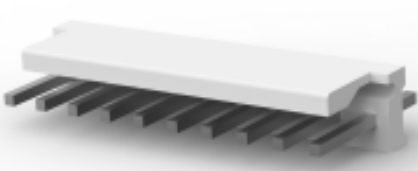
Product Compliance Disclaimer

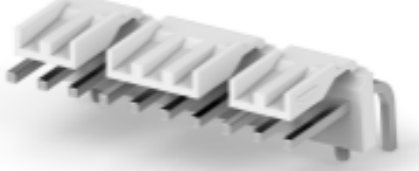
This information is provided based on reasonable inquiry of our suppliers and represents our current actual knowledge based on the information they provided. This information is subject to change. The part numbers that TE has identified as EU RoHS compliant have a maximum concentration of 0.1% by weight in homogenous materials for lead, hexavalent chromium, mercury, PBB, PBDE, DBP, BBP, DEHP, DIBP, and 0.01% for cadmium, or qualify for an exemption to these limits as defined in the Annexes of Directive 2011/65/EU (RoHS2). Finished electrical and electronic equipment products will be CE marked as required by Directive 2011/65/EU. Components may not be CE marked. Additionally, the part numbers that TE has identified as EU ELV compliant have a maximum concentration of 0.1% by weight in homogenous materials for lead, hexavalent chromium, and mercury, and 0.01% for cadmium, or qualify for an exemption to these limits as defined in the Annexes of Directive 2000/53/EC (ELV). Regarding the REACH Regulation, the information TE provides on SVHC in articles for this part number is based on the latest European Chemicals Agency (ECHA) 'Guidance on requirements for substances in articles' posted at this URL: <https://echa.europa.eu/guidance-documents/guidance-on-reach>

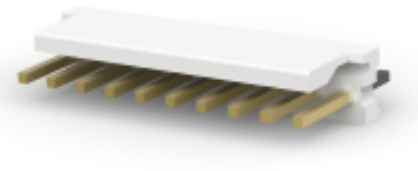
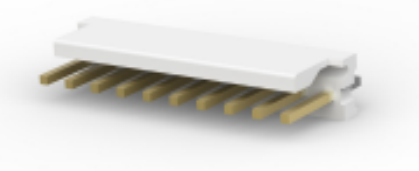
Compatible Parts

 <p>TE Part # 1-644752-0 10P MTA156 HDR ASSY SQ STR F/L</p>	 <p>TE Part # 1-640551-0 10P MTA156 COVER</p>	 <p>TE Part # 4-644617-0 10P MTA156 HDR ASY PO RA FB LF</p>	 <p>TE Part # 4-641202-0 10P MTA156 HDR ASSY PL 30AU LF</p>
 <p>TE Part # 4-644615-0 10P MTA156 POL LOCK ASSY LF</p>	 <p>TE Part # 4-644766-0 10P MTA156 HDR ASSY STR SQ LF</p>	 <p>TE Part # 4-641119-0 10P MTA156 HDR ASSY FL/ST LF</p>	 <p>TE Part # 1-1744516-0 10P MTA156 HDR PO GW LF</p>



Also in the Series | **SL-156**

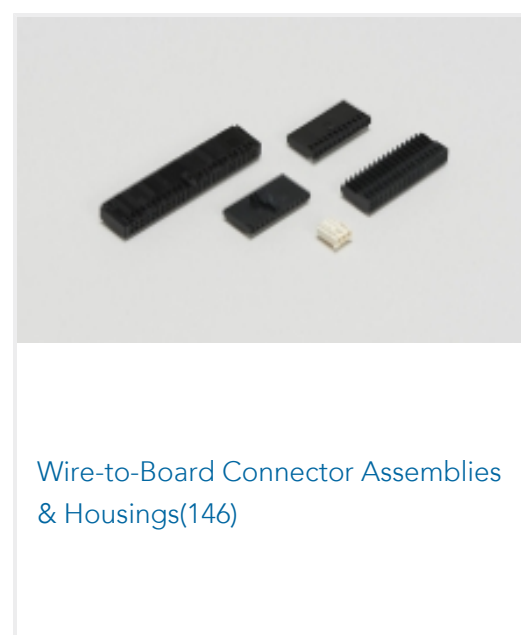
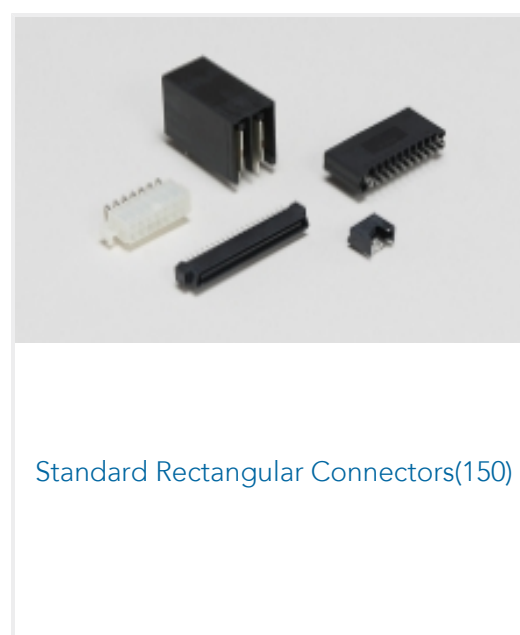
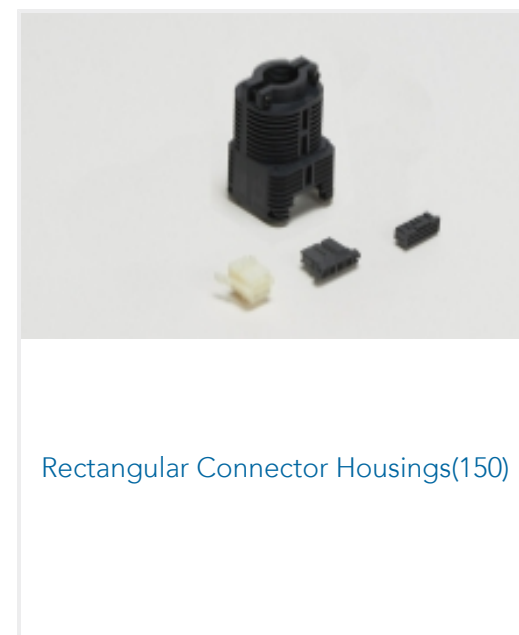
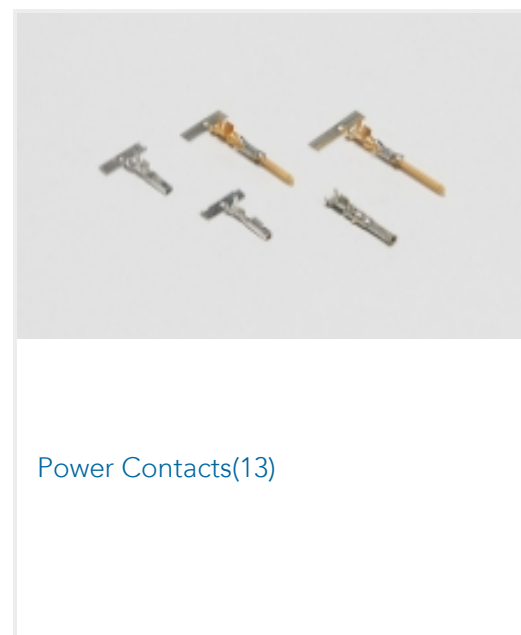
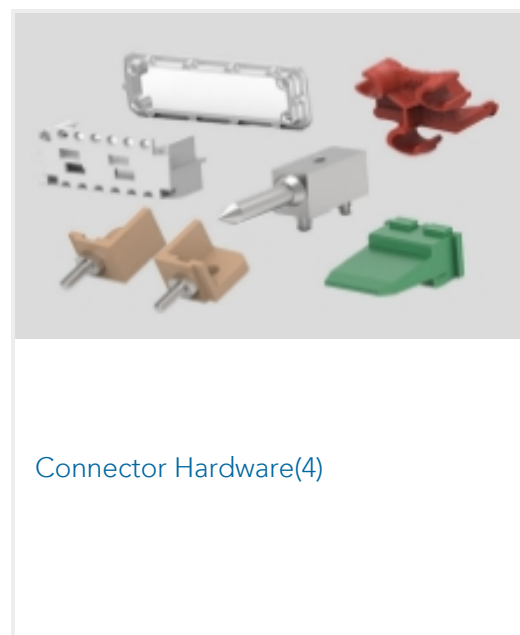
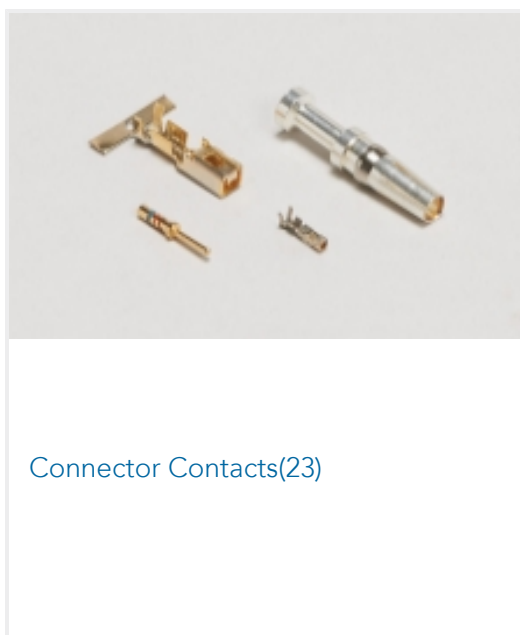

Customers Also Bought



TE Part #52409-1
PIDG SP SPD 22-16COM22-18MIL 6



TE Part #5-103949-1
8X2 MTE SHRD PIN SR LTCH .100



TE Part #5-103958-3
5X4 MTE RCPT SR LATCH .100CL

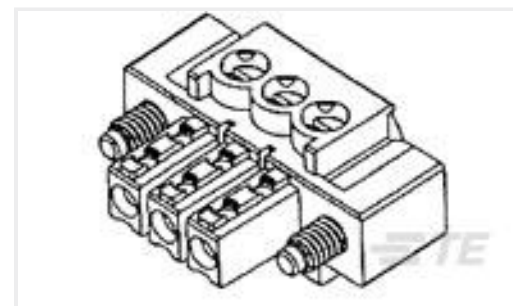

TE Part #284511-5
5 POS TERMI-BLOK PLUG C. VITI



TE Part #1-350373-9
06P STR/REL HNGD



TE Part #CAT-103156-WBHSM
Receptacle Housing: Wire-to-Board,
with Mating Alignment, SL156

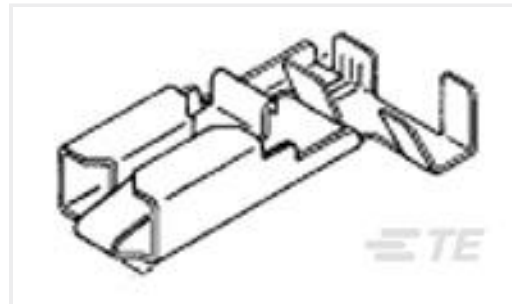

TE Part #926790-4
PL 250 FLAG REC 1-2.5 MM2 PTP
CUZN30 F53

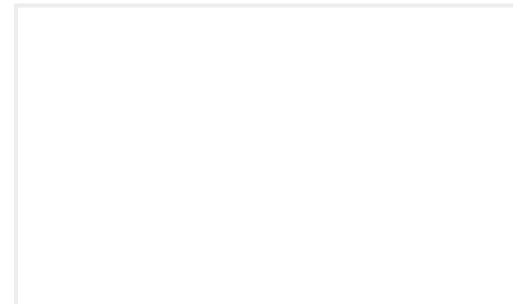

TE Part #7-1393111-8
KU-90323=KU



TE Part #4-2027513-2
KU-90388 =RELAY 1A,5A,AG,
BRACKET MOUNT

Documents

Product Drawings

[10P SL156 HSG W/LCK RAMP NATL](#)

English

CAD Files

[3D PDF](#)

3D

Customer View Model

[ENG_CVM_CVM_1-640250-0_AR_c-1-640250-0-ar.2d_dxf.zip](#)

English

Customer View Model

[ENG_CVM_CVM_1-640250-0_AR_c-1-640250-0-ar.3d_igs.zip](#)

English

Customer View Model

[ENG_CVM_CVM_1-640250-0_AR_c-1-640250-0-ar.3d_stp.zip](#)

English

By downloading the CAD file I accept and agree to the [Terms and Conditions](#) of use.

Product Specifications



Application Specification

English

Agency Approvals

UL Report

English