



MTA 156

TE Internal #: 1-640385-5

PCB Mount Header, Right Angle, Wire-to-Board, 15 Position, 3.96 mm [.156 in] Centerline, Unshrouded, Tin (Sn), Through Hole - Solder, Power, MTA 156

[View on TE.com >](#)

Connectors > PCB Connectors > PCB Headers & Receptacles

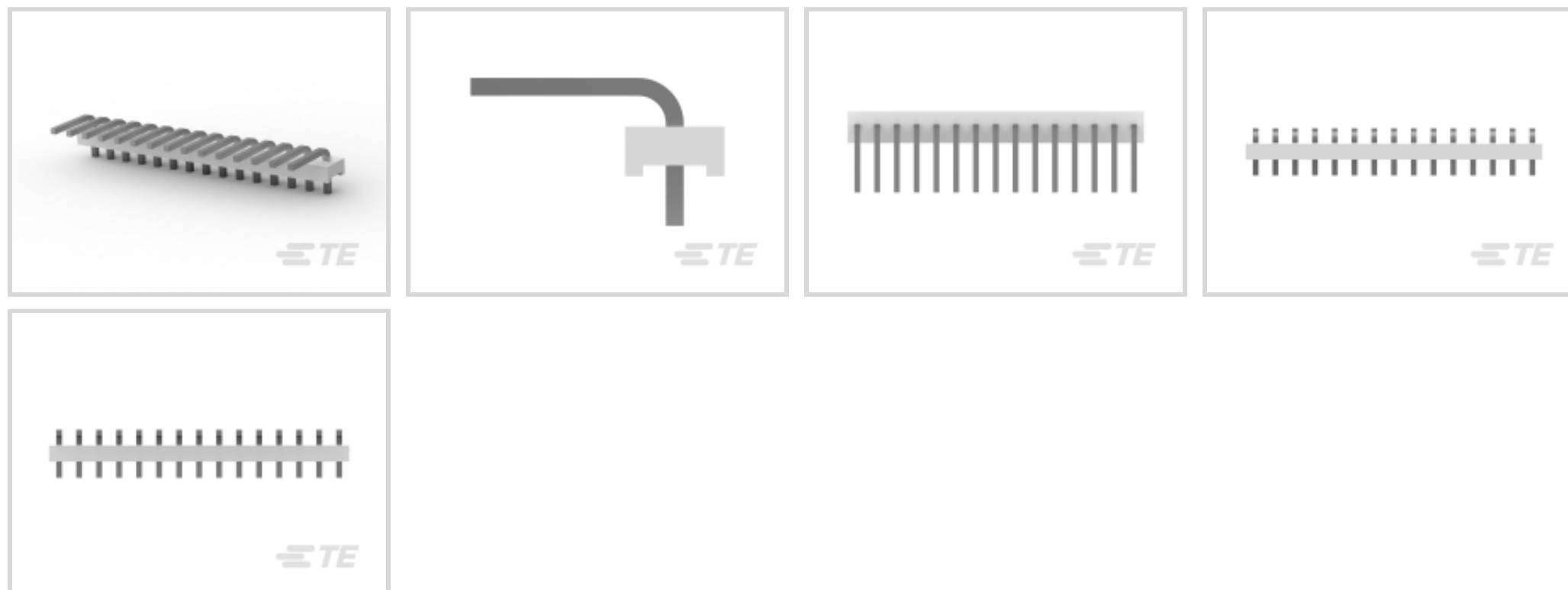

PCB Connector Type: **PCB Mount Header**

PCB Mount Orientation: **Right Angle**

Connector System: **Wire-to-Board**

Number of Positions: **15**

Centerline (Pitch): **3.96 mm [.156 in]**

Features

Product Type Features

Mixed & Hybrid Header	No
Connector Shape	Rectangular
PCB Connector Type	PCB Mount Header
Connector System	Wire-to-Board
Header Type	Unshrouded
Sealable	No
Connector & Contact Terminates To	Printed Circuit Board
Connector Product Type	Connector Assembly

Configuration Features

Number of Columns	15
Number of Loaded Positions	15
Connector Contact Load Condition	Fully Loaded
PCB Mount Orientation	Right Angle
Number of Positions	15



Number of Rows	1
----------------	---

Number of Power Positions	15
---------------------------	----

Electrical Characteristics

Operating Voltage	600 VAC
-------------------	---------

Body Features

Primary Product Color	Natural
-----------------------	---------

Contact Features

Contact Underplating Material	Nickel
-------------------------------	--------

Contact Underplating Material Thickness	1.27 μm [50 μin]
---	---

Contact Size	1.14mm
--------------	--------

Mating Square Post Dimension	1.14 mm[.045 in]
------------------------------	------------------

PCB Contact Termination Area Plating Material Thickness	2.54 μm [100 μin]
---	--

Contact Shape & Form	Square
----------------------	--------

Contact Layout	Inline
----------------	--------

Contact Mating Area Length	10.16 mm[.4 in]
----------------------------	-----------------

Contact Base Material	Copper Alloy
-----------------------	--------------

Contact Mating Area Plating Material	Tin (Sn)
--------------------------------------	----------

Contact Mating Area Plating Material Thickness	2.54 μm [100 μin]
--	--

Contact Type	Tab
--------------	-----

Contact Current Rating (Max)	14.24 A
------------------------------	---------

PCB Contact Termination Area Plating Material	Tin
---	-----

Termination Features

Termination Post & Tail Length	3.18 mm[.125 in]
--------------------------------	------------------

Square Termination Post & Tail Dimension	1.14 mm[.045 in]
--	------------------

Termination Method to PCB	Through Hole - Solder
---------------------------	-----------------------

Mechanical Attachment

Panel Mount Feature	Without
---------------------	---------

PCB Mount Alignment	Without
---------------------	---------

Mating Retention	Without
------------------	---------

PCB Mount Retention	Without
---------------------	---------

Connector Mounting Type	Board Mount
-------------------------	-------------

Mating Alignment	Without
------------------	---------



Housing Features

Mating Entry Location	Side
Centerline (Pitch)	3.96 mm [.156 in]
Housing Material	Thermoplastic Polyester GF

Dimensions

Connector Width	6.35 mm [.25 in]
PCB Thickness (Recommended)	1.57 mm [.062 in]
Connector Length	59.44 mm [2.34 in]

Usage Conditions

Operating Temperature (Max)	105 °C [221 °F]
Operating Temperature Range	-55 – 105 °C [-67 – 221 °F]

Operation/Application

Circuit Application	Power
---------------------	-------

Industry Standards

Compatible With Agency/Standards Products	CSA, UL
UL Rating	Recognized
Compatible With Approved Standards Products	UL E28476
Glow Wire Rating	Standard Part - Not Glow Wire
UL Flammability Rating	UL 94V-0

Packaging Features

Packaging Quantity	500
Packaging Method	Package

Product Compliance

[For compliance documentation, visit the product page on TE.com>](#)

EU RoHS Directive 2011/65/EU	Compliant
EU ELV Directive 2000/53/EC	Compliant
China RoHS 2 Directive MIIT Order No 32, 2016	No Restricted Materials Above Threshold
EU REACH Regulation (EC) No. 1907/2006	Current ECHA Candidate List: JUNE 2025 (250) Candidate List Declared Against: JUNE 2025 (250) Does not contain REACH SVHC
Halogen Content	Not Low Halogen - contains Br or Cl > 900

ppm.

Solder Process Capability

Wave solder capable to 265°C

Product Compliance Disclaimer

This information is provided based on reasonable inquiry of our suppliers and represents our current actual knowledge based on the information they provided. This information is subject to change. The part numbers that TE has identified as EU RoHS compliant have a maximum concentration of 0.1% by weight in homogenous materials for lead, hexavalent chromium, mercury, PBB, PBDE, DBP, BBP, DEHP, DIBP, and 0.01% for cadmium, or qualify for an exemption to these limits as defined in the Annexes of Directive 2011/65/EU (RoHS2). Finished electrical and electronic equipment products will be CE marked as required by Directive 2011/65/EU. Components may not be CE marked. Additionally, the part numbers that TE has identified as EU ELV compliant have a maximum concentration of 0.1% by weight in homogenous materials for lead, hexavalent chromium, and mercury, and 0.01% for cadmium, or qualify for an exemption to these limits as defined in the Annexes of Directive 2000/53/EC (ELV). Regarding the REACH Regulation, the information TE provides on SVHC in articles for this part number is based on the latest European Chemicals Agency (ECHA) 'Guidance on requirements for substances in articles' posted at this URL: <https://echa.europa.eu/guidance-documents/guidance-on-reach>

Compatible Parts



TE Part # 4-640601-5
15P MTA156 CONN ASSY 22AWG LF



TE Part # 1-640251-5
15P SL156 HSG W/O LCK RAMP



TE Part # CAT-103156-WBHSM
Receptacle Housing: Wire-to-Board, with Mating Alignment, SL156



TE Part # 1-770996-5
15P SL 156 HSG W/TABS W/O LR



TE Part # 4-640426-5
15P MTA156 CONN ASSY 18AWG ORA



TE Part # 4-640600-5
15P MTA156 CONN ASSY 20AWG LF



TE Part # 4-643817-5
15P MTA156 CONN ASSY 18AWG ORA



TE Part # 4-640428-5
15P MTA156 CONN ASSY 22AWG RED



TE Part # 4-640605-5
15P MTA156 CONN ASSY 20AWG LF



TE Part # 1-643067-5
15P MTA156 MOLDED COVER



TE Part # 4-640427-5
15P MTA156 CONN ASSY 20AWG YEL



TE Part # 4-643819-5
15P MTA156 CONN ASSY 22AWG LF



Also in the Series | MTA 156

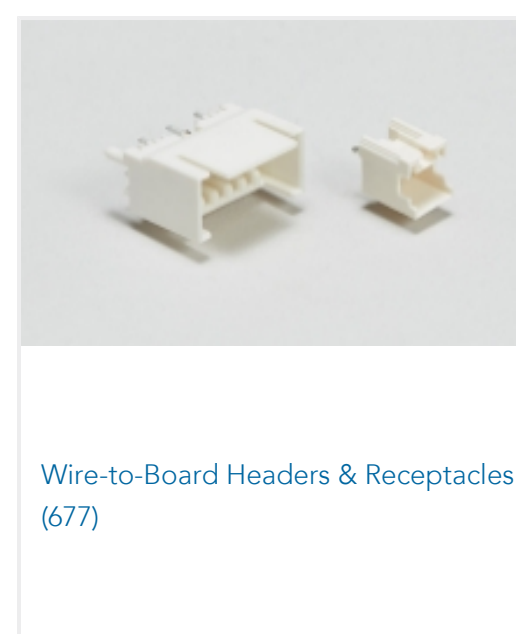
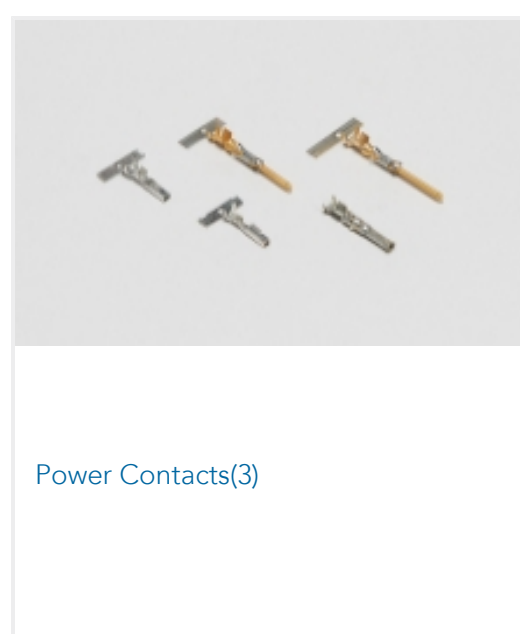
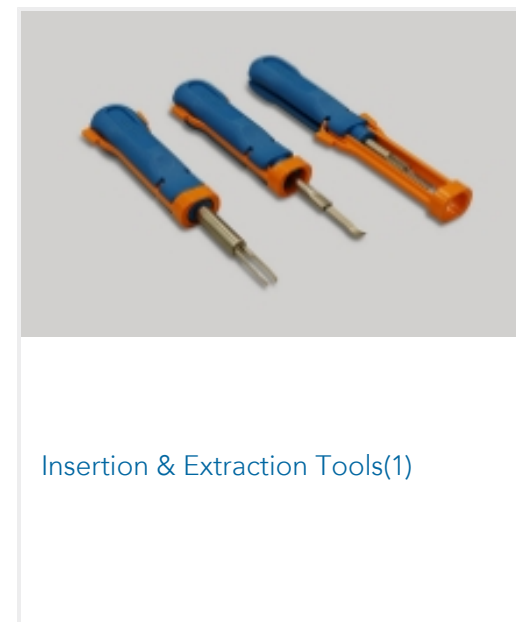
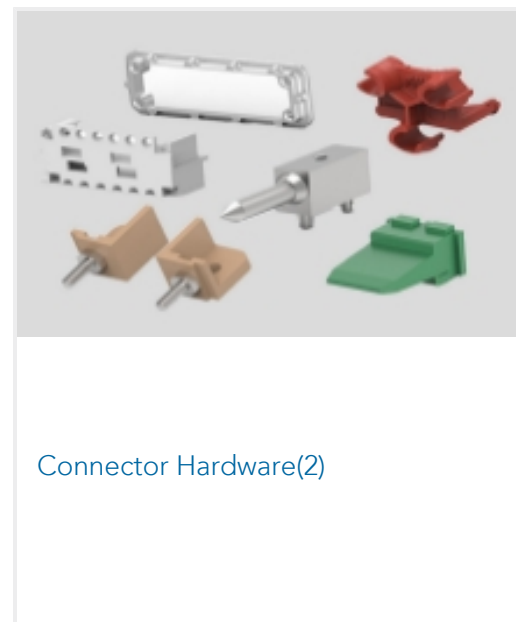
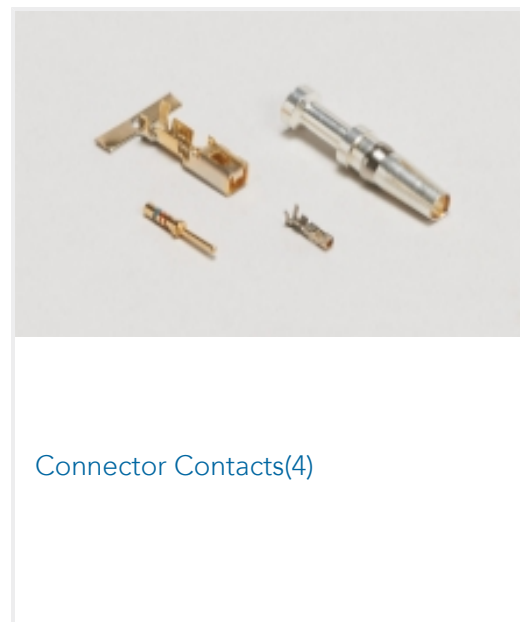

Customers Also Bought



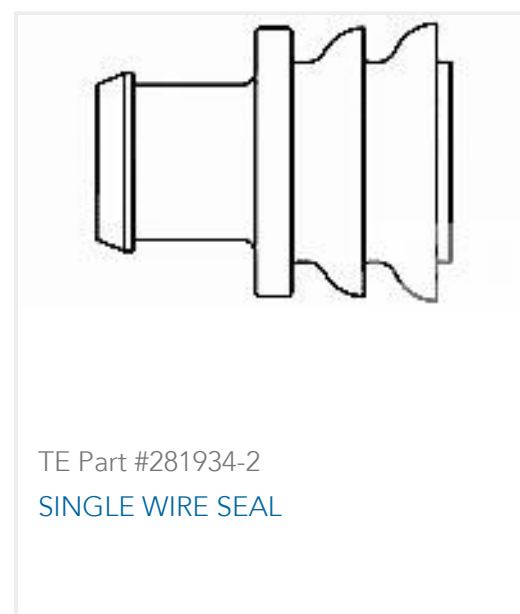

Documents

Product Drawings

[15P MTA156 HDR ASSY SQ R/A](#)

English

CAD Files

Customer View Model

[ENG_CVM_CVM_1-640385-5_AC.2d_dxf.zip](#)

English

[3D PDF](#)

3D

Customer View Model

[ENG_CVM_CVM_1-640385-5_AC.3d_igs.zip](#)

English

Customer View Model

[ENG_CVM_CVM_1-640385-5_AC.3d_stp.zip](#)

English

By downloading the CAD file I accept and agree to the [Terms and Conditions](#) of use.

Product Specifications

[Application Specification](#)

English

Agency Approvals

[Agency Approval Document](#)

English