

1-965640-6 ✓ ACTIVE



AMP | Junior Power Timer

TE Internal #: 1-965640-6

12 V, 6 Position, Automotive Housing for Female Terminals, Wire-to-Wire, 5 mm [.197 in] Centerline, Yellow, Wire & Cable, Power, Junior Power Timer

[View on TE.com >](#)

Automotive Parts > Automotive Connectors > Automotive Housings > Timer Connector Housing

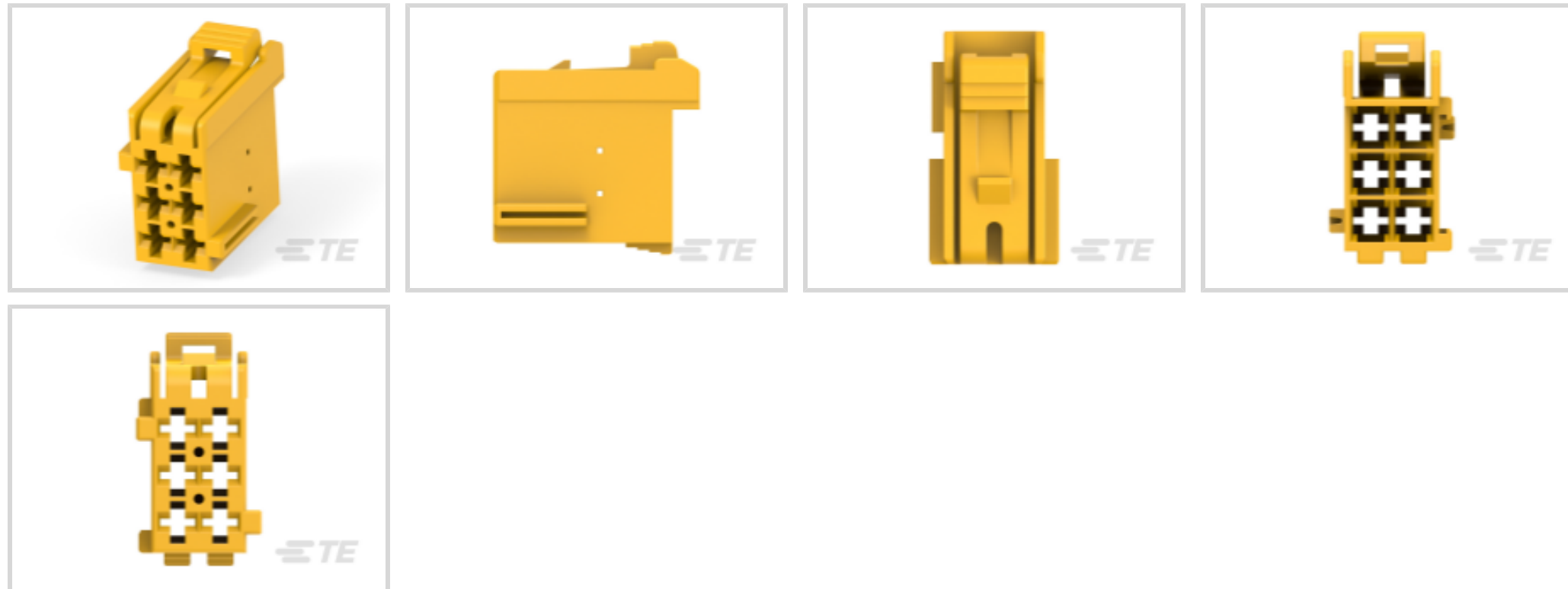

Nominal Voltage Architecture: 12 V

Connector & Housing Type: **Housing for Female Terminals**

Number of Positions: 6

Sealable: No

Operating Temperature Range: -30 – 130 °C [-22 – 266 °F]

[All Timer Connector Housing \(436\)](#)

Features

Product Type Features

Mixed & Hybrid Connector	No
Connector Shape	Rectangular
Connector & Housing Type	Housing for Female Terminals
Sealable	No
Primary Locking Feature	Locking Lance
Connector System	Wire-to-Wire
Connector & Contact Terminates To	Wire & Cable

Configuration Features

Number of Positions	6
Number of Rows	2

Electrical Characteristics

Nominal Voltage Architecture	12 V
------------------------------	------



Body Features

Cable Exit Angle	180 °
Primary Product Color	Yellow
Connector & Keying Code	A

Contact Features

Contact Size	2.8mm
Contact Type	Receptacle
Mating Tab Width	2.8 mm[.11 in]

Mechanical Attachment

Strain Relief	Without
Terminal Position Assurance	Yes
Mating Alignment Type	Keyed
Mating Alignment	With
Connector Mounting Type	Cable Mount (Free-Hanging)

Housing Features

Housing Material	PBT GF
Centerline (Pitch)	5 mm[.197 in]

Dimensions

Row-to-Row Spacing	5 mm[.196 in]
Product Length	11.2 mm[.441 in]
Connector Height	26.5 mm[1.043 in]

Usage Conditions

Operating Temperature Range	-30 – 130 °C[-22 – 266 °F]
Operating Temperature (Max)	100 °C[212 °F]

Operation/Application

Circuit Application	Power
---------------------	-------

Packaging Features

Packaging Method	Carton
------------------	--------

Other

Serviceable	No
Connector Position Assurance Capable	No



Product Compliance

[For compliance documentation, visit the product page on TE.com>](#)

EU RoHS Directive 2011/65/EU	Compliant
EU ELV Directive 2000/53/EC	Compliant
China RoHS 2 Directive MIIT Order No 32, 2016	有害物质含量符合标准要求 No Restricted Substance(s) Above Threshold
EU REACH Regulation (EC) No. 1907/2006	Current ECHA Candidate List: JUNE 2025 (250) Candidate List Declared Against: JUNE 2025 (250) Does not contain REACH SVHC
Halogen Content	Low Halogen - Br, Cl, F < 900 ppm per homogenous material. Also BFR/CFR/PVC Free
Solder Process Capability	Not applicable for solder process capability

Product Compliance Disclaimer

This information is provided based on reasonable inquiry of our suppliers and represents our current actual knowledge based on the information they provided. This information is subject to change. The part numbers that TE has identified as EU RoHS compliant have a maximum concentration of 0.1% by weight in homogenous materials for lead, hexavalent chromium, mercury, PBB, PBDE, DBP, BBP, DEHP, DIBP, and 0.01% for cadmium, or qualify for an exemption to these limits as defined in the Annexes of Directive 2011/65/EU (RoHS2). Finished electrical and electronic equipment products will be CE marked as required by Directive 2011/65/EU. Components may not be CE marked. Additionally, the part numbers that TE has identified as EU ELV compliant have a maximum concentration of 0.1% by weight in homogenous materials for lead, hexavalent chromium, and mercury, and 0.01% for cadmium, or qualify for an exemption to these limits as defined in the Annexes of Directive 2000/53/EC (ELV). Regarding the REACH Regulation, the information TE provides on SVHC in articles for this part number is based on the latest European Chemicals Agency (ECHA) 'Guidance on requirements for substances in articles' posted at this URL: <https://echa.europa.eu/guidance-documents/guidance-on-reach>

Compatible Parts



TE Part # CAT-LMPH9507
Low & Medium Power Header



TE Part # 1719810-1
JPT REC 2.8 Contact SRC Sn



TE Part # 1-965641-1
FLACH-STE-GEH2,8 6P



TE Part # CAT-T4827-T273
TIMER, RECEPTACLE AND TAB



Also in the Series | Junior Power Timer

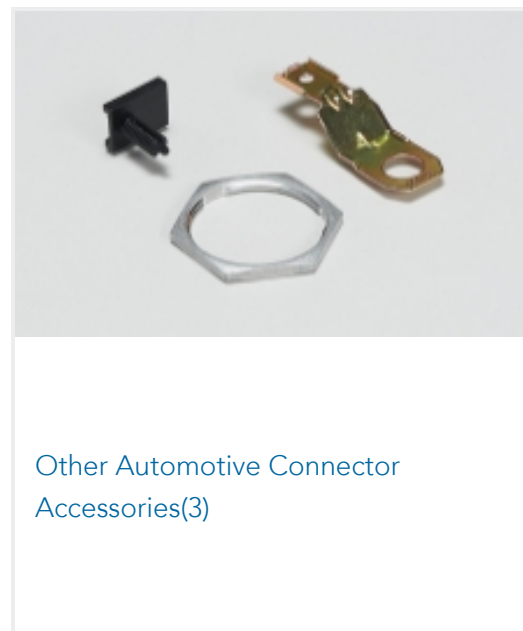
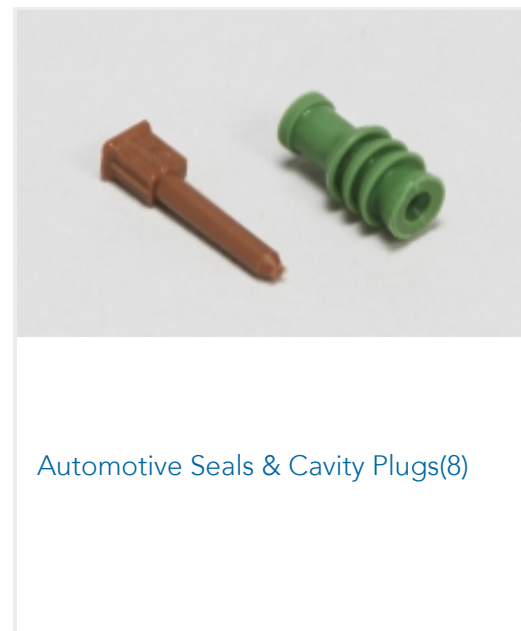
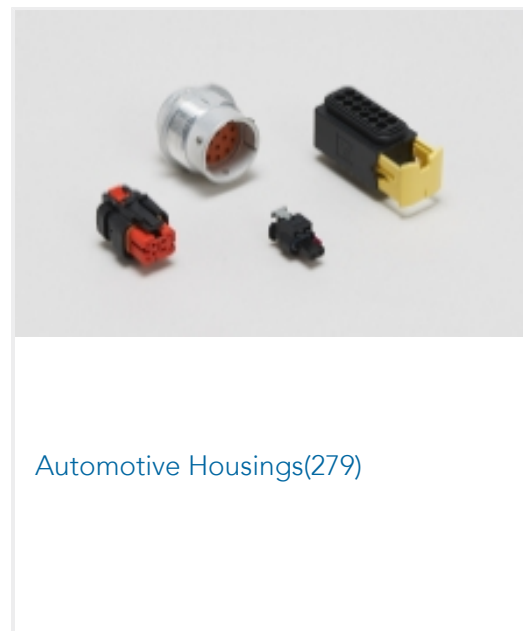
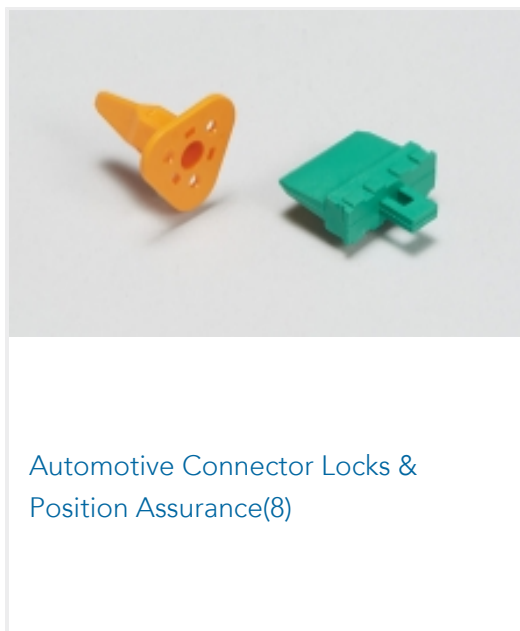

Customers Also Bought

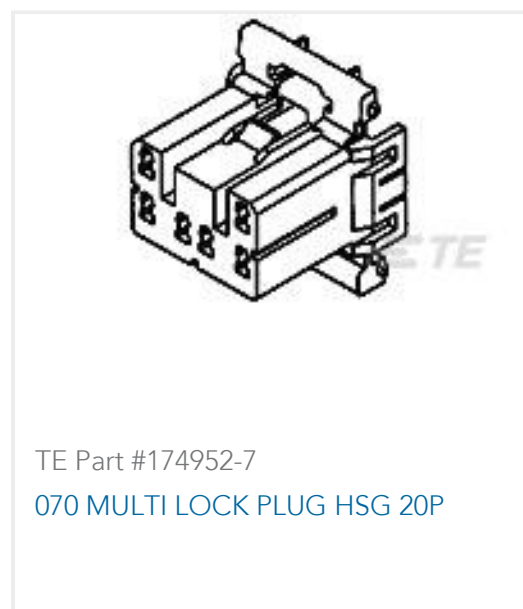
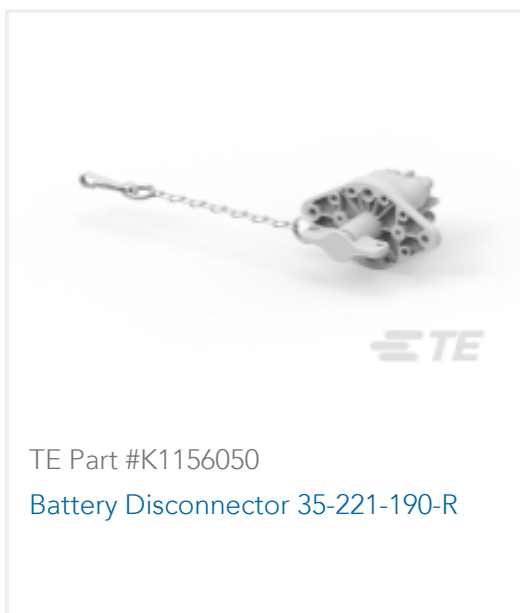



Documents

Product Drawings

JUN-POW-TIM GEH 6P

English

CAD Files

Customer View Model

[ENG_CVM_1-965640-6_D.3d_igs.zip](#)

English

Customer View Model

[ENG_CVM_1-965640-6_D.3d_stp.zip](#)

English

Customer View Model

[ENG_CVM_1-965640-6_D.2d_dxf.zip](#)

English

3D PDF

English

By downloading the CAD file I accept and agree to the [Terms and Conditions](#) of use.

Product Specifications

Product Specification

English

Product Specification

English