



AMPLIMITE

TE Internal #: 206798-2

15 Position D-Shaped Connector, Plug, Cable-to-Cable, Panel Mount, Shell Size 2, 2.77 mm [.109 in] Centerline, Wire & Cable, Signal

[View on TE.com >](#)

Connectors > D-Shaped Connectors



Number of Positions: **15**

Connector & Housing Type: **Plug**

Connector System: **Cable-to-Cable**

Connector Mounting Type: **Panel Mount**

Connector Shell Size: **2**

Features

Product Type Features

Connector & Housing Type	Plug
Connector System	Cable-to-Cable
Connector Shell Size	2
Sealable	No
Connector & Contact Terminates To	Wire & Cable

Configuration Features

Number of Positions	15
Power/Signal/Coax Combination	No

Body Features

Front Shell Material	Brass
Mating Retention Feature Material	Copper Alloy
D-Sub Connector Insert Arrangement	MS18274-1
Rear Shell Plating Material	Gold
Rear Shell Material	Brass
Front Shell Plating Material	Gold

Contact Features

Contact Type	Pin
Contact Size	Size 20



Contact Current Rating (Max)	7.5 A
------------------------------	-------

Contact Options	Order Separately
-----------------	------------------

Termination Features

Termination Method to Wire & Cable	Crimp
------------------------------------	-------

Mechanical Attachment

Mounting Hole Diameter	3.05 mm [.12 in]
------------------------	------------------

Connector Mounting Type	Panel Mount
-------------------------	-------------

Mating Alignment	Without
------------------	---------

Housing Features

Centerline (Pitch)	2.77 mm [.109 in]
--------------------	-------------------

Usage Conditions

Operating Temperature Range	-55 – 125 °C [-67 – 257 °F]
-----------------------------	-----------------------------

Operation/Application

Circuit Application	Signal
---------------------	--------

Packaging Features

Packaging Method	Package
------------------	---------

Product Compliance

[For compliance documentation, visit the product page on TE.com>](#)

EU RoHS Directive 2011/65/EU	Compliant
------------------------------	-----------

EU ELV Directive 2000/53/EC	Compliant
-----------------------------	-----------

China RoHS 2 Directive MIIT Order No 32, 2016	No Restricted Materials Above Threshold
---	---

EU REACH Regulation (EC) No. 1907/2006	Current ECHA Candidate List: JUNE 2025 (250) Candidate List Declared Against: JAN 2024 (240) Does not contain REACH SVHC
--	--

Halogen Content	Not Low Halogen - contains Br or Cl > 900 ppm.
-----------------	--

Solder Process Capability	Wave solder capable to 265°C
---------------------------	------------------------------

Product Compliance Disclaimer

This information is provided based on reasonable inquiry of our suppliers and represents our current actual knowledge based on the information they provided. This information is subject to change. The part numbers that TE has identified as EU RoHS compliant have a maximum concentration of 0.1% by weight in homogenous materials for lead, hexavalent chromium, mercury, PBB, PBDE, DBP, BBP, DEHP, DIBP, and 0.01% for cadmium, or qualify for an exemption to these

limits as defined in the Annexes of Directive 2011/65/EU (RoHS2). Finished electrical and electronic equipment products will be CE marked as required by Directive 2011/65/EU. Components may not be CE marked. Additionally, the part numbers that TE has identified as EU ELV compliant have a maximum concentration of 0.1% by weight in homogenous materials for lead, hexavalent chromium, and mercury, and 0.01% for cadmium, or qualify for an exemption to these limits as defined in the Annexes of Directive 2000/53/EC (ELV). Regarding the REACH Regulation, the information TE provides on SVHC in articles for this part number is based on the latest European Chemicals Agency (ECHA) 'Guidance on requirements for substances in articles' posted at this URL: <https://echa.europa.eu/guidance-documents/guidance-on-reach>

Compatible Parts

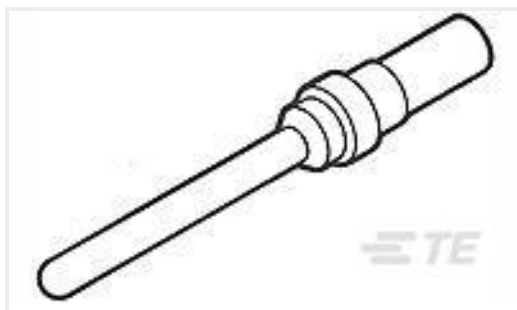

TE Part # 205089-4
HD 20 PIN CONTACT, NON-MAG



TE Part # 91067-2
INSERTION/EXTRACTION TOOL

Customers Also Bought

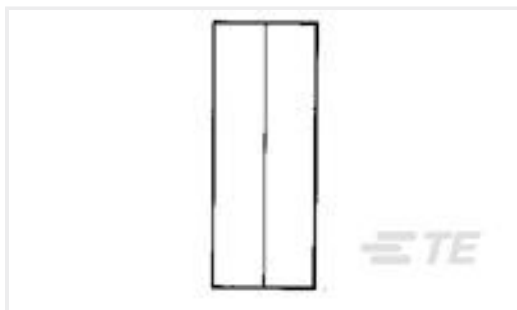

TE Part #34137-3
SOLIS, PARA 16-14 60/40 SN-PB

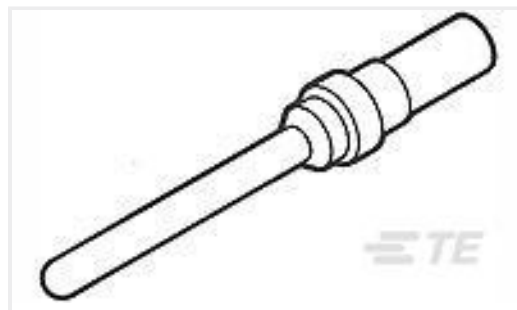

TE Part #205089-4
HD 20 PIN CONTACT, NON-MAG

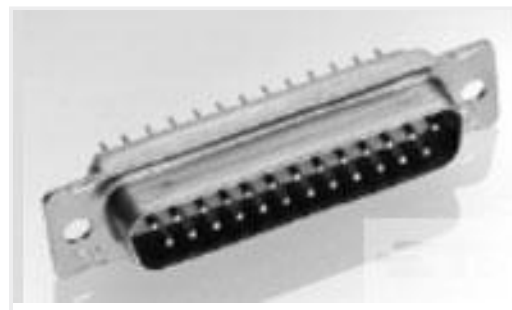

TE Part #206499-4
RECEPT ASSY, SZ 1, AMPLIMITE

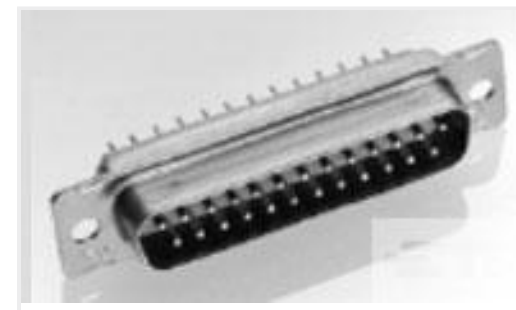

TE Part #206501-4
RECEPT ASSY, 26 POSN, AMPLIMITE



TE Part #206503-4
RECEPT ASSY, 62 POSN, AMPLIMITE

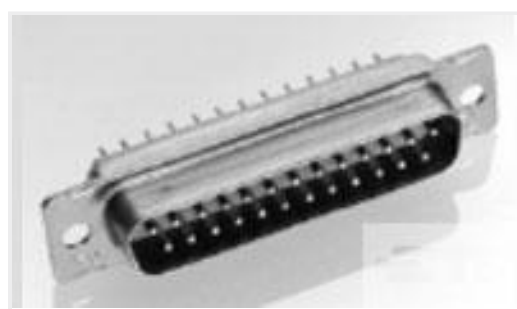

TE Part #206801-2
AMPLIMITE RECEPT ASY, 25 POS



TE Part #206803-2
AMPLIMITE RECEPT ASY, 37 POS,

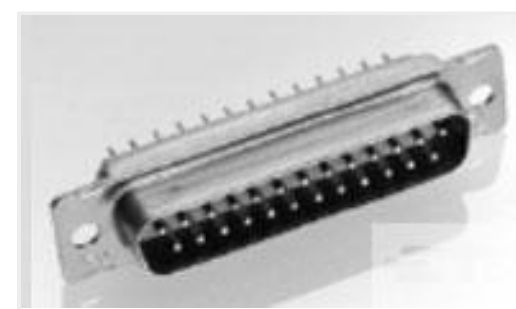

TE Part #207253-2
RECEPT ASSY, 9 POSN, AMPLIMITE

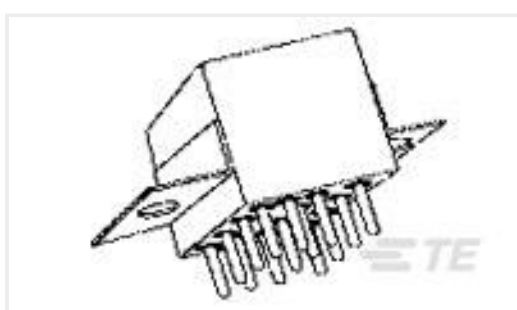

TE Part #7-1617760-9
FCB-405-0619M=M83536/6-019M



TE Part #34130-4
SOLIS, PARA 22-16 60/40 SN-PB

Documents



Product Drawings

[PLG ASSY,15 POS,AMPLIMITE](#)

English

CAD Files

[3D PDF](#)

3D

Customer View Model

[ENG_CVM_CVM_206798-2_AA.2d_dxf.zip](#)

English

Customer View Model

[ENG_CVM_CVM_206798-2_AA.3d_igs.zip](#)

English

Customer View Model

[ENG_CVM_CVM_206798-2_AA.3d_stp.zip](#)

English

By downloading the CAD file I accept and agree to the [Terms and Conditions](#) of use.