

3-640470-2 ✓ ACTIVE



MTA 100

TE Internal #: 3-640470-2

2 Position, Receptacle, Connector Assembly, Insulation

Displacement (IDC), Wire-to-Board, Tin (Sn), Normal, UL 94V-2,

MTA 100

[View on TE.com >](#)

Connectors > Rectangular Connectors > Standard Rectangular Connectors > MTA Receptacle: Nylon, Tin Plated, 2.54 mm

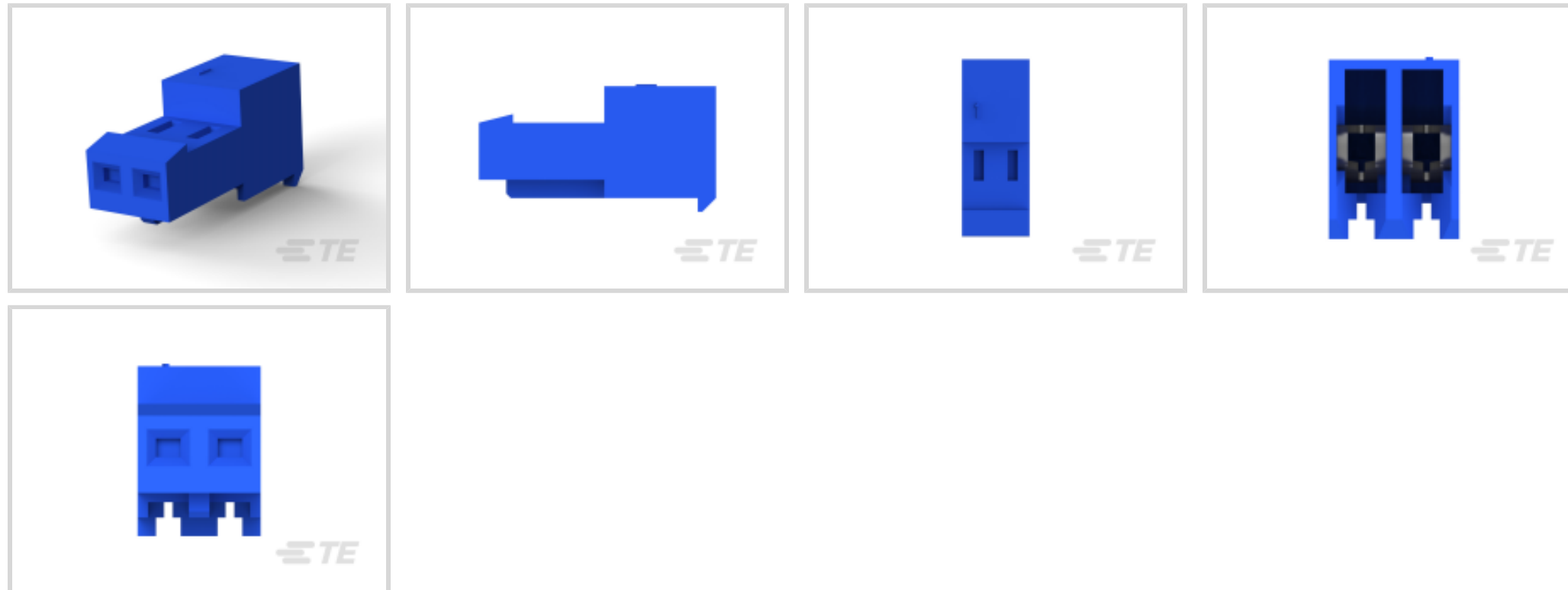

Connector Product Type: **Connector Assembly**

Mating Alignment: **Without**

Connector & Housing Type: **Receptacle**

Mating Retention Type: **Locking Ramp**

Connector System: **Wire-to-Board**

[All MTA Receptacle: Nylon, Tin Plated, 2.54 mm \(167\)](#)

Features

Product Type Features

Compatible With Discrete Wire Type	Stranded
Connector Product Type	Connector Assembly
Connector & Housing Type	Receptacle
Connector System	Wire-to-Board
Insertion Force Type	Normal
Sealable	No
Connector & Contact Terminates To	Wire & Cable

Configuration Features

Number of Cavities	2
Contacts Preloaded	Yes
Number of Positions	2
Number of Rows	1



Electrical Characteristics

Operating Voltage	250 VAC
-------------------	---------

Body Features

Primary Product Color	Blue
-----------------------	------

Contact Features

Contact Underplating Material	Nickel
Wire Contact Termination Area Plating Material	Tin
Contact Type	Receptacle
Contact Mating Area Plating Material	Tin (Sn)
Contact Retention Within Housing	With
Contact Current Rating (Max)	5 A

Termination Features

Termination Method to Wire & Cable	Insulation Displacement (IDC)
------------------------------------	-------------------------------

Mechanical Attachment

Contact Retention Type Within Housing	Locking Lance
Mating Alignment	Without
Mating Retention Type	Locking Ramp
Mating Retention	With
Connector Mounting Type	Cable Mount (Free-Hanging)

Housing Features

Housing Material	Nylon 6/6
Centerline (Pitch)	2.54 mm[.1 in]

Dimensions

Connector Width	6.99 mm[.275 in]
Connector Height	13.21 mm[.52 in]
Wire Size	26 AWG
Connector Length	5.08 mm[.2 in]

Usage Conditions

Operating Temperature Range	-55 – 105 °C[-67 – 221 °F]
-----------------------------	----------------------------

Operation/Application

Shielded	No
Circuit Application	Signal



Industry Standards

Compatible With Agency/Standards Products	CSA, UL
UL Rating	Recognized
Compatible With Approved Standards Products	UL E28476
CSA Rating	LR 7189
UL Flammability Rating	UL 94V-2

Packaging Features

Packaging Quantity	3700
Packaging Method	Box & Carton

Product Compliance

[For compliance documentation, visit the product page on TE.com>](#)

EU RoHS Directive 2011/65/EU	Compliant
EU ELV Directive 2000/53/EC	Compliant
China RoHS 2 Directive MIIT Order No 32, 2016	No Restricted Materials Above Threshold
EU REACH Regulation (EC) No. 1907/2006	Current ECHA Candidate List: JUNE 2025 (250) Candidate List Declared Against: JUNE 2025 (250) Does not contain REACH SVHC
Halogen Content	Low Halogen - Br, Cl, F < 900 ppm per homogenous material. Also BFR/CFR/PVC Free
Solder Process Capability	Not applicable for solder process capability

Product Compliance Disclaimer

This information is provided based on reasonable inquiry of our suppliers and represents our current actual knowledge based on the information they provided. This information is subject to change. The part numbers that TE has identified as EU RoHS compliant have a maximum concentration of 0.1% by weight in homogenous materials for lead, hexavalent chromium, mercury, PBB, PBDE, DBP, BBP, DEHP, DIBP, and 0.01% for cadmium, or qualify for an exemption to these limits as defined in the Annexes of Directive 2011/65/EU (RoHS2). Finished electrical and electronic equipment products will be CE marked as required by Directive 2011/65/EU. Components may not be CE marked. Additionally, the part numbers that TE has identified as EU ELV compliant have a maximum concentration of 0.1% by weight in homogenous materials for lead, hexavalent chromium, and mercury, and 0.01% for cadmium, or qualify for an exemption to these limits as defined in the Annexes of Directive 2000/53/EC (ELV). Regarding the REACH Regulation, the information TE provides on SVHC in articles for this part number is based on the latest European Chemicals Agency (ECHA) 'Guidance on requirements for substances in articles' posted at this URL: <https://echa.europa.eu/guidance-documents/guidance-on-reach>

Compatible Parts



TE Part # CAT-104MTA-PVSHH
Polyester Vertical PCB Header: 2.54 mm, Shrouded, MTA 100



TE Part # 3-647051-2
02P MTA100 HRD ASSYF/L HT LF



TE Part # 3-647106-2
02P MTA-100 HDR ASSY,SM,SN



TE Part # 640454-2
02P MTA100 HDR ASSY SQ STR POL



TE Part # CAT-104MTA-NTPMP
MTA Plug: Nylon, Tin Plated, 2.54 mm, with Mating Alignment



TE Part # 640550-2
02P MTA100 COVER



TE Part # CAT-104MTA-PRSMH
PCB Header, Right Angle, Polyester, 2.54 mm

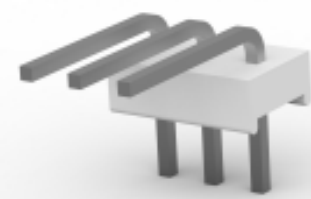

TE Part # CAT-104MTA-PRUSH
PCB Header: Polyester, Right Angle, Unshrouded



TE Part # CAT-104MTA-PVBRH
Polyester Vertical PCB Header: 2.54 mm, Breakaway, MTA 100



TE Part # 58246-2
MTA 100 CRIMP HEAD PRODUCTION DISCRETE



TE Part # CAT-104MTA-PVUNH
PCB Header: Polyester, Vertical, Unshrouded, No Mating Alignment



TE Part # CAT-104MTA-NVTHH
Nylong Vertical PCB Header: 2.54mm, Through Hole, MTA 100



TE Part # 58246-3
MTA 100 CRIMP HEAD PRODUCTION RBBN CABLE



TE Part # 58579-1
MTA 100 MANUAL TOOL ASSEMBLY DISCRETE



TE Part # CAT-104MTA-NYLCC
Nylon PCB Connector Covers: 2.54 mm, MTA 100



TE Part # 3-644694-2
02P MTA100 R/A HDR RETENTIVE



TE Part # CAT-104MTA-PRUMH
PCB Header: Polyester, Right Angle, 2.54 mm



TE Part # 58074-1
MTA 50/100/156 MANUAL TOOL FRAME

Also in the Series | **MTA 100**



Connector Caps & Covers(69)



Connector Contacts(8)



Connector Hardware(1)



Insertion & Extraction Tools(2)



PCB Headers & Receptacles(441)



Rectangular Power Connectors(1)

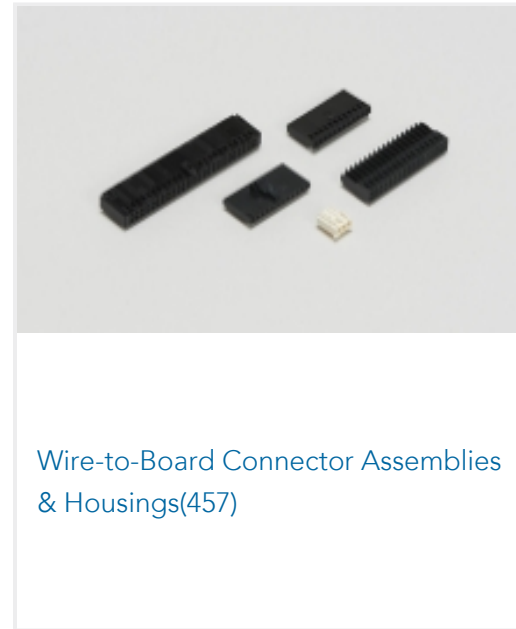

Wire-to-Board Connector Assemblies & Housings(457)



Wire-to-Board Headers & Receptacles (441)

Customers Also Bought



TE Part #114017-ZZ
SEALING PLUG, SIZE 12/16, WHT

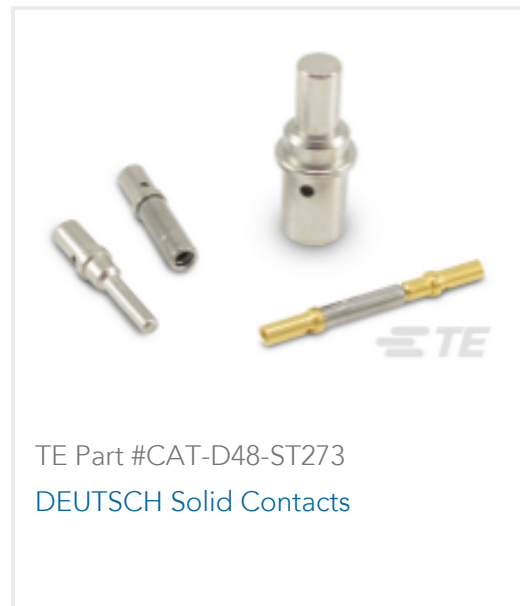

TE Part #CAT-D48-ST273
DEUTSCH Solid Contacts



TE Part #DT04-2P
REC, 2P, GRY, N



TE Part #CAT-D487-W416
Wedgelocks: DEUTSCH DT



TE Part #DT06-2S
PLG, 2P, GRY, N

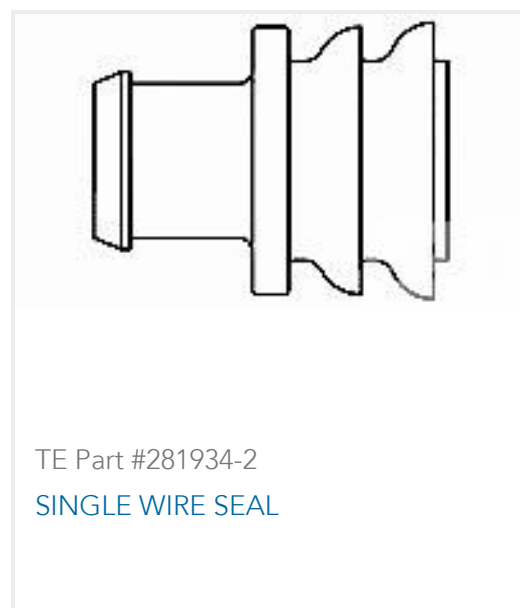

TE Part #281934-2
SINGLE WIRE SEAL

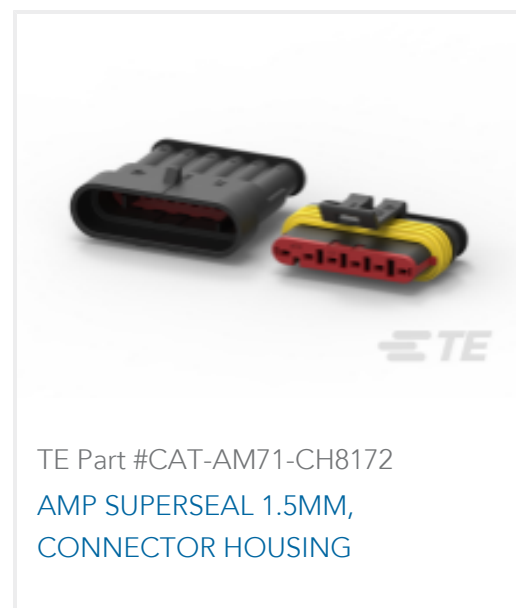

TE Part #CAT-AM71-CH8172
AMP SUPERSEAL 1.5MM,
CONNECTOR HOUSING

Documents

Product Drawings

[02P MTA100 CONN ASSY ON TAPE](#)

English

CAD Files

[Customer View Model](#)

[ENG_CVM_CVM_3-640470-2_AB.2d_dxf.zip](#)

English

[3D PDF](#)



3D

Customer View Model

[ENG_CVM_CVM_3-640470-2_AB.3d_igs.zip](#)

English

Customer View Model

[ENG_CVM_CVM_3-640470-2_AB.3d_stp.zip](#)

English

By downloading the CAD file I accept and agree to the [Terms and Conditions](#) of use.

Product Specifications

[Application Specification](#)

English

Agency Approvals

[Agency Approval Document](#)

English