

3-644457-6 ✓ ACTIVE



MTA 100

TE Internal #: 3-644457-6

PCB Mount Header, Right Angle, Wire-to-Board, 6 Position, 2.54 mm [.1 in] Centerline, Breakaway, Tin (Sn), Through Hole - Solder, Signal, MTA 100

[View on TE.com >](#)

Connectors > PCB Connectors > PCB Headers & Receptacles > PCB Header: Polyester, Right Angle, Unshrouded

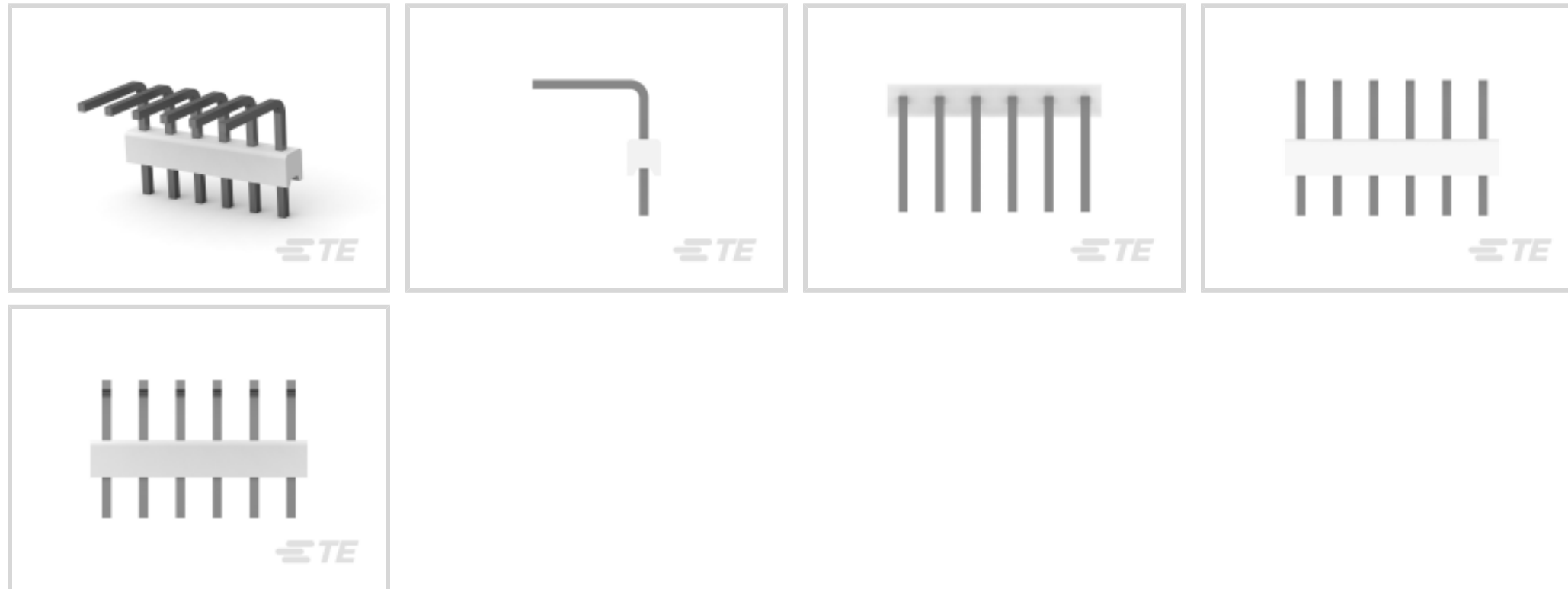

PCB Connector Type: **PCB Mount Header**

PCB Mount Orientation: **Right Angle**

Connector System: **Wire-to-Board**

Number of Positions: **6**

Centerline (Pitch): **2.54 mm [.1 in]**

[All PCB Header: Polyester, Right Angle, Unshrouded \(80\)](#)

Features

Product Type Features

PCB Connector Type	PCB Mount Header
Connector System	Wire-to-Board
Header Type	Breakaway
Sealable	No
Connector & Contact Terminates To	Printed Circuit Board
Connector Product Type	Connector Assembly

Configuration Features

Number of Columns	6
PCB Mount Orientation	Right Angle
Number of Positions	6
Number of Rows	1

Electrical Characteristics



Operating Voltage	250 VAC
-------------------	---------

Body Features

Connector Profile	Narrow
-------------------	--------

Primary Product Color	Natural
-----------------------	---------

Contact Features

Contact Underplating Material	Nickel
-------------------------------	--------

Contact Underplating Material Thickness	1.27 μ m[50 μ in]
---	---------------------------

PCB Contact Termination Area Plating Material Finish	Matte
--	-------

Mating Square Post Dimension	.64 mm[.025 in]
------------------------------	-----------------

PCB Contact Termination Area Plating Material Thickness	3.81 – 8.89 μ m[150 – 350 μ in]
---	---

Contact Shape & Form	Square
----------------------	--------

Contact Layout	Inline
----------------	--------

Contact Mating Area Length	6.6 mm[.26 in]
----------------------------	----------------

Contact Base Material	Copper Alloy
-----------------------	--------------

PCB Contact Termination Area Plating Material	Tin
---	-----

Contact Mating Area Plating Material	Tin (Sn)
--------------------------------------	----------

Contact Mating Area Plating Material Finish	Matte
---	-------

Contact Mating Area Plating Material Thickness	3.81 μ m[150 μ in]
--	----------------------------

Contact Type	Pin
--------------	-----

Contact Current Rating (Max)	5 A
------------------------------	-----

Termination Features

Termination Post & Tail Length	2.79 mm[.11 in]
--------------------------------	-----------------

Square Termination Post & Tail Dimension	.64 mm[.025 in]
--	-----------------

Termination Method to PCB	Through Hole - Solder
---------------------------	-----------------------

Mechanical Attachment

Panel Mount Feature	Without
---------------------	---------

Mating Alignment Type	Polarization
-----------------------	--------------

PCB Mount Alignment	Without
---------------------	---------

Mating Retention	Without
------------------	---------

PCB Mount Retention	Without
---------------------	---------

Connector Mounting Type	Board Mount
-------------------------	-------------

Mating Alignment	With
------------------	------



Housing Features

Centerline (Pitch)	2.54 mm [.1 in]
Housing Material	Polyester GF

Dimensions

Connector Width	8.94 mm [.352 in]
PCB Thickness (Recommended)	1.6 mm [.063 in]
Connector Height	6.65 mm [.262 in]
Connector Length	14.94 mm [.588 in]

Usage Conditions

Operating Temperature Range	-55 – 105 °C [-67 – 221 °F]
-----------------------------	-----------------------------

Operation/Application

Circuit Application	Signal
---------------------	--------

Industry Standards

Compatible With Agency/Standards Products	CSA, UL
Compatible With Approved Standards Products	CSA LR7189, UL E28476
UL Flammability Rating	UL 94V-0

Packaging Features

Packaging Quantity	500
Packaging Method	Bag, Box

Product Compliance

[For compliance documentation, visit the product page on TE.com>](#)

EU RoHS Directive 2011/65/EU	Compliant
EU ELV Directive 2000/53/EC	Compliant
China RoHS 2 Directive MIIT Order No 32, 2016	No Restricted Materials Above Threshold
EU REACH Regulation (EC) No. 1907/2006	Current ECHA Candidate List: JUNE 2025 (250) Candidate List Declared Against: JUNE 2025 (250) Does not contain REACH SVHC
Halogen Content	Not Low Halogen - contains Br or Cl > 900 ppm.
Solder Process Capability	Wave solder capable to 240°C

Product Compliance Disclaimer

This information is provided based on reasonable inquiry of our suppliers and represents our current actual knowledge based on the information they provided. This information is subject to change. The part numbers that TE has identified as EU RoHS compliant have a maximum concentration of 0.1% by weight in homogenous materials for lead, hexavalent chromium, mercury, PBB, PBDE, DBP, BBP, DEHP, DIBP, and 0.01% for cadmium, or qualify for an exemption to these limits as defined in the Annexes of Directive 2011/65/EU (RoHS2). Finished electrical and electronic equipment products will be CE marked as required by Directive 2011/65/EU. Components may not be CE marked. Additionally, the part numbers that TE has identified as EU ELV compliant have a maximum concentration of 0.1% by weight in homogenous materials for lead, hexavalent chromium, and mercury, and 0.01% for cadmium, or qualify for an exemption to these limits as defined in the Annexes of Directive 2000/53/EC (ELV). Regarding the REACH Regulation, the information TE provides on SVHC in articles for this part number is based on the latest European Chemicals Agency (ECHA) 'Guidance on requirements for substances in articles' posted at this URL: <https://echa.europa.eu/guidance-documents/guidance-on-reach>

Compatible Parts



TE Part # 1375820-6
CST-100 II HOUSING 6 POS



TE Part # CAT-104MTA-NTPNR
MTA Receptacle: Nylon, Tin Plated, 2.54 mm



TE Part # CAT-104MTA-PLSCC
Polyester PCB Connector Covers: 2.54 mm, MTA 100



TE Part # CAT-104MTA-NTPMR
Nylon Tin Plated Receptacle: 2.54 mm, with Mating Alignment, MTA 100



TE Part # CAT-104MTA-NYLCC
Nylon PCB Connector Covers: 2.54 mm, MTA 100

Also in the Series | MTA 100



Connector Caps & Covers(69)



Connector Contacts(8)



Connector Hardware(1)



Insertion & Extraction Tools(2)

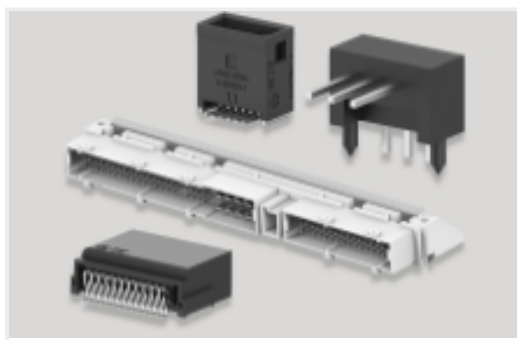

PCB Headers & Receptacles(441)



Rectangular Power Connectors(1)



Wire-to-Board Connector Assemblies & Housings(457)

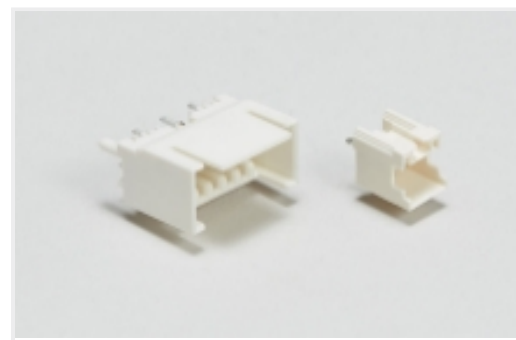

Wire-to-Board Headers & Receptacles (441)

Customers Also Bought



TE Part #154765-E
SMCB 50 M AB VV 7-03 CL * 0007 137 E004



TE Part #CON SMA012
SMA RA Plug 50 Ohm Cable Crimp



TE Part #816485-SF
RN102-0.6-02-4M4



TE Part #3-338169-2
15P HDP20 PLUG ASSY

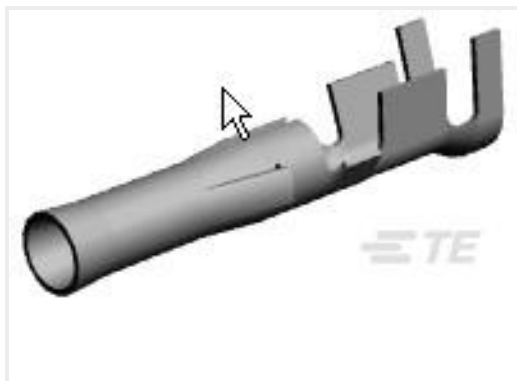

TE Part #770144-5
.093 CP&S SOC AUBR L/P 20-14



TE Part #5-2176330-5
CRGP 2010 330K 1%

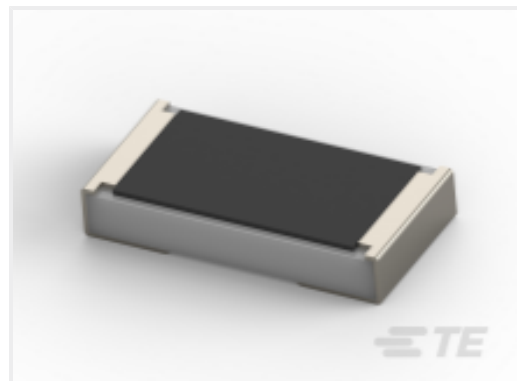

TE Part #2176468-2
TLRP 2010 1.0W R020 1% 75PPM 4K RL

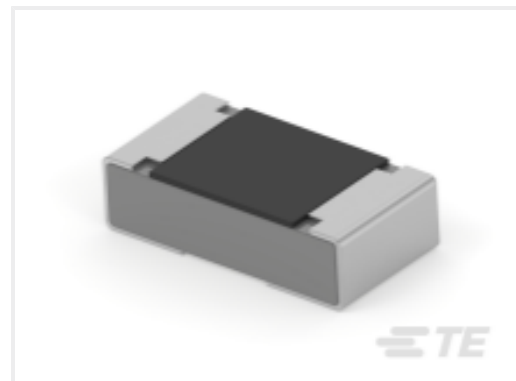

TE Part #5-2176479-8
RA73F 1J 200R 0.1% 5K RL



TE Part #2176526-8
3503G 2B 60R4 1% 5K RL



TE Part #5556591-1
MJ,LPF,R/A,8P/8C,SHLD,KEYEDP

Documents

Product Drawings

[06P MTA100 HDR ASSY R/A NARROW](#)

English

CAD Files

[3D PDF](#)

3D

Customer View Model

[ENG_CVM_CVM_3-644457-6_J.2d_dxf.zip](#)



English

Customer View Model

[ENG_CVM_CVM_3-644457-6_J.3d_igs.zip](#)

English

Customer View Model

[ENG_CVM_CVM_3-644457-6_J.3d_stp.zip](#)

English

3D PDF

English

Customer View Model

[ENG_CVM_3-644457-6_E1.3d_igs.zip](#)

English

Customer View Model

[ENG_CVM_3-644457-6_E1.3d_stp.zip](#)

English

Customer View Model

[ENG_CVM_3-644457-6_E1.2d_dxf.zip](#)

English

By downloading the CAD file I accept and agree to the [Terms and Conditions](#) of use.

Product Specifications

[Application Specification](#)

English

Agency Approvals

[Agency Approval Document](#)

English