

3-644466-3 ✓ ACTIVE



MTA 156

TE Internal #: 3-644466-3

3 Position, Receptacle, Connector Assembly, Insulation

Displacement (IDC), Wire-to-Board, Tin (Sn), UL 94V-2, 3.96 mm [

156 in] Centerline, MTA 156

[View on TE.com >](#)

Connectors > Rectangular Connectors > Standard Rectangular Connectors

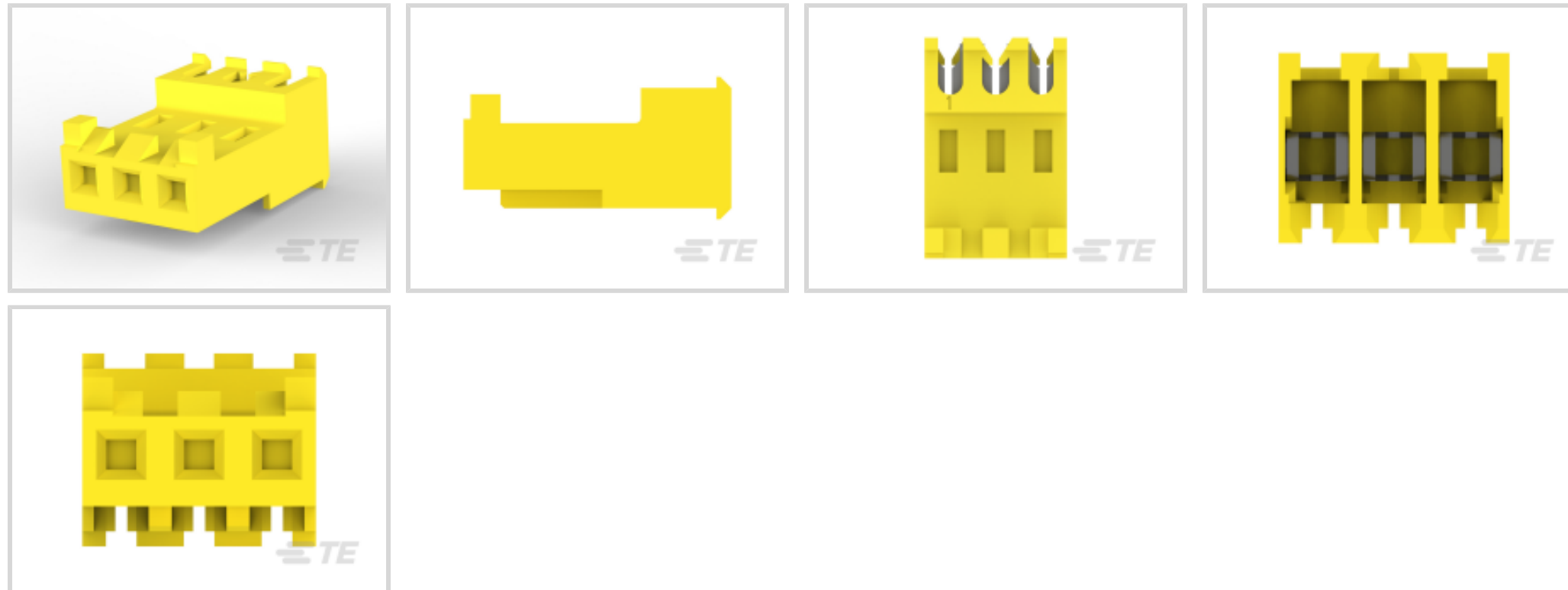

Connector Product Type: **Connector Assembly**

Mating Alignment: **With**

Mating Alignment Type: **Polarizing Tab**

Connector & Housing Type: **Receptacle**

Mating Retention Type: **Locking Ramp**

Features

Product Type Features

Compatible With Discrete Wire Type	Stranded
Connector Product Type	Connector Assembly
Connector & Housing Type	Receptacle
Connector System	Wire-to-Board
Sealable	No
Connector & Contact Terminates To	Wire & Cable

Configuration Features

Number of Positions	3
Number of Rows	1
Number of Power Positions	3

Electrical Characteristics

Operating Voltage	600 VAC
-------------------	---------

Body Features

Primary Product Color	Yellow
-----------------------	--------

Cable Exit Angle	90°
------------------	-----

Contact Features

Contact Underplating Material	Nickel
Contact Underplating Material Thickness	30 µm[.762 µin]
Contact Layout	Inline
Contact Base Material	Copper Alloy
Wire Contact Termination Area Plating Thickness	2.03 – 5.08 µm[80 – 200 µin]
Contact Mating Area Plating Material Finish	Matte
Contact Mating Area Plating Material	Tin (Sn)
Contact Retention Within Housing	With
Contact Current Rating (Max)	7 A
Contact Type	Receptacle
Wire Contact Termination Area Plating Material	Tin
Contact Mating Area Plating Material Thickness	2.03 µm[80 µin]

Termination Features

Termination Method to Wire & Cable	Insulation Displacement (IDC)
------------------------------------	-------------------------------

Mechanical Attachment

Strain Relief	With
Panel Mount Feature	Without
Contact Retention Type Within Housing	Locking Lance
Mating Alignment	With
Mating Alignment Type	Polarizing Tab
Mating Retention Type	Locking Ramp
Mating Retention	With
Connector Mounting Type	Cable Mount (Free-Hanging)

Housing Features

Wire & Cable IDC Installation Type	Feed Through
Centerline (Pitch)	3.96 mm[.156 in]
Housing Material	Nylon

Dimensions

Compatible Insulation Diameter Range	2.41 mm[.095 in]
Connector Height	9.78 mm[.385 in]



Connector Length	11.89 mm[.468 in]
------------------	-------------------

Wire Size	.5 – .6 mm ²
-----------	-------------------------

Usage Conditions

Operating Temperature Range	-55 – 105 °C[-67 – 221 °F]
-----------------------------	----------------------------

Operation/Application

Circuit Application	Power & Signal
---------------------	----------------

Industry Standards

Compatible With Agency/Standards Products	CSA, UL
---	---------

UL Rating	Recognized
-----------	------------

Compatible With Approved Standards Products	UL E28476
---	-----------

CSA Rating	Certified, LR 7189
------------	--------------------

UL Flammability Rating	UL 94V-2
------------------------	----------

Glow Wire Rating	Standard Part - Not Glow Wire
------------------	-------------------------------

Packaging Features

Packaging Quantity	500
--------------------	-----

Packaging Method	Bag
------------------	-----

Product Compliance

[For compliance documentation, visit the product page on TE.com>](#)

EU RoHS Directive 2011/65/EU	Compliant
------------------------------	-----------

EU ELV Directive 2000/53/EC	Compliant
-----------------------------	-----------

China RoHS 2 Directive MIIT Order No 32, 2016	No Restricted Materials Above Threshold
---	---

EU REACH Regulation (EC) No. 1907/2006	Current ECHA Candidate List: JUNE 2025 (250) Candidate List Declared Against: JUNE 2025 (250) Does not contain REACH SVHC
--	---

Halogen Content	Low Halogen - Br, Cl, F < 900 ppm per homogenous material. Also BFR/CFR/PVC Free
-----------------	--

Solder Process Capability	Not applicable for solder process capability
---------------------------	--

Product Compliance Disclaimer

This information is provided based on reasonable inquiry of our suppliers and represents our current actual knowledge based on the information they provided. This information is subject to change. The part numbers that TE has identified as EU RoHS compliant have a maximum concentration of 0.1% by weight in homogenous materials for lead, hexavalent chromium, mercury, PBB, PBDE, DBP, BBP, DEHP, DIBP, and 0.01% for cadmium, or qualify for an exemption to these

limits as defined in the Annexes of Directive 2011/65/EU (RoHS2). Finished electrical and electronic equipment products will be CE marked as required by Directive 2011/65/EU. Components may not be CE marked. Additionally, the part numbers that TE has identified as EU ELV compliant have a maximum concentration of 0.1% by weight in homogenous materials for lead, hexavalent chromium, and mercury, and 0.01% for cadmium, or qualify for an exemption to these limits as defined in the Annexes of Directive 2000/53/EC (ELV). Regarding the REACH Regulation, the information TE provides on SVHC in articles for this part number is based on the latest European Chemicals Agency (ECHA) 'Guidance on requirements for substances in articles' posted at this URL: <https://echa.europa.eu/guidance-documents/guidance-on-reach>

Compatible Parts





Also in the Series | **MTA 156**

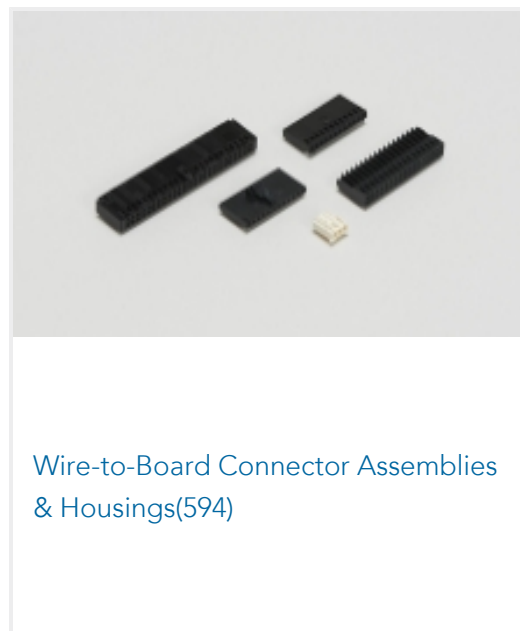
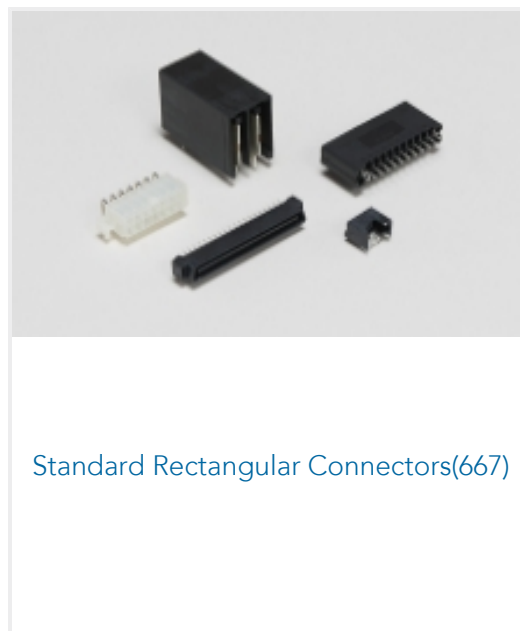
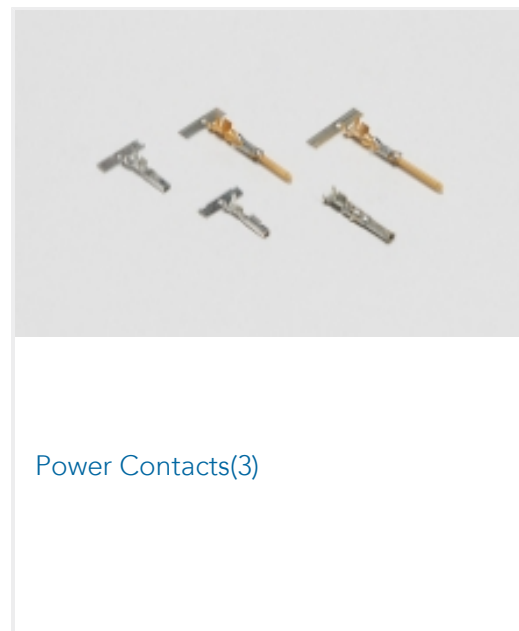
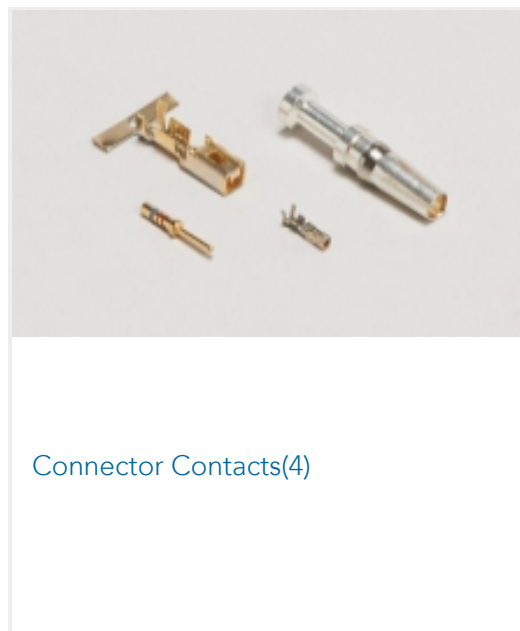

Customers Also Bought

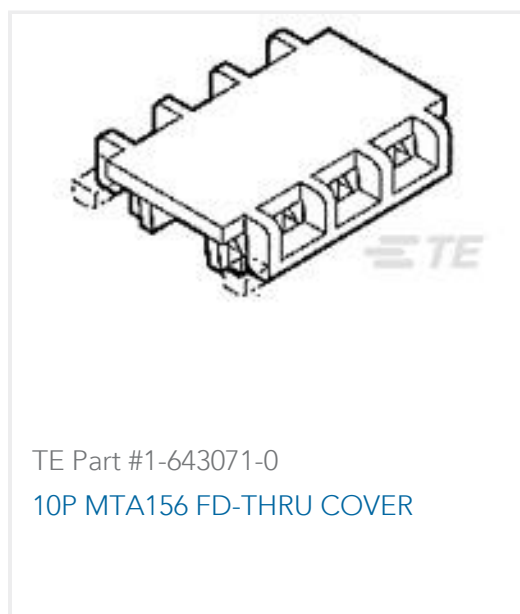
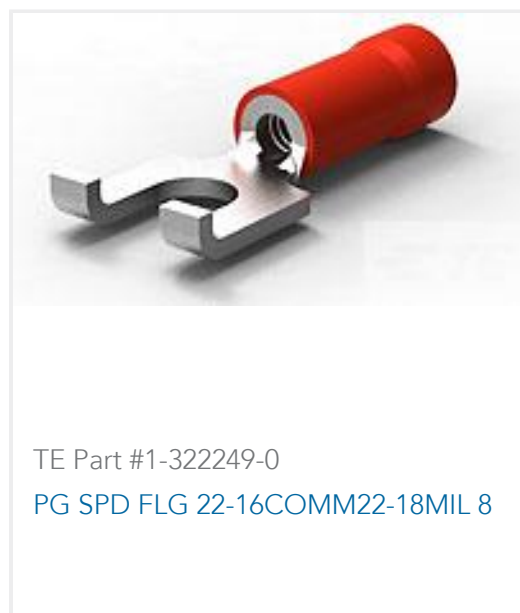



Documents

Product Drawings

[03P MTA156 CONN ASSY 20AWG YEL](#)

English

CAD Files

[3D PDF](#)

3D

Customer View Model

[ENG_CVM_CVM_3-644466-3_F.2d_dxf.zip](#)

English

Customer View Model

[ENG_CVM_CVM_3-644466-3_F.3d_igs.zip](#)

English

Customer View Model

[ENG_CVM_CVM_3-644466-3_F.3d_stp.zip](#)

English

By downloading the CAD file I accept and agree to the [Terms and Conditions](#) of use.

Product Specifications

[Application Specification](#)

English

[Application Specification](#)

Japanese

[Application Specification](#)

English

[MTA 156 Ribbon Cable Connector Assemblies \(English And Spanish\)](#)

English

[MTA 156 Ribbon Cable Connector Assemblies \(English And Spanish\)](#)

Japanese

Agency Approvals

[Agency Approval Document](#)

English