



MTA 100

TE Internal #: 3-644540-3

3 Position, Receptacle, Connector Assembly, Insulation
 Displacement (IDC), Wire-to-Board, Tin (Sn), Normal, UL 94V-2,
 MTA 100

[View on TE.com >](#)

Connectors > Rectangular Connectors > Standard Rectangular Connectors > Nylon Tin Plated Receptacle: 2.54 mm, with Mating Alignment, MTA 100

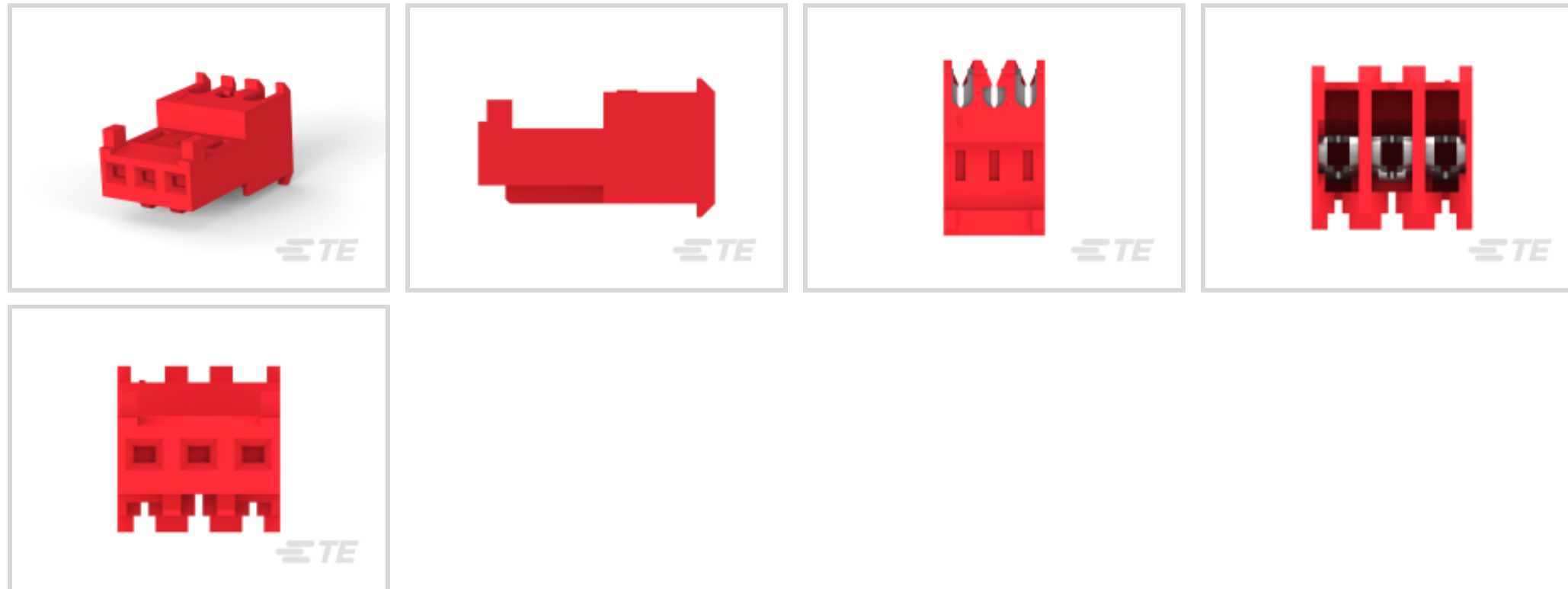

Connector Product Type: **Connector Assembly**

Mating Alignment: **With**

Mating Alignment Type: **Polarization**

Connector & Housing Type: **Receptacle**

Mating Retention Type: **Locking Ramp**

[All Nylon Tin Plated Receptacle: 2.54 mm, with Mating Alignment, MTA 100 \(127\)](#)

Features

Product Type Features

Compatible With Discrete Wire Type	Stranded
Connector Product Type	Connector Assembly
Connector & Housing Type	Receptacle
Connector System	Wire-to-Board
Insertion Force Type	Normal
Sealable	No
Connector & Contact Terminates To	Wire & Cable

Configuration Features

Number of Cavities	3
Contacts Preloaded	Yes
Number of Positions	3
Number of Rows	1



Electrical Characteristics

Operating Voltage	250 VAC
-------------------	---------

Body Features

Primary Product Color	Red
-----------------------	-----

Contact Features

Contact Underplating Material	Nickel
Wire Contact Termination Area Plating Material	Tin
Contact Type	Receptacle
Contact Mating Area Plating Material	Tin (Sn)
Contact Retention Within Housing	With
Contact Current Rating (Max)	5 A

Termination Features

Termination Method to Wire & Cable	Insulation Displacement (IDC)
------------------------------------	-------------------------------

Mechanical Attachment

Contact Retention Type Within Housing	Locking Lance
Mating Alignment	With
Mating Alignment Type	Polarization
Mating Retention Type	Locking Ramp
Mating Retention	With
Connector Mounting Type	Cable Mount (Free-Hanging)

Housing Features

Housing Material	Nylon
Centerline (Pitch)	2.54 mm[.1 in]

Dimensions

Connector Width	7.75 mm[.305 in]
Connector Height	13.21 mm[.52 in]
Wire Size	22 AWG
Connector Length	7.62 mm[.3 in]

Usage Conditions

Operating Temperature Range	-55 – 105 °C[-67 – 221 °F]
-----------------------------	----------------------------

Operation/Application

Shielded	No
----------	----

Circuit Application	Signal
---------------------	--------

Industry Standards

Compatible With Agency/Standards Products	CSA, UL
UL Rating	Recognized
Compatible With Approved Standards Products	UL E28476
CSA Rating	LR 7189
UL Flammability Rating	UL 94V-2

Packaging Features

Packaging Quantity	500
Packaging Method	Bag/Box

Product Compliance

[For compliance documentation, visit the product page on TE.com>](#)







EU RoHS Directive 2011/65/EU	Compliant
EU ELV Directive 2000/53/EC	Compliant
China RoHS 2 Directive MIIT Order No 32, 2016	No Restricted Materials Above Threshold
EU REACH Regulation (EC) No. 1907/2006	Current ECHA Candidate List: JUNE 2025 (250) Candidate List Declared Against: JUNE 2025 (250) Does not contain REACH SVHC
Halogen Content	BFR/CFR/PVC Free, but Br/Cl >900 ppm in other sources.
Solder Process Capability	Not applicable for solder process capability

Product Compliance Disclaimer

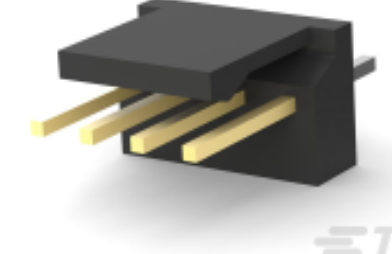
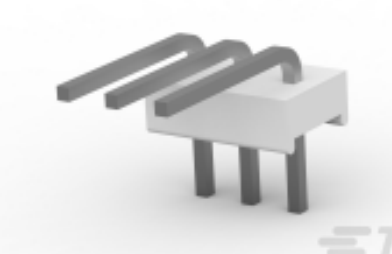
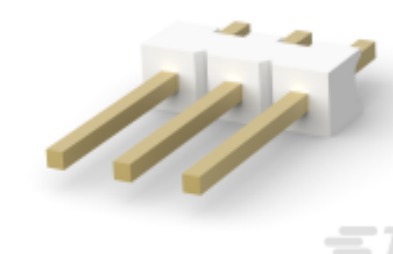

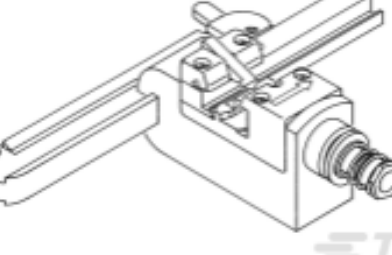
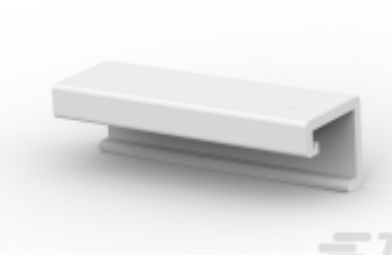
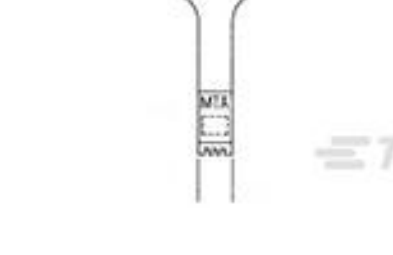
This information is provided based on reasonable inquiry of our suppliers and represents our current actual knowledge based on the information they provided. This information is subject to change. The part numbers that TE has identified as EU RoHS compliant have a maximum concentration of 0.1% by weight in homogenous materials for lead, hexavalent chromium, mercury, PBB, PBDE, DBP, BBP, DEHP, DIBP, and 0.01% for cadmium, or qualify for an exemption to these limits as defined in the Annexes of Directive 2011/65/EU (RoHS2). Finished electrical and electronic equipment products will be CE marked as required by Directive 2011/65/EU. Components may not be CE marked. Additionally, the part numbers that TE has identified as EU ELV compliant have a maximum concentration of 0.1% by weight in homogenous materials for lead, hexavalent chromium, and mercury, and 0.01% for cadmium, or qualify for an exemption to these limits as defined in the Annexes of Directive 2000/53/EC (ELV). Regarding the REACH Regulation, the information TE provides on SVHC in articles for this part number is based on the latest European Chemicals Agency (ECHA) 'Guidance on requirements for substances in articles' posted at this URL: <https://echa.europa.eu/guidance-documents/guidance-on-reach>

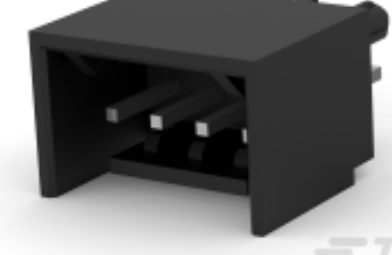
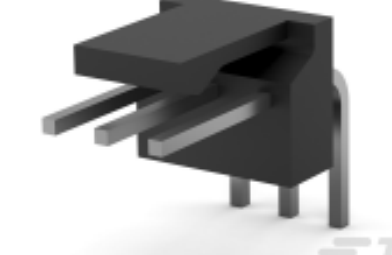
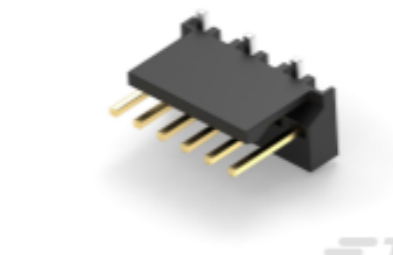
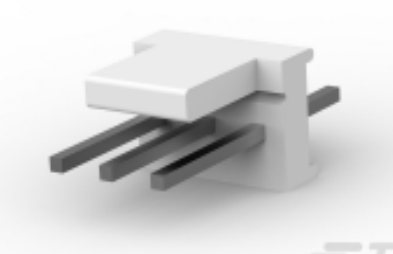
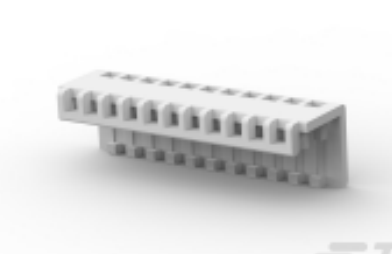
Compatible Parts



 <p>TE Part # CAT-104MTA-PVUNH PCB Header: Polyester, Vertical, Unshrouded, No Mating Alignment</p>	 <p>TE Part # CAT-104MTA-NVTHH Nylong Vertical PCB Header: 2.54mm, Through Hole, MTA 100</p>	 <p>TE Part # CAT-104MTA-PRUSH PCB Header: Polyester, Right Angle, Unshrouded</p>	 <p>TE Part # CAT-104MTA-PVBRH Polyester Vertical PCB Header: 2.54 mm, Breakaway, MTA 100</p>
 <p>TE Part # CAT-104MTA-PRSMH PCB Header, Right Angle, Polyester, 2.54 mm</p>	 <p>TE Part # 58442-1 MTA 100 CRIMP HEAD PRODUCTION FEED THRU</p>	 <p>TE Part # CAT-104MTA-PLSCC Polyester PCB Connector Covers: 2.54 mm, MTA 100</p>	 <p>TE Part # 59803-1 MAINTENANCE TOOL</p>
 <p>TE Part # 3-1744163-3 03P MTA100 HDR ASSY SM 30AU LF T&R</p>	 <p>TE Part # CAT-104MTA-PVSHH Polyester Vertical PCB Header: 2.54 mm, Shrouded, MTA 100</p>	 <p>TE Part # 3-647051-3 03P MTA100 HRD ASSY/L HT LF</p>	 <p>TE Part # CAT-104MTA-NVSMH PCB Header: Nylon, Vertical, Surface Mount, MTA 100</p>
 <p>TE Part # 640454-3 03P MTA100 HDR ASSY SQ STR POL</p>	 <p>TE Part # CAT-104MTA-NYLCC Nylon PCB Connector Covers: 2.54 mm, MTA 100</p>	 <p>TE Part # CAT-104MTA-PRUMH PCB Header: Polyester, Right Angle, 2.54 mm</p>	 <p>TE Part # 58074-1 MTA 50/100/156 MANUAL TOOL FRAME</p>

Also in the Series | **MTA 100**

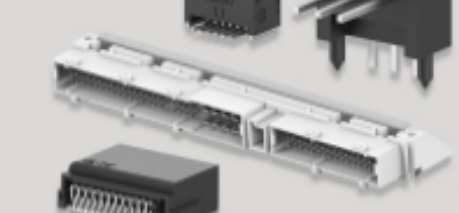
 <p>Connector Caps & Covers(69)</p>	 <p>Connector Contacts(8)</p>	 <p>Connector Hardware(1)</p>	 <p>PCB Headers & Receptacles(441)</p>
--	--	--	---



Rectangular Connector Housings(1)



Rectangular Power Connectors(1)

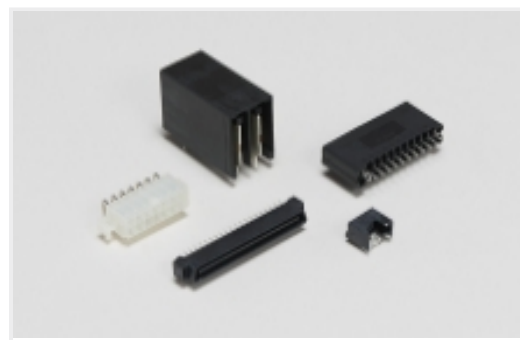

Standard Rectangular Connectors(496)

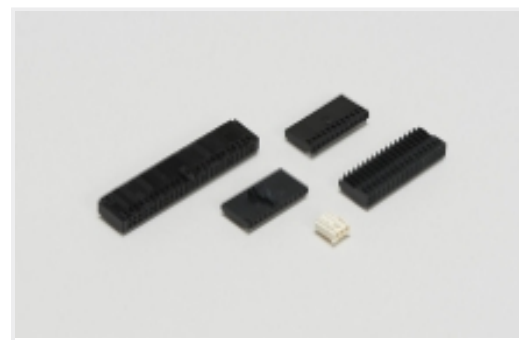

Wire-to-Board Connector Assemblies & Housings(457)

Customers Also Bought

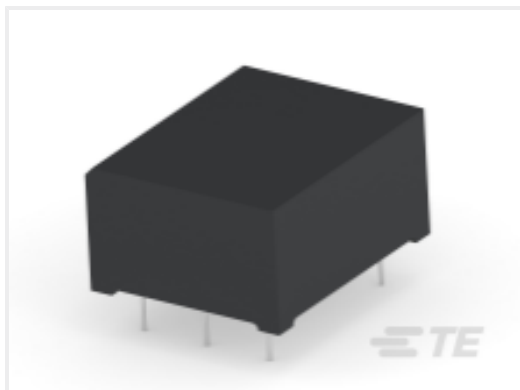

TE Part #800051-SF
IT233

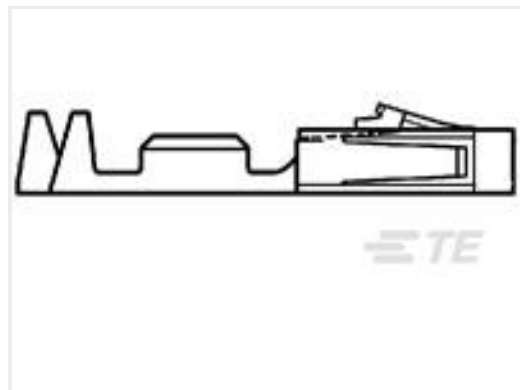

TE Part #1-104481-2
SHORT POINT RECP CONT LP



TE Part #CAT-104MTA-PVUMH
PCB Header: Polyester, Vertical, 2.54 mm



TE Part #3-643813-2
02P MTA100 CONN ASSY POL RIB



TE Part #3-644465-3
03P MTA156 CONN ASSY 18AWG ORA



TE Part #1367369-1
BUSBAR CONNECT W/CLINCH NUTS



TE Part #1415899-7
RZ01-1C4-D005



TE Part #6609006-9
6EEJ1=F8013 S0

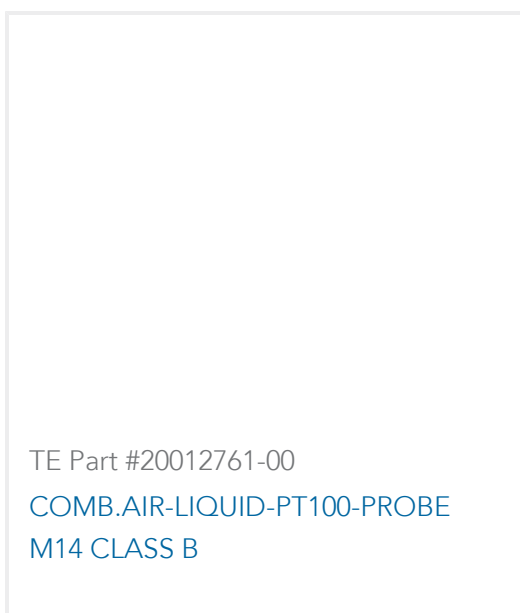

TE Part #20012761-00
COMB.AIR-LIQUID-PT100-PROBE M14 CLASS B

Documents

Product Drawings

[03P MTA100 CONN ASSY F/T W/LCK](#)

English

CAD Files

Customer View Model

[ENG_CVM_CVM_3-644540-3_F.2d_dxf.zip](#)

English

[3D PDF](#)



3D

Customer View Model

[ENG_CVM_CVM_3-644540-3_F.3d_igs.zip](#)

English

Customer View Model

[ENG_CVM_CVM_3-644540-3_F.3d_stp.zip](#)

English

By downloading the CAD file I accept and agree to the [Terms and Conditions](#) of use.

Product Specifications

[Application Specification](#)

English

Agency Approvals

[Agency Approval Document](#)

English