



MTA 100

TE Internal #: 3-644563-5

5 Position, Receptacle, Connector Assembly, Insulation  
 Displacement (IDC), Wire-to-Board, Tin (Sn), Normal, UL 94V-2,  
 MTA 100

[View on TE.com >](#)

Connectors > Rectangular Connectors > Standard Rectangular Connectors > Nylon Tin Plated Receptacle: 2.54 mm, with Mating Alignment, MTA 100

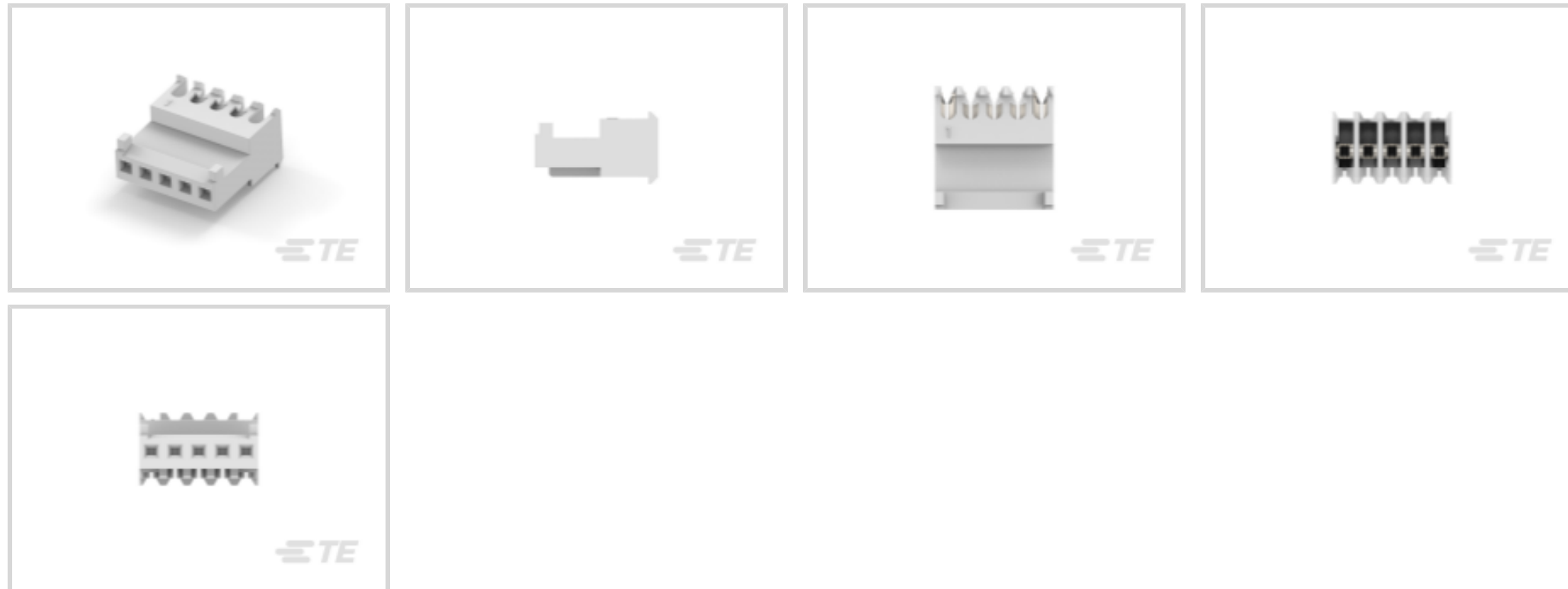

Connector Product Type: **Connector Assembly**

Mating Alignment: **With**

Mating Alignment Type: **Polarization**

Connector & Housing Type: **Receptacle**

Mating Retention Type: **Locking Ramp**

[All Nylon Tin Plated Receptacle: 2.54 mm, with Mating Alignment, MTA 100 \(127\)](#)

## Features

### Product Type Features

Compatible With Discrete Wire Type	Stranded
Connector Product Type	Connector Assembly
Connector & Housing Type	Receptacle
Connector System	Wire-to-Board
Insertion Force Type	Normal
Sealable	No
Connector & Contact Terminates To	Wire & Cable

### Configuration Features

Number of Cavities	5
Contacts Preloaded	Yes
Number of Positions	5
Number of Rows	1



### Electrical Characteristics

Operating Voltage	250 VAC
-------------------	---------

### Body Features

Primary Product Color	White
-----------------------	-------

### Contact Features

Contact Underplating Material	Nickel
Wire Contact Termination Area Plating Material	Tin
Contact Type	Receptacle
Contact Mating Area Plating Material	Tin (Sn)
Contact Retention Within Housing	With
Contact Current Rating (Max)	5 A

### Termination Features

Termination Method to Wire & Cable	Insulation Displacement (IDC)
------------------------------------	-------------------------------

### Mechanical Attachment

Contact Retention Type Within Housing	Locking Lance
Mating Alignment	With
Mating Alignment Type	Polarization
Mating Retention Type	Locking Ramp
Mating Retention	With
Connector Mounting Type	Cable Mount (Free-Hanging)

### Housing Features

Housing Material	Nylon
Centerline (Pitch)	2.54 mm[.1 in]

### Dimensions

Connector Width	7.75 mm[.305 in]
Connector Height	13.21 mm[.52 in]
Wire Size	24 AWG
Connector Length	12.7 mm[.5 in]

### Usage Conditions

Operating Temperature Range	-55 – 105 °C[-67 – 221 °F]
-----------------------------	----------------------------

### Operation/Application

Shielded	No
----------	----



Circuit Application	Signal
---------------------	--------

### Industry Standards

Compatible With Agency/Standards Products	CSA, UL
UL Rating	Recognized
Compatible With Approved Standards Products	UL E28476
CSA Rating	LR 7189
UL Flammability Rating	UL 94V-2

### Packaging Features

Packaging Quantity	500
Packaging Method	Box & Carton

### Product Compliance

[For compliance documentation, visit the product page on TE.com>](#)

EU RoHS Directive 2011/65/EU	Compliant
EU ELV Directive 2000/53/EC	Compliant
China RoHS 2 Directive MIIT Order No 32, 2016	No Restricted Materials Above Threshold
EU REACH Regulation (EC) No. 1907/2006	Current ECHA Candidate List: JUNE 2025 (250) Candidate List Declared Against: JUNE 2025 (250) Does not contain REACH SVHC
Halogen Content	Low Halogen - Br, Cl, F < 900 ppm per homogenous material. Also BFR/CFR/PVC Free
Solder Process Capability	Not applicable for solder process capability

#### Product Compliance Disclaimer

This information is provided based on reasonable inquiry of our suppliers and represents our current actual knowledge based on the information they provided. This information is subject to change. The part numbers that TE has identified as EU RoHS compliant have a maximum concentration of 0.1% by weight in homogenous materials for lead, hexavalent chromium, mercury, PBB, PBDE, DBP, BBP, DEHP, DIBP, and 0.01% for cadmium, or qualify for an exemption to these limits as defined in the Annexes of Directive 2011/65/EU (RoHS2). Finished electrical and electronic equipment products will be CE marked as required by Directive 2011/65/EU. Components may not be CE marked. Additionally, the part numbers that TE has identified as EU ELV compliant have a maximum concentration of 0.1% by weight in homogenous materials for lead, hexavalent chromium, and mercury, and 0.01% for cadmium, or qualify for an exemption to these limits as defined in the Annexes of Directive 2000/53/EC (ELV). Regarding the REACH Regulation, the information TE provides on SVHC in articles for this part number is based on the latest European Chemicals Agency (ECHA) 'Guidance on requirements for substances in articles' posted at this URL: <https://echa.europa.eu/guidance-documents/guidance-on-reach>

## Compatible Parts



TE Part # 58074-1  
MTA 50/100/156 MANUAL TOOL FRAME



TE Part # CAT-104MTA-NYLCC  
Nylon PCB Connector Covers: 2.54 mm, MTA 100



TE Part # CAT-104MTA-NVSMH  
PCB Header: Nylon, Vertical, Surface Mount, MTA 100



TE Part # CAT-104MTA-PVSHH  
Polyester Vertical PCB Header: 2.54 mm, Shrouded, MTA 100



TE Part # CAT-104MTA-NTPMP  
MTA Plug: Nylon, Tin Plated, 2.54 mm, with Mating Alignment

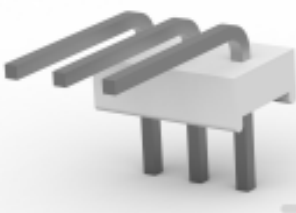

TE Part # CAT-104MTA-PRUSH  
PCB Header: Polyester, Right Angle, Unshrouded



TE Part # CAT-104MTA-PRSMH  
PCB Header, Right Angle, Polyester, 2.54 mm



TE Part # 59803-1  
MAINTENANCE TOOL



TE Part # 58442-1  
MTA 100 CRIMP HEAD PRODUCTION FEED THRU



TE Part # CAT-104MTA-PLSCC  
Polyester PCB Connector Covers: 2.54 mm, MTA 100



TE Part # CAT-104MTA-PVUNH  
PCB Header: Polyester, Vertical, Unshrouded, No Mating Alignment

Also in the Series | **MTA 100**



Connector Caps & Covers(69)



Connector Contacts(8)



Connector Hardware(1)



Insertion & Extraction Tools(2)



PCB Headers & Receptacles(441)



Rectangular Power Connectors(1)



Wire-to-Board Connector Assemblies & Housings(457)



Wire-to-Board Headers & Receptacles (441)

Customers Also Bought

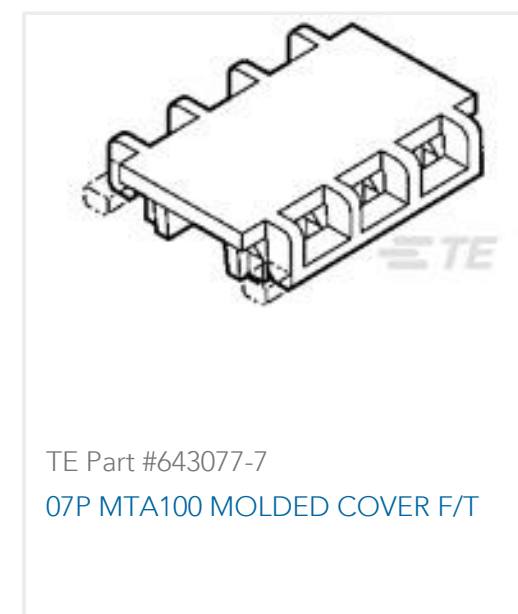

## Documents

### Product Drawings

[05P MTA100 CONN ASSY F/T 24AWG](#)

English

### CAD Files

[3D PDF](#)

3D

Customer View Model

[ENG\\_CVM\\_CVM\\_3-644563-5\\_H.2d\\_dxf.zip](#)

English

Customer View Model

[ENG\\_CVM\\_CVM\\_3-644563-5\\_H.3d\\_igs.zip](#)

English

Customer View Model

[ENG\\_CVM\\_CVM\\_3-644563-5\\_H.3d\\_stp.zip](#)

English

Customer View Model

[ENG\\_CVM\\_3-644563-5\\_G.3d\\_igs.zip](#)

English

Customer View Model

[ENG\\_CVM\\_3-644563-5\\_G.3d\\_stp.zip](#)

English

Customer View Model

[ENG\\_CVM\\_3-644563-5\\_G.2d\\_dxf.zip](#)

English

[3D PDF](#)

English



By downloading the CAD file I accept and agree to the [Terms and Conditions](#) of use.

---

### Product Specifications

#### Application Specification

English

---

### Agency Approvals

#### Agency Approval Document

English