

3-644861-4 ✓ ACTIVE



MTA 100

TE Internal #: 3-644861-4

PCB Mount Header, Vertical, Wire-to-Board, 14 Position, 2.54 mm [.1 in] Centerline, Fully Shrouded, Tin (Sn), Through Hole - Solder, Signal, MTA 100

[View on TE.com >](#)

Connectors > PCB Connectors > PCB Headers & Receptacles > Polyester Vertical PCB Header: 2.54mm, Shrouded, MTA 100

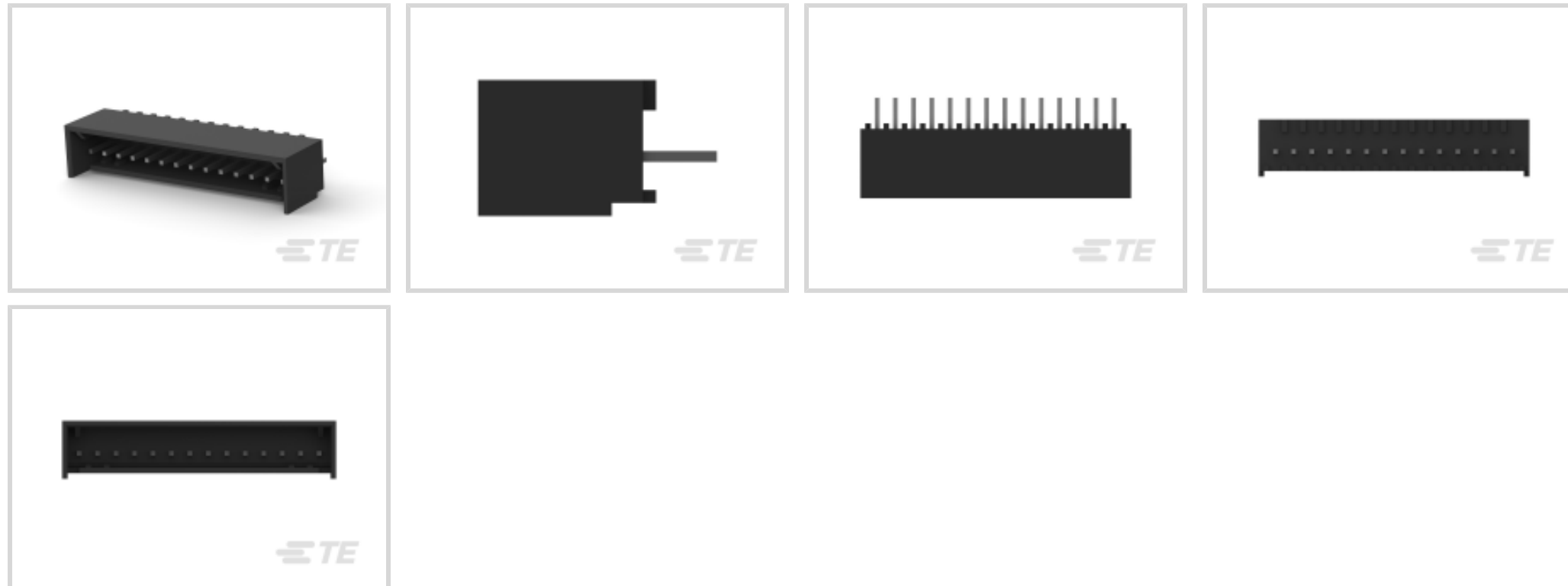

PCB Connector Type: **PCB Mount Header**

PCB Mount Orientation: **Vertical**

Connector System: **Wire-to-Board**

Number of Positions: **14**

Centerline (Pitch): **2.54 mm [.1 in]**

[All Polyester Vertical PCB Header: 2.54mm, Shrouded, MTA 100 \(37\)](#)

Features

Product Type Features

PCB Connector Type	PCB Mount Header
Connector System	Wire-to-Board
Header Type	Fully Shrouded
Sealable	No
Connector & Contact Terminates To	Printed Circuit Board
Connector Product Type	Connector Assembly

Configuration Features

PCB Mount Orientation	Vertical
Number of Positions	14
Number of Rows	1

Electrical Characteristics

Operating Voltage	250 VAC
-------------------	---------



Body Features

Primary Product Color	Black
-----------------------	-------

Contact Features

Contact Underplating Material	Nickel
Contact Underplating Material Thickness	1.27 μm [50 μin]
PCB Contact Termination Area Plating Material Finish	Matte
Mating Square Post Dimension	.64 mm[.025 in]
PCB Contact Termination Area Plating Material Thickness	3.81 – 6.35 μm [150 – 350 μin]
Contact Shape & Form	Square
Contact Layout	Inline
Contact Mating Area Length	5.1 mm[.2 in]
Contact Base Material	Copper Alloy
PCB Contact Termination Area Plating Material	Tin
Contact Mating Area Plating Material	Tin (Sn)
Contact Mating Area Plating Material Finish	Matte
Contact Mating Area Plating Material Thickness	3.81 – 6.3 μm [150 – 250 μin]
Contact Type	Pin
Contact Current Rating (Max)	5 A

Termination Features

Termination Post & Tail Length	3.56 mm[.14 in]
Square Termination Post & Tail Dimension	.64 mm[.025 in]
Termination Method to PCB	Through Hole - Solder

Mechanical Attachment

Panel Mount Feature	Without
Mating Retention Type	Friction Lock
Mating Alignment Type	Polarization
PCB Mount Alignment	Without
Mating Retention	With
PCB Mount Retention	Without
Connector Mounting Type	Board Mount
Mating Alignment	With

Housing Features

--	--



Centerline (Pitch)	2.54 mm [.1 in]
--------------------	-----------------

Housing Material	Polyester GF
------------------	--------------

Dimensions

PCB Thickness (Recommended)	1.57 mm [.062 in]
-----------------------------	-------------------

Connector Height	10.41 mm [.41 in]
------------------	-------------------

Connector Length	11.76 mm [.463 in]
------------------	--------------------

Usage Conditions

Operating Temperature Range	-55 – 105 °C [-67 – 221 °F]
-----------------------------	-----------------------------

Operation/Application

Circuit Application	Signal
---------------------	--------

Industry Standards

Compatible With Agency/Standards Products	CSA, UL
---	---------

Compatible With Approved Standards Products	CSA LR7189, UL E28476
---	-----------------------

UL Flammability Rating	UL 94V-0
------------------------	----------

Packaging Features

Packaging Quantity	500
--------------------	-----

Packaging Method	Package
------------------	---------

Product Compliance

[For compliance documentation, visit the product page on TE.com>](#)

EU RoHS Directive 2011/65/EU	Compliant
------------------------------	-----------

EU ELV Directive 2000/53/EC	Compliant
-----------------------------	-----------

China RoHS 2 Directive MIIT Order No 32, 2016	No Restricted Materials Above Threshold
---	---

EU REACH Regulation (EC) No. 1907/2006	Current ECHA Candidate List: JUNE 2025 (250) Candidate List Declared Against: JUNE 2025 (250) Does not contain REACH SVHC
--	---

Halogen Content	Not Low Halogen - contains Br or Cl > 900 ppm.
-----------------	--

Solder Process Capability	Wave solder capable to 240°C
---------------------------	------------------------------

Product Compliance Disclaimer

This information is provided based on reasonable inquiry of our suppliers and represents our current actual knowledge based on the information they provided. This information is subject to change. The part numbers that TE has identified as EU RoHS compliant have a maximum concentration of 0.1% by weight in homogenous materials for lead, hexavalent

chromium, mercury, PBB, PBDE, DBP, BBP, DEHP, DIBP, and 0.01% for cadmium, or qualify for an exemption to these limits as defined in the Annexes of Directive 2011/65/EU (RoHS2). Finished electrical and electronic equipment products will be CE marked as required by Directive 2011/65/EU. Components may not be CE marked. Additionally, the part numbers that TE has identified as EU ELV compliant have a maximum concentration of 0.1% by weight in homogenous materials for lead, hexavalent chromium, and mercury, and 0.01% for cadmium, or qualify for an exemption to these limits as defined in the Annexes of Directive 2000/53/EC (ELV). Regarding the REACH Regulation, the information TE provides on SVHC in articles for this part number is based on the latest European Chemicals Agency (ECHA) 'Guidance on requirements for substances in articles' posted at this URL: <https://echa.europa.eu/guidance-documents/guidance-on-reach>

Compatible Parts



TE Part # CAT-104MTA-NYLCC
Nylon PCB Connector Covers: 2.54 mm, MTA 100



TE Part # CAT-104MTA-NTPMR
Nylon Tin Plated Receptacle: 2.54 mm, with Mating Alignment, MTA 100



TE Part # 1-640550-4
14P MTA100 COVER



TE Part # CAT-104MTA-NTPNR
MTA Receptacle: Nylon, Tin Plated, 2.54 mm

Also in the Series | MTA 100



Connector Caps & Covers(69)



Connector Contacts(8)

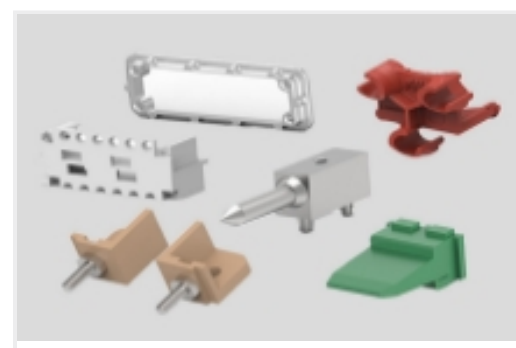

Connector Hardware(1)

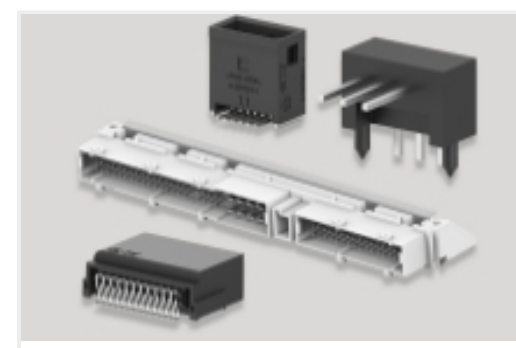

PCB Headers & Receptacles(441)

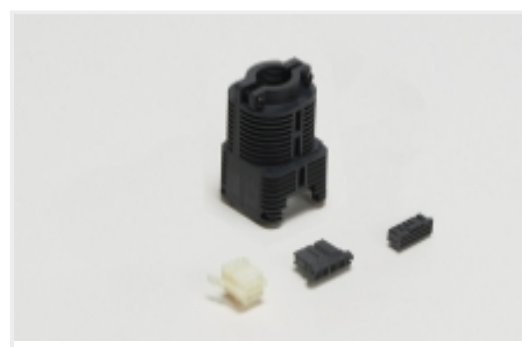

Rectangular Connector Housings(1)



Rectangular Power Connectors(1)

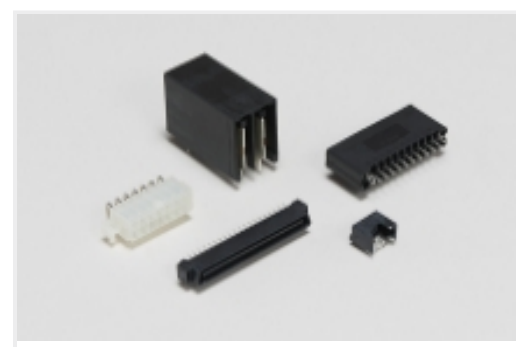

Standard Rectangular Connectors(496)

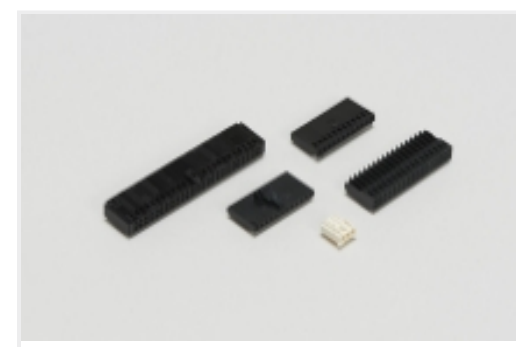

Wire-to-Board Connector Assemblies & Housings(457)

Customers Also Bought



TE Part #41290
250 FASTON,TAB,BR



TE Part #205204-4
CRIMP SNAP PLUG ASSY,SIZE 1



TE Part #206227-1
23-7 RECEPT REV SEX



TE Part #350550-7
UMNL SOK 20-14 AU/BR L/P



TE Part #4-640440-4
14P MTA100 CONN ASSY 22AWG RED



TE Part #4-641217-0
10P MTA156 CONN ASSY 18AWG ORA

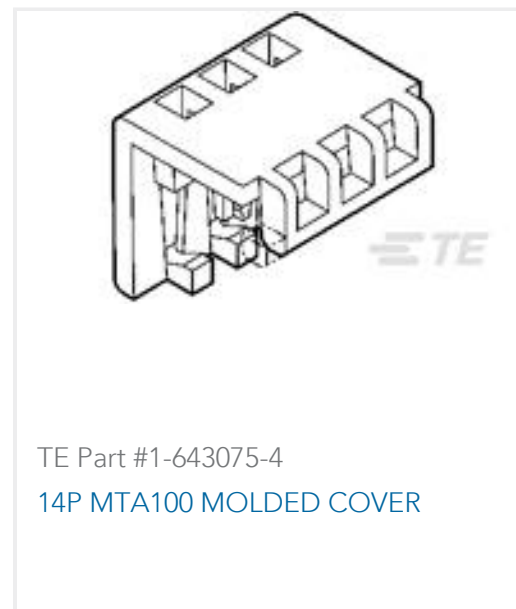

TE Part #1-643075-4
14P MTA100 MOLDED COVER



TE Part #2149966-1
MiniSAS HD, 1x2 Rec Assy



TE Part #2-2176337-9
CRGCO 0402 2K2 1%



TE Part #5206473-3
SADDLE WASHER,SPECIAL,ZN PLTD

Documents

Product Drawings

[14P MTA100 SHRD HDR,W/O PEG SN](#)

English

CAD Files

[3D PDF](#)

3D

Customer View Model

[ENG_CVM_CVM_3-644861-4_N_c-3-644861-4-n.2d_dxf.zip](#)

English

Customer View Model

[ENG_CVM_CVM_3-644861-4_N_c-3-644861-4-n.3d_igs.zip](#)

English

Customer View Model

[ENG_CVM_CVM_3-644861-4_N_c-3-644861-4-n.3d_stp.zip](#)

English

By downloading the CAD file I accept and agree to the [Terms and Conditions](#) of use.

Product Specifications



Application Specification

English

Agency Approvals

UL

English