

3-647001-2 ✓ ACTIVE



MTA 100

TE Internal #: 3-647001-2

2 Position, Plug, Connector Assembly, Insulation Displacement (IDC), Wire-to-Wire, Tin (Sn), Normal, UL 94V-2, 2.54 mm [.1 in] Centerline, MTA 100

[View on TE.com >](#)

Connectors > Rectangular Connectors > Standard Rectangular Connectors > MTA Plug: Nylon, Tin Plated, 2.54 mm, with Mating Alignment

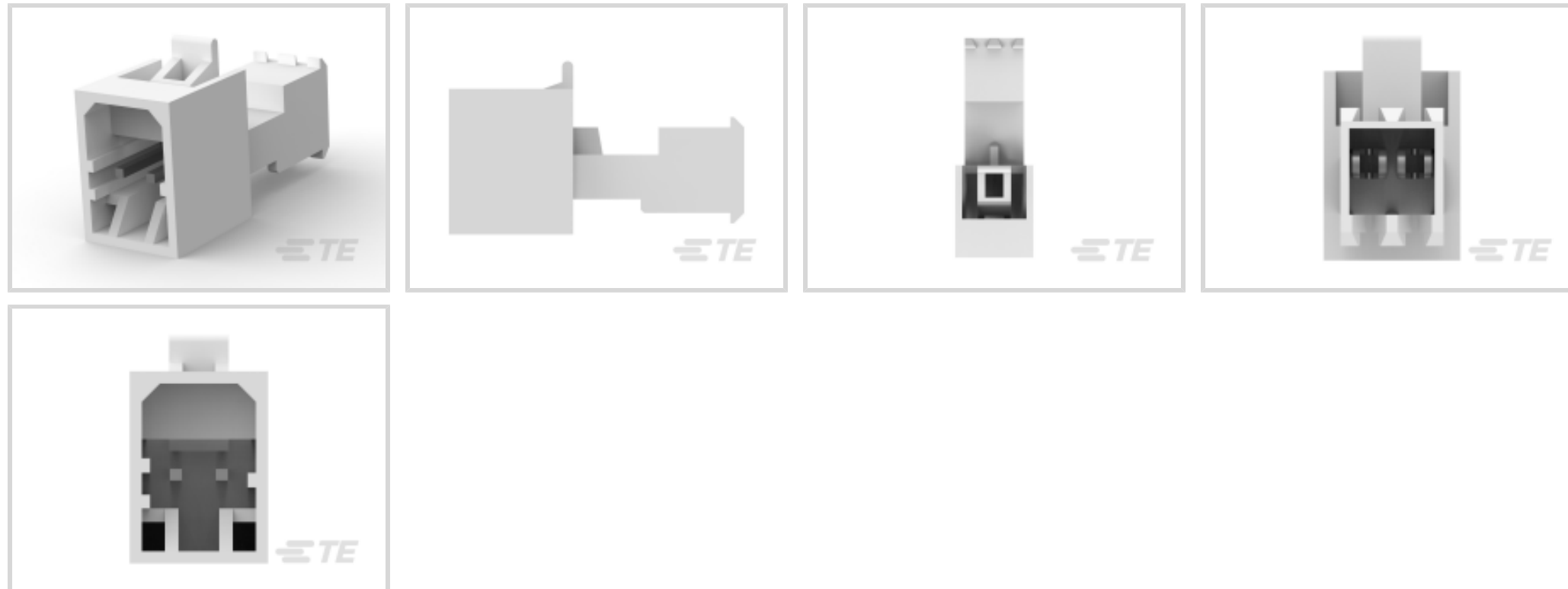

Connector Product Type: **Connector Assembly**

Connector & Housing Type: **Plug**

Mating Alignment: **With**

Mating Alignment Type: **Polarization**

Mating Retention: **With**

[All MTA Plug: Nylon, Tin Plated, 2.54 mm, with Mating Alignment \(28\)](#)

Features

Product Type Features

Compatible With Discrete Wire Type	Stranded
Connector Product Type	Connector Assembly
Connector & Housing Type	Plug
Connector System	Wire-to-Wire
Insertion Force Type	Normal
Sealable	No
Connector & Contact Terminates To	Wire & Cable

Configuration Features

Number of Cavities	2
Contacts Preloaded	Yes
Number of Positions	2
Number of Rows	1



Electrical Characteristics

Operating Voltage	250 VAC
-------------------	---------

Body Features

Primary Product Color	White
-----------------------	-------

Contact Features

Contact Underplating Material	Nickel
-------------------------------	--------

Wire Contact Termination Area Plating Material	Tin
--	-----

Contact Type	Tab
--------------	-----

Contact Mating Area Plating Material	Tin (Sn)
--------------------------------------	----------

Contact Retention Within Housing	With
----------------------------------	------

Contact Current Rating (Max)	5 A
------------------------------	-----

Termination Features

Termination Method to Wire & Cable	Insulation Displacement (IDC)
------------------------------------	-------------------------------

Mechanical Attachment

Contact Retention Type Within Housing	Locking Lance
---------------------------------------	---------------

Mating Alignment	With
------------------	------

Mating Alignment Type	Polarization
-----------------------	--------------

Mating Retention	With
------------------	------

Mating Retention Type	Latch
-----------------------	-------

Connector Mounting Type	Cable Mount (Free-Hanging)
-------------------------	----------------------------

Housing Features

Housing Material	Nylon 6/6
------------------	-----------

Centerline (Pitch)	2.54 mm [.1 in]
--------------------	-----------------

Dimensions

Connector Width	21.4 mm [.843 in]
-----------------	-------------------

Connector Height	12.54 mm [.494 in]
------------------	--------------------

Wire Size	24 AWG
-----------	--------

Connector Length	7.62 mm [.3 in]
------------------	-----------------

Usage Conditions

Operating Temperature Range	-55 – 105 °C [-67 – 221 °F]
-----------------------------	-----------------------------

Operation/Application

Shielded	No
----------	----



Circuit Application	Signal
---------------------	--------

Industry Standards

Compatible With Agency/Standards Products	CSA, UL
UL Rating	Recognized
Compatible With Approved Standards Products	UL E28476
CSA Rating	LR 7189
UL Flammability Rating	UL 94V-2

Packaging Features

Packaging Quantity	300
Packaging Method	Bag/Box

Product Compliance

[For compliance documentation, visit the product page on TE.com>](#)

EU RoHS Directive 2011/65/EU	Compliant
EU ELV Directive 2000/53/EC	Compliant
China RoHS 2 Directive MIIT Order No 32, 2016	No Restricted Materials Above Threshold
EU REACH Regulation (EC) No. 1907/2006	Current ECHA Candidate List: JUNE 2025 (250) Candidate List Declared Against: JUNE 2025 (250) Does not contain REACH SVHC
Halogen Content	Low Halogen - Br, Cl, F < 900 ppm per homogenous material. Also BFR/CFR/PVC Free
Solder Process Capability	Not applicable for solder process capability

Product Compliance Disclaimer

This information is provided based on reasonable inquiry of our suppliers and represents our current actual knowledge based on the information they provided. This information is subject to change. The part numbers that TE has identified as EU RoHS compliant have a maximum concentration of 0.1% by weight in homogenous materials for lead, hexavalent chromium, mercury, PBB, PBDE, DBP, BBP, DEHP, DIBP, and 0.01% for cadmium, or qualify for an exemption to these limits as defined in the Annexes of Directive 2011/65/EU (RoHS2). Finished electrical and electronic equipment products will be CE marked as required by Directive 2011/65/EU. Components may not be CE marked. Additionally, the part numbers that TE has identified as EU ELV compliant have a maximum concentration of 0.1% by weight in homogenous materials for lead, hexavalent chromium, and mercury, and 0.01% for cadmium, or qualify for an exemption to these limits as defined in the Annexes of Directive 2000/53/EC (ELV). Regarding the REACH Regulation, the information TE provides on SVHC in articles for this part number is based on the latest European Chemicals Agency (ECHA) 'Guidance on requirements for substances in articles' posted at this URL: <https://echa.europa.eu/guidance-documents/guidance-on-reach>

Compatible Parts



Also in the Series | **MTA 100**

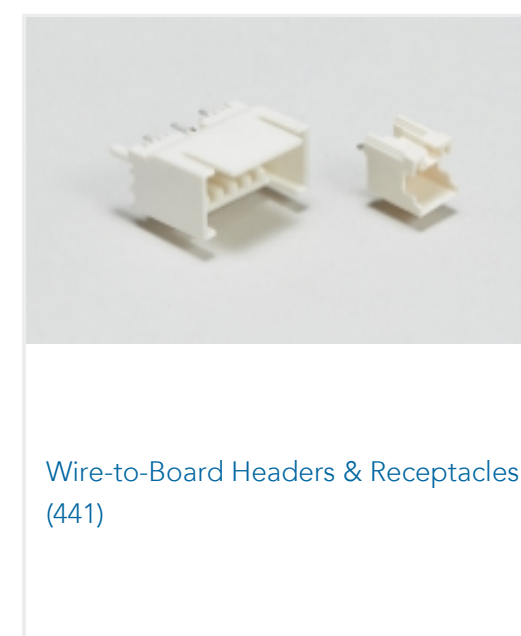
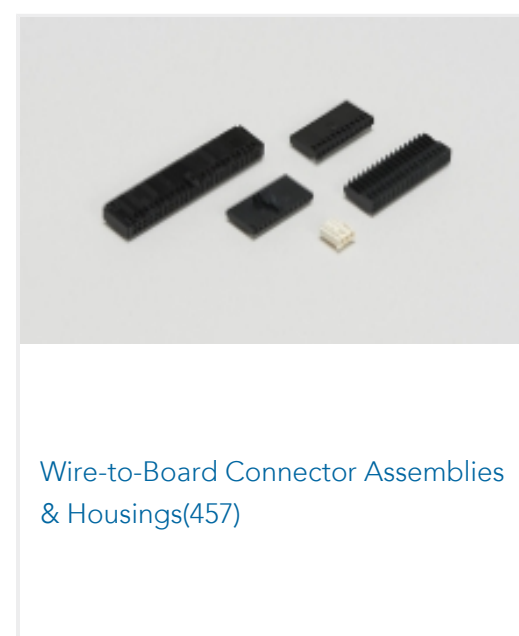
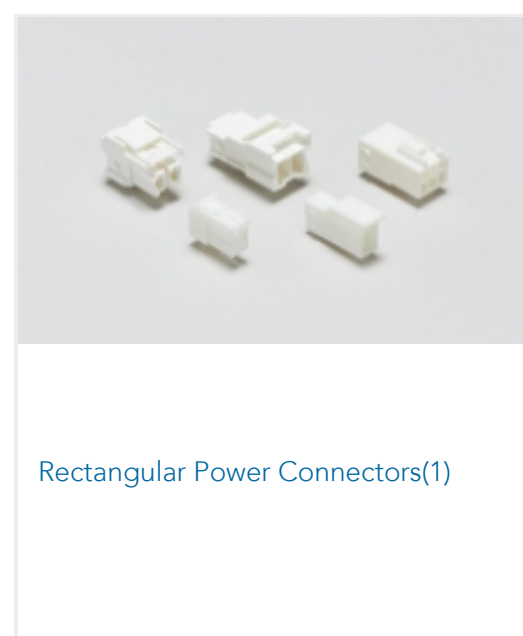
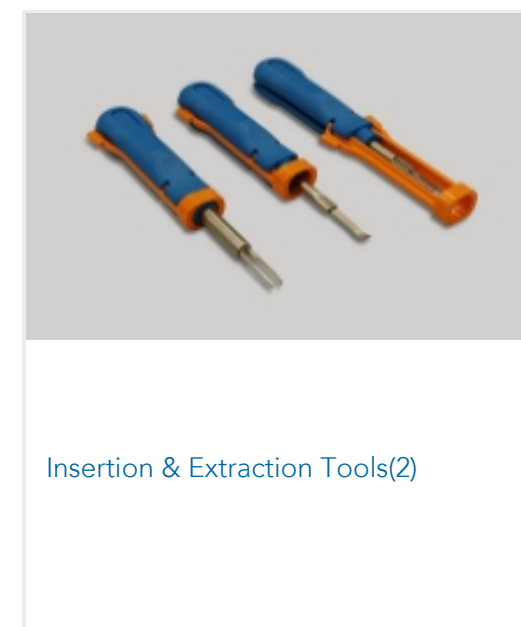
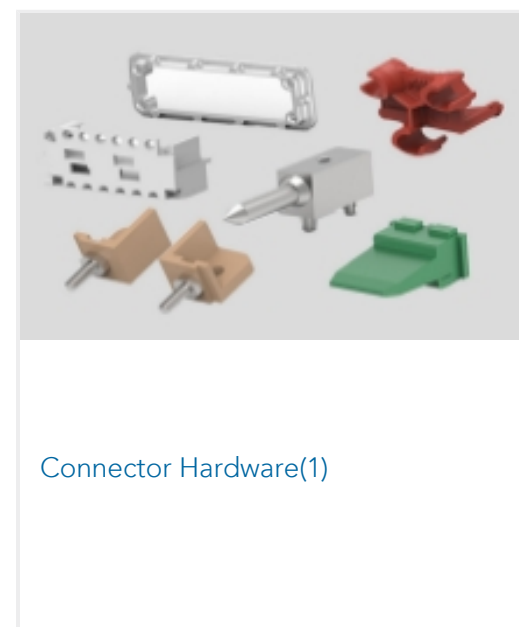
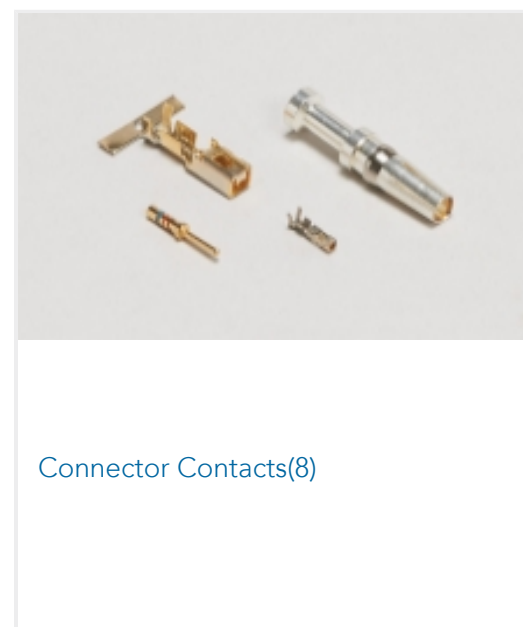
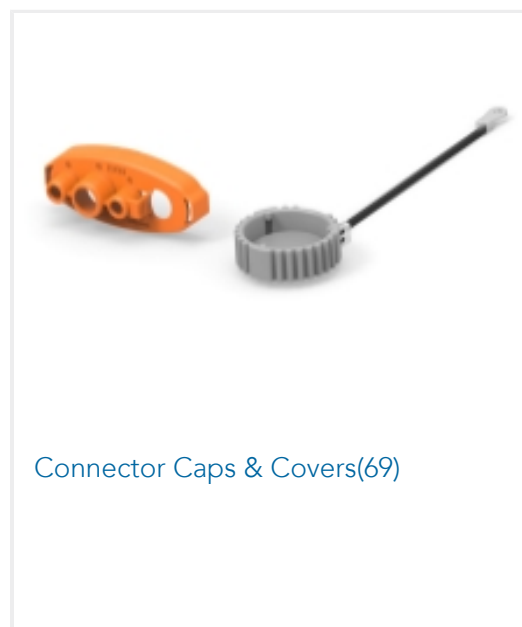

Customers Also Bought

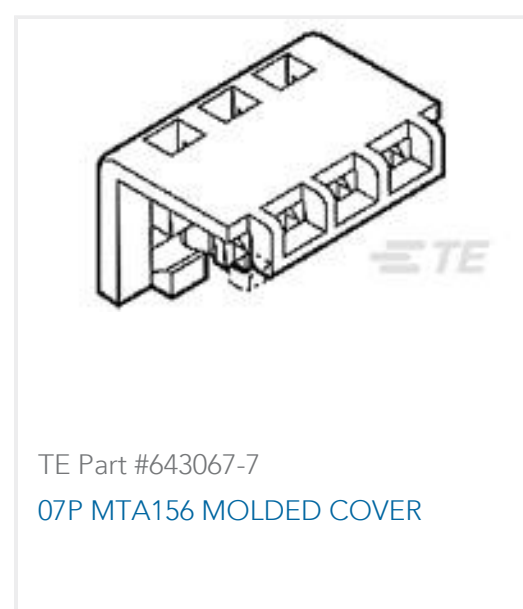



Documents

Product Drawings

[02P MTA100 PSTD CONN ASSY SN](#)

English

CAD Files

[3D PDF](#)

English

Customer View Model

[ENG_CVM_3-647001-2_E.2d_dxf.zip](#)

English

Customer View Model

[ENG_CVM_3-647001-2_E.3d_igs.zip](#)

English

Customer View Model

[ENG_CVM_3-647001-2_E.3d_stp.zip](#)

English

[3D PDF](#)

3D

Customer View Model

[ENG_CVM_CVM_3-647001-2_C.2d_dxf.zip](#)

English

Customer View Model

[ENG_CVM_CVM_3-647001-2_C.3d_igs.zip](#)

English

Customer View Model

[ENG_CVM_CVM_3-647001-2_C.3d_stp.zip](#)

English

By downloading the CAD file I accept and agree to the [Terms and Conditions](#) of use.

Product Specifications

[Application Specification](#)

English

Agency Approvals

[Agency Approval Document](#)

English

3-647001-2

2 Position, Plug, Connector Assembly, Insulation Displacement (IDC), Wire-to-Wire,
Tin (Sn), Normal, UL 94V-2, 2.54 mm [.1 in] Centerline, MTA 100

