



MTA 156

TE Internal #: 4-641437-5

15 Position, Plug, Connector Assembly, Insulation Displacement (IDC), Wire-to-Wire, Tin (Sn), UL 94V-2, 3.96 mm [.156 in] Centerline, 1 Row, MTA 156

[View on TE.com >](#)

Connectors > Rectangular Connectors > Standard Rectangular Connectors

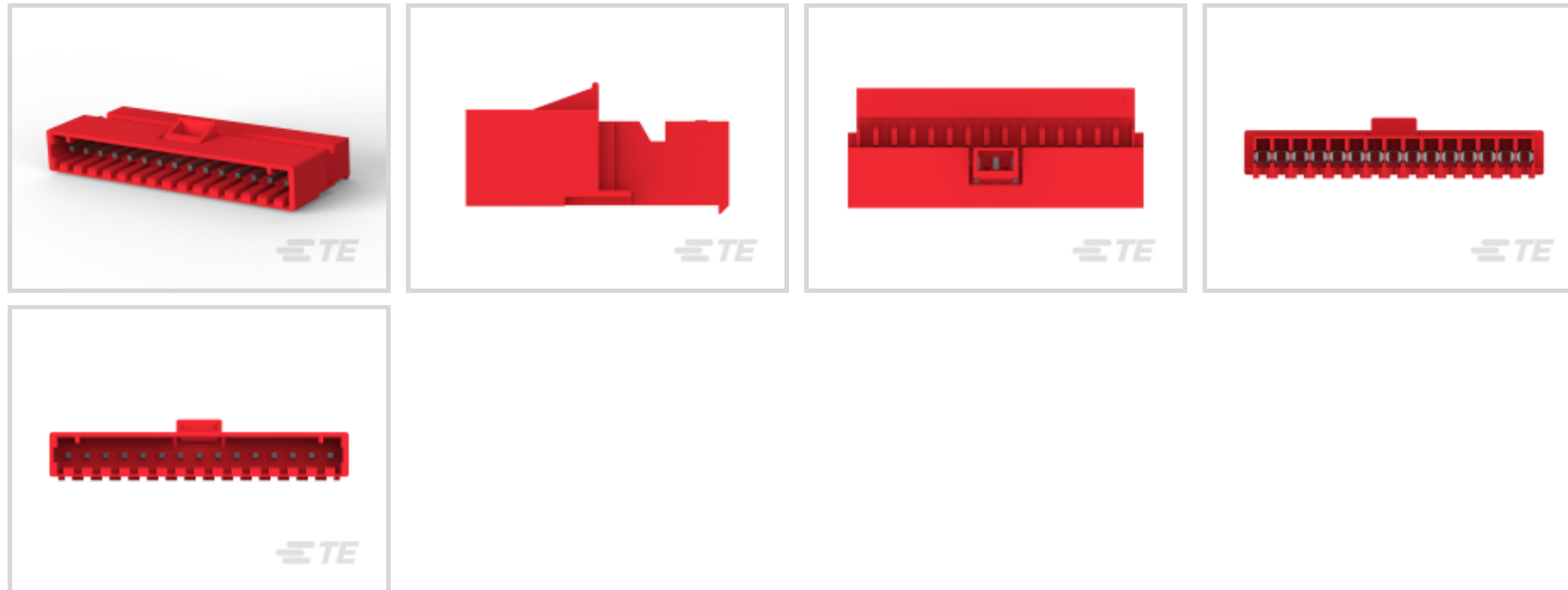

Connector Product Type: **Connector Assembly**

Connector & Housing Type: **Plug**

Mating Alignment: **With**

Mating Alignment Type: **Polarization**

Mating Retention: **With**

Features

Product Type Features

Compatible With Discrete Wire Type	Solid, Stranded
Connector Product Type	Connector Assembly
Connector & Housing Type	Plug
Connector System	Wire-to-Wire
Sealable	No
Connector & Contact Terminates To	Wire & Cable

Configuration Features

Number of Positions	15
Number of Rows	1
Number of Power Positions	15
Number of Signal Positions	0

Electrical Characteristics

Operating Voltage	600 VAC
-------------------	---------

Body Features



Primary Product Color	White
Cable Exit Angle	90°

Contact Features

Contact Underplating Material	Nickel
Contact Underplating Material Thickness	50 µm[1.27 µin]
Contact Layout	Inline
Contact Base Material	Copper Alloy
Wire Contact Termination Area Plating Thickness	2.03 µm[80 µin]
Contact Mating Area Plating Material Finish	Matte
Contact Mating Area Plating Material	Tin (Sn)
Contact Retention Within Housing	With
Contact Current Rating (Max)	7 A
Contact Type	Pin
Wire Contact Termination Area Plating Material	Tin
Contact Mating Area Plating Material Thickness	2.03 µm[80 µin]

Termination Features

Termination Method to Wire & Cable	Insulation Displacement (IDC)
------------------------------------	-------------------------------

Mechanical Attachment

Strain Relief	With
Panel Mount Feature	Without
Contact Retention Type Within Housing	Locking Lance
Mating Alignment	With
Mating Alignment Type	Polarization
Mating Retention	With
Mating Retention Type	Latch
Connector Mounting Type	Cable Mount (Free-Hanging)

Housing Features

Wire & Cable IDC Installation Type	Closed End
Centerline (Pitch)	3.96 mm[.156 in]
Housing Material	Nylon GF

Dimensions

Compatible Insulation Diameter Range	2.41 mm[.095 in]
--------------------------------------	------------------



Connector Height	12.37 mm
------------------	----------

Connector Length	63.4 mm
------------------	---------

Wire Size	.3 – .4 mm ²
-----------	-------------------------

Usage Conditions

Operating Temperature Range	-55 – 105 °C[-67 – 221 °F]
-----------------------------	----------------------------

Operation/Application

Circuit Application	Power
---------------------	-------

Industry Standards

Compatible With Agency/Standards Products	CSA, UL
---	---------

UL Rating	Recognized
-----------	------------

Compatible With Approved Standards Products	UL E28476
---	-----------

CSA Rating	Certified, LR 7189
------------	--------------------

UL Flammability Rating	UL 94V-2
------------------------	----------

Glow Wire Rating	Standard Part - Not Glow Wire
------------------	-------------------------------

Packaging Features

Packaging Quantity	500
--------------------	-----

Packaging Method	Package
------------------	---------

Product Compliance

[For compliance documentation, visit the product page on TE.com>](#)

EU RoHS Directive 2011/65/EU	Compliant
------------------------------	-----------

EU ELV Directive 2000/53/EC	Compliant
-----------------------------	-----------

China RoHS 2 Directive MIIT Order No 32, 2016	No Restricted Materials Above Threshold
---	---

EU REACH Regulation (EC) No. 1907/2006	Current ECHA Candidate List: JUNE 2025 (250) Candidate List Declared Against: JUNE 2025 (250) Does not contain REACH SVHC
--	---

Halogen Content	Low Halogen - Br, Cl, F < 900 ppm per homogenous material. Also BFR/CFR/PVC Free
-----------------	--

Solder Process Capability	Not applicable for solder process capability
---------------------------	--

Product Compliance Disclaimer

This information is provided based on reasonable inquiry of our suppliers and represents our current actual knowledge based on the information they provided. This information is subject to change. The part numbers that TE has identified as

EU RoHS compliant have a maximum concentration of 0.1% by weight in homogenous materials for lead, hexavalent chromium, mercury, PBB, PBDE, DBP, BBP, DEHP, DIBP, and 0.01% for cadmium, or qualify for an exemption to these limits as defined in the Annexes of Directive 2011/65/EU (RoHS2). Finished electrical and electronic equipment products will be CE marked as required by Directive 2011/65/EU. Components may not be CE marked. Additionally, the part numbers that TE has identified as EU ELV compliant have a maximum concentration of 0.1% by weight in homogenous materials for lead, hexavalent chromium, and mercury, and 0.01% for cadmium, or qualify for an exemption to these limits as defined in the Annexes of Directive 2000/53/EC (ELV). Regarding the REACH Regulation, the information TE provides on SVHC in articles for this part number is based on the latest European Chemicals Agency (ECHA) 'Guidance on requirements for substances in articles' posted at this URL: <https://echa.europa.eu/guidance-documents/guidance-on-reach>

Compatible Parts

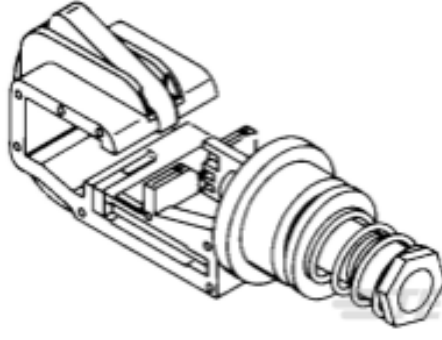

TE Part # 58082-1
MTA 156 CRIMP HEAD PRODUCTION POSTED



TE Part # 4-640426-5
15P MTA156 CONN ASSY 18AWG ORA



TE Part # 4-640428-5
15P MTA156 CONN ASSY 22AWG RED



TE Part # 4-640600-5
15P MTA156 CONN ASSY 20AWG LF



TE Part # 1-770996-5
15P SL 156 HSG W/TABS W/O LR



TE Part # 4-640427-5
15P MTA156 CONN ASSY 20AWG YEL



TE Part # 1-643067-5
15P MTA156 MOLDED COVER



TE Part # 4-640602-5
15P MTA156 CONN ASSY 24AWG LF



TE Part # 4-640599-5
15P MTA156 CONN ASSY 18AWG ORA



TE Part # 1-640551-5
15P MTA156 COVER



TE Part # 1-640643-5
15P MTA156 COVER F/T



TE Part # 1-643071-5
15P 156 CL MTA FD/TH COVER



TE Part # 4-640601-5
15P MTA156 CONN ASSY 22AWG LF



TE Part # 58074-1
MTA 50/100/156 MANUAL TOOL FRAME

Also in the Series | **MTA 156**



Connector Caps & Covers(89)

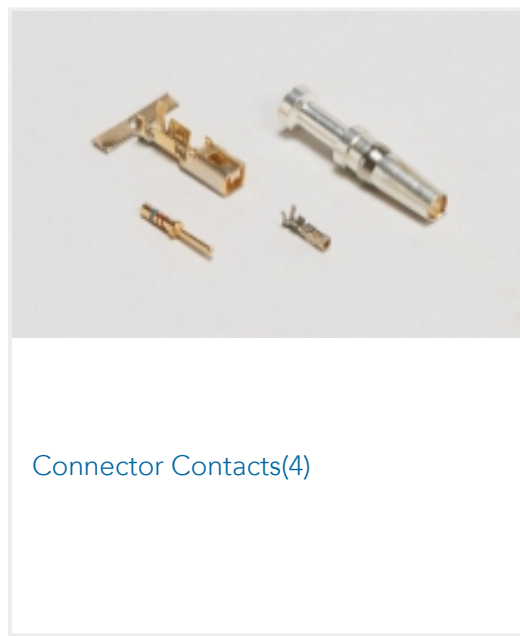

Connector Contacts(4)



Connector Hardware(2)

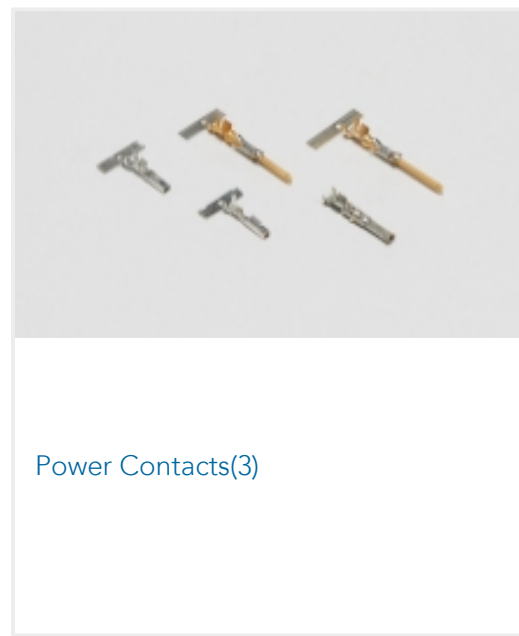

Power Contacts(3)



Rectangular Power Connectors(1178)

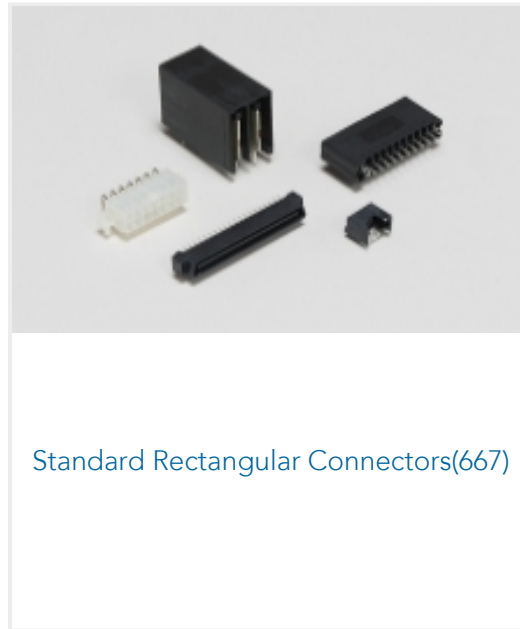

Standard Rectangular Connectors(667)

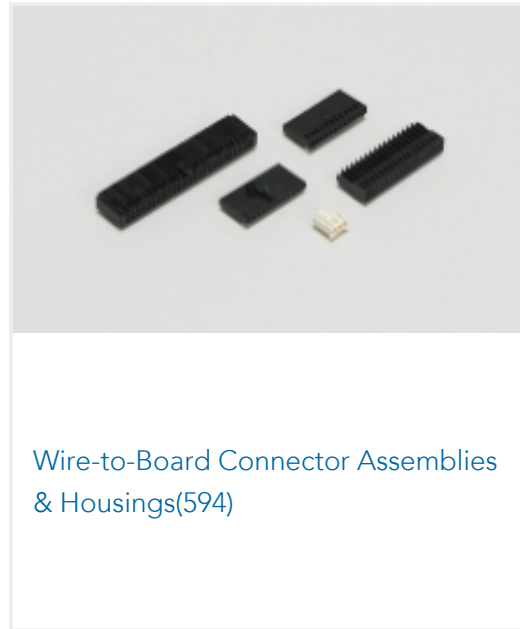

Wire-to-Board Connector Assemblies & Housings(594)

Customers Also Bought



TE Part #114017-ZZ
SEALING PLUG, SIZE 12/16, WHT

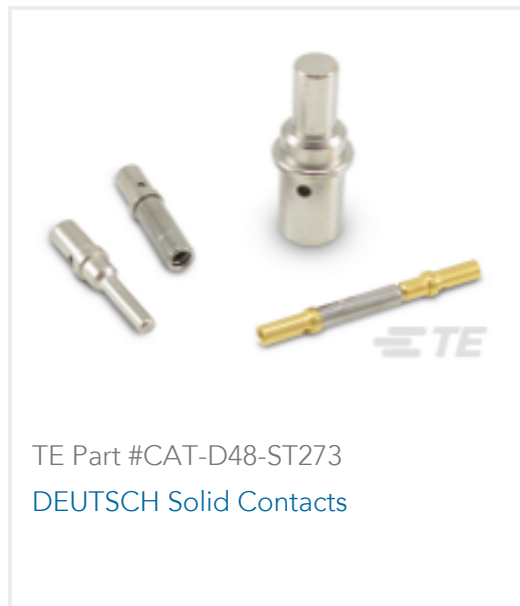

TE Part #CAT-D48-ST273
DEUTSCH Solid Contacts



TE Part #CAT-D487-W416
Wedgelocks: DEUTSCH DT



TE Part #DT06-2S
PLG, 2P, GRY, N



TE Part #DT04-2P
REC, 2P, GRY, N



TE Part #281934-2
SINGLE WIRE SEAL

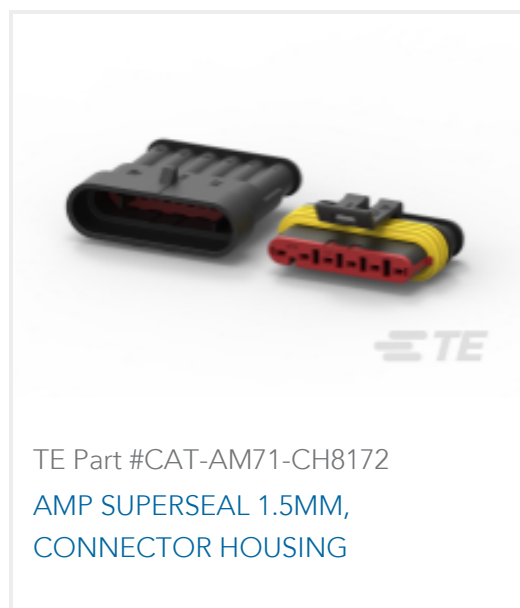

TE Part #CAT-AM71-CH8172
AMP SUPERSEAL 1.5MM,
CONNECTOR HOUSING

Documents

Product Drawings

[15P MTA156 PSTD CONN ASSY RED](#)

English

CAD Files

[3D PDF](#)

[3D](#)

[Customer View Model](#)

[ENG_CVM_CVM_4-641437-5_H.2d_dxf.zip](#)



English

Customer View Model

[ENG_CVM_CVM_4-641437-5_H.3d_igs.zip](#)

English

Customer View Model

[ENG_CVM_CVM_4-641437-5_H.3d_stp.zip](#)

English

By downloading the CAD file I accept and agree to the [Terms and Conditions](#) of use.

Product Specifications

[Application Specification](#)

English

Agency Approvals

[Agency Approval Document](#)

English