

4-643815-4 ✓ ACTIVE



MTA 100

TE Internal #: 4-643815-4

14 Position, Receptacle, Connector Assembly, Insulation

Displacement (IDC), Wire-to-Board, Tin (Sn), UL 94V-2, 2.54 mm [.1 in] Centerline, MTA 100

[View on TE.com >](#)

Connectors > Rectangular Connectors > Standard Rectangular Connectors > Nylon Tin Plated Receptacle: 2.54 mm, with Mating Alignment, MTA 100

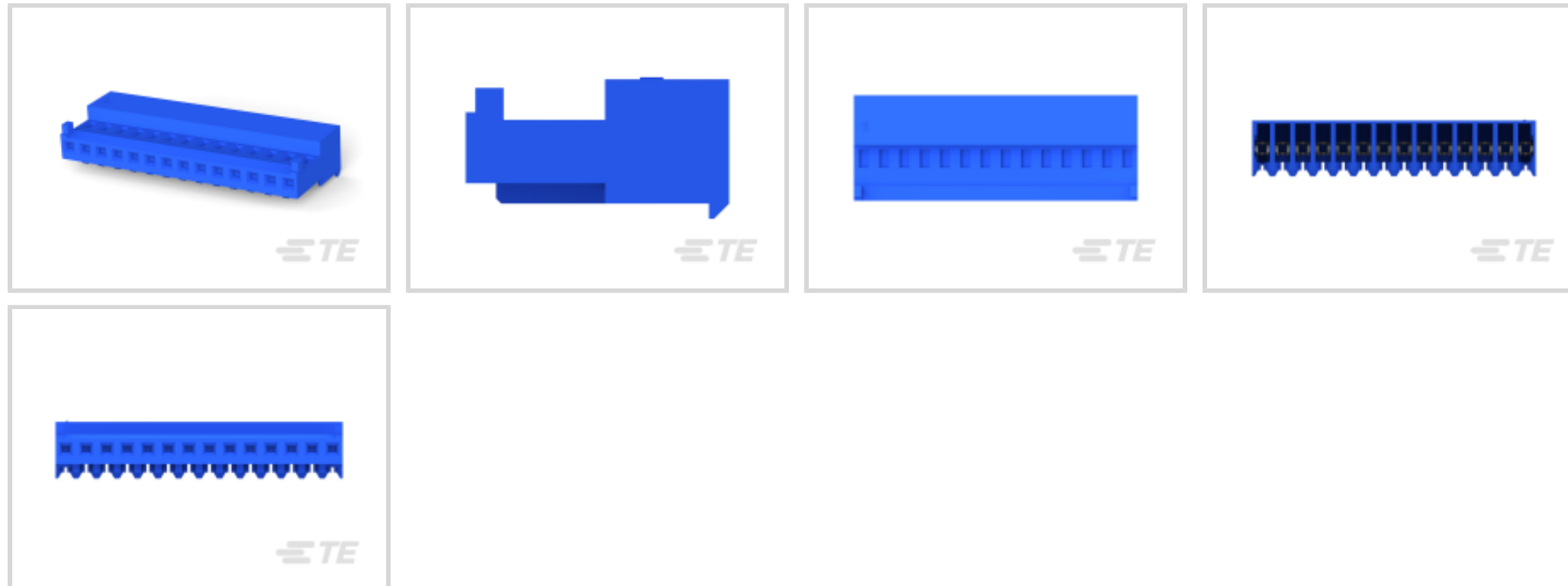

Connector Product Type: **Connector Assembly**

Mating Alignment: **With**

Mating Alignment Type: **Polarization**

Connector & Housing Type: **Receptacle**

Mating Retention Type: **Locking Ramp**

[All Nylon Tin Plated Receptacle: 2.54 mm, with Mating Alignment, MTA 100 \(127\)](#)

Features

Product Type Features

Compatible With Discrete Wire Type	Stranded
Connector Product Type	Connector Assembly
Connector & Housing Type	Receptacle
Connector System	Wire-to-Board
Sealable	No
Connector & Contact Terminates To	Wire & Cable

Configuration Features

Number of Cavities	14
Contacts Preloaded	Yes
Number of Positions	14
Number of Rows	1

Electrical Characteristics



Operating Voltage	250 VAC
-------------------	---------

Body Features

Primary Product Color	Blue
-----------------------	------

Contact Features

Contact Underplating Material	Nickel
-------------------------------	--------

Wire Contact Termination Area Plating Material	Tin
--	-----

Contact Type	Receptacle
--------------	------------

Contact Mating Area Plating Material	Tin (Sn)
--------------------------------------	----------

Contact Retention Within Housing	With
----------------------------------	------

Contact Current Rating (Max)	5 A
------------------------------	-----

Termination Features

Termination Method to Wire & Cable	Insulation Displacement (IDC)
------------------------------------	-------------------------------

Mechanical Attachment

Contact Retention Type Within Housing	Locking Lance
---------------------------------------	---------------

Mating Alignment	With
------------------	------

Mating Alignment Type	Polarization
-----------------------	--------------

Mating Retention Type	Locking Ramp
-----------------------	--------------

Mating Retention	With
------------------	------

Connector Mounting Type	Cable Mount (Free-Hanging)
-------------------------	----------------------------

Housing Features

Housing Material	Nylon
------------------	-------

Centerline (Pitch)	2.54 mm [.1 in]
--------------------	-----------------

Dimensions

Connector Width	6.99 mm [.275 in]
-----------------	-------------------

Connector Height	13.21 mm [.52 in]
------------------	-------------------

Wire Size	26 AWG
-----------	--------

Connector Length	35.56 mm [1.4 in]
------------------	-------------------

Usage Conditions

Operating Temperature Range	-55 – 105 °C [-67 – 221 °F]
-----------------------------	-----------------------------

Operation/Application

Shielded	No
----------	----

Circuit Application	Signal
---------------------	--------



Industry Standards

Compatible With Agency/Standards Products	CSA, UL
UL Rating	Recognized
Compatible With Approved Standards Products	UL E28476
CSA Rating	LR 7189
UL Flammability Rating	UL 94V-2

Packaging Features

Packaging Quantity	250
Packaging Method	Bag/Box

Product Compliance

[For compliance documentation, visit the product page on TE.com>](#)

EU RoHS Directive 2011/65/EU	Compliant
EU ELV Directive 2000/53/EC	Compliant
China RoHS 2 Directive MIIT Order No 32, 2016	No Restricted Materials Above Threshold
EU REACH Regulation (EC) No. 1907/2006	Current ECHA Candidate List: JUNE 2025 (250) Candidate List Declared Against: JUNE 2025 (250) Does not contain REACH SVHC
Halogen Content	Low Halogen - Br, Cl, F < 900 ppm per homogenous material. Also BFR/CFR/PVC Free
Solder Process Capability	Not applicable for solder process capability

Product Compliance Disclaimer

This information is provided based on reasonable inquiry of our suppliers and represents our current actual knowledge based on the information they provided. This information is subject to change. The part numbers that TE has identified as EU RoHS compliant have a maximum concentration of 0.1% by weight in homogenous materials for lead, hexavalent chromium, mercury, PBB, PBDE, DBP, BBP, DEHP, DIBP, and 0.01% for cadmium, or qualify for an exemption to these limits as defined in the Annexes of Directive 2011/65/EU (RoHS2). Finished electrical and electronic equipment products will be CE marked as required by Directive 2011/65/EU. Components may not be CE marked. Additionally, the part numbers that TE has identified as EU ELV compliant have a maximum concentration of 0.1% by weight in homogenous materials for lead, hexavalent chromium, and mercury, and 0.01% for cadmium, or qualify for an exemption to these limits as defined in the Annexes of Directive 2000/53/EC (ELV). Regarding the REACH Regulation, the information TE provides on SVHC in articles for this part number is based on the latest European Chemicals Agency (ECHA) 'Guidance on requirements for substances in articles' posted at this URL: <https://echa.europa.eu/guidance-documents/guidance-on-reach>

Compatible Parts

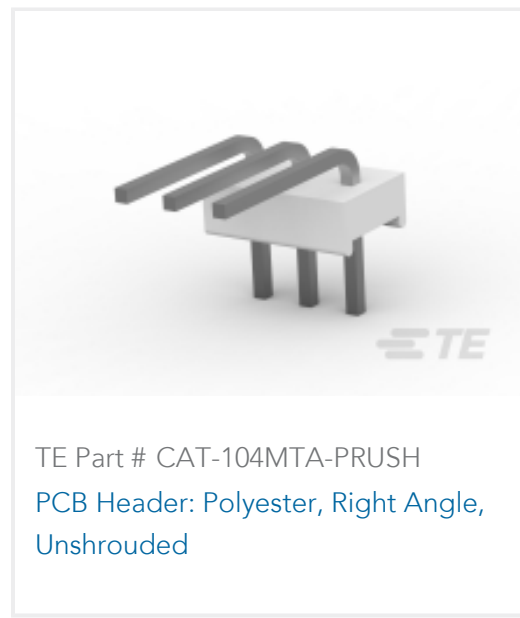

Also in the Series | **MTA 100**

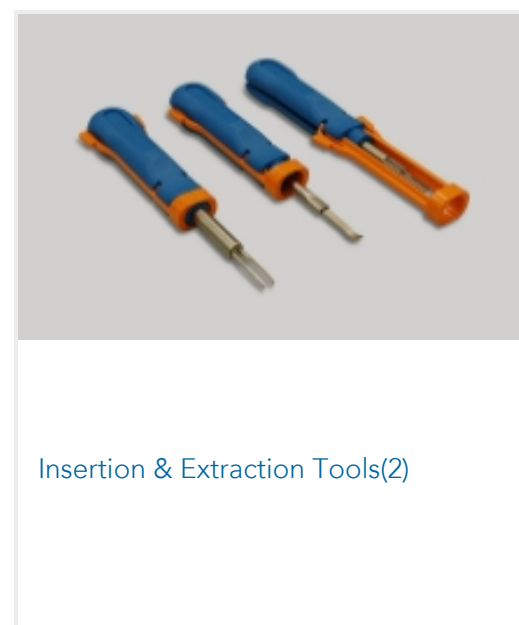
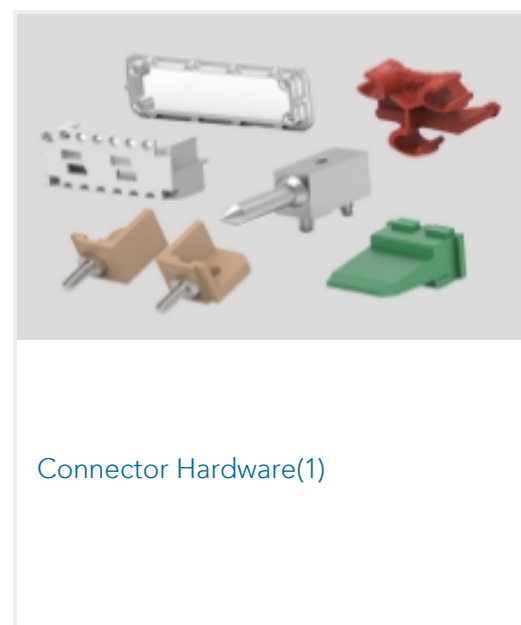
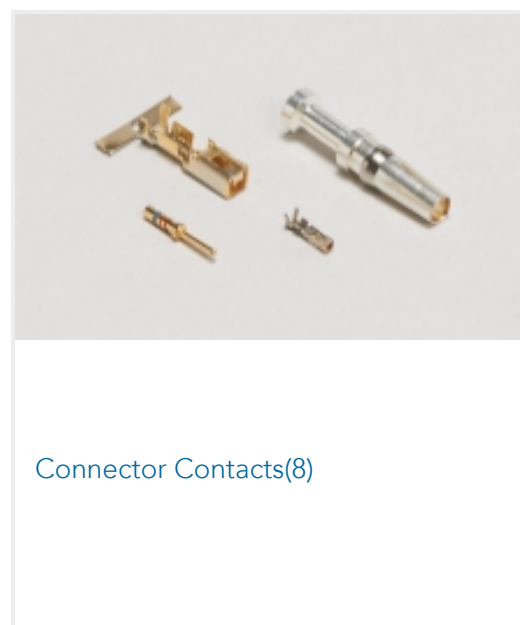

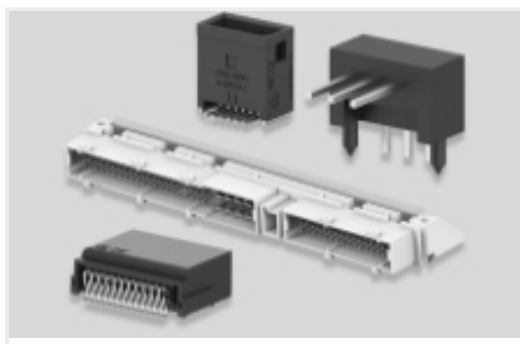

PCB Headers & Receptacles(441)



Rectangular Power Connectors(1)



Wire-to-Board Connector Assemblies & Housings(457)



Wire-to-Board Headers & Receptacles (441)

Customers Also Bought



TE Part #114017-ZZ
SEALING PLUG, SIZE 12/16, WHT



TE Part #CAT-D48-ST273
DEUTSCH Solid Contacts



TE Part #CAT-D487-W416
Wedgelocks: DEUTSCH DT



TE Part #DT06-2S
PLG, 2P, GRY, N



TE Part #DT04-2P
REC, 2P, GRY, N

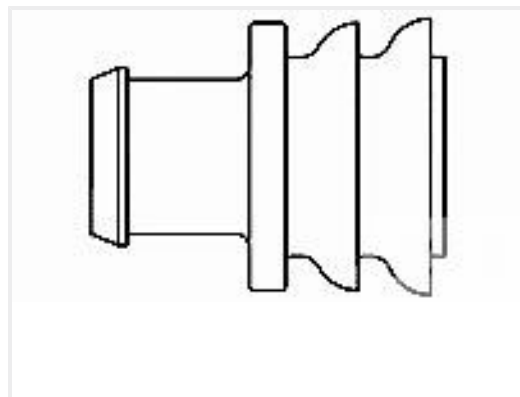

TE Part #281934-2
SINGLE WIRE SEAL



TE Part #CAT-AM71-CH8172
AMP SUPERSEAL 1.5MM,
CONNECTOR HOUSING

Documents

Product Drawings

14P MTA100 CONN ASSY POL RIB

English

CAD Files

Customer View Model

[ENG_CVM_CVM_4-643815-4_K.2d_dxf.zip](#)

English

3D PDF

3D

Customer View Model

[ENG_CVM_CVM_4-643815-4_K.3d_igs.zip](#)

English

Customer View Model

[ENG_CVM_CVM_4-643815-4_K.3d_stp.zip](#)

English

By downloading the CAD file I accept and agree to the [Terms and Conditions](#) of use.



Product Specifications

[Application Specification](#)

English

Agency Approvals

[Agency Approval Document](#)

English