

53410-1 ✓ ACTIVE



PIDG

TE Internal #: 53410-1

Closed Ring Tongue Terminal, 22 – 16 AWG, 1/4 / M6 Stud, 6.73 mm [.265 in] Stud Diameter, Closed Barrel, Straight, Tin-Lead Plating, PIDG

[View on TE.com >](#)

Terminals & Splices > Ring Terminals > PIDG Ring Tongue Terminals



Ring Terminal Product Type: Closed Ring Tongue Terminal

Wire Size: 509 – 3260 CMA

Stud Size: 1/4, M6

[All PIDG Ring Tongue Terminals \(408\)](#)

Features

Product Type Features

Ring Terminal Product Type	Closed Ring Tongue Terminal
Stud Size	1/4, M6
Sealable	No
Wire Insulation Support Retention Type	Insulation Support

Configuration Features

Number of Holes	1
-----------------	---

Body Features

Insulation Sleeve Color	Natural
Stripe Color	Red

Contact Features

Military Part Class	Class I
Barrel Type	Closed
Terminal Orientation	Straight
Terminal Plating Material	Tin-Lead

Mechanical Attachment

Wire Insulation Support	With
-------------------------	------

Dimensions

Wire Size	509 – 3260 CMA
Stud Diameter	6.73 mm [.265 in]
Tongue Thickness	.79 mm [.031 in]
Product Length	27.38 mm [1.078 in]
Compatible Insulation Diameter (Max)	3.18 mm [.125 in]
Compatible Insulation Diameter Range	2.03 – 3.18 mm [.08 – .125 in]

Usage Conditions

Insulation Option	Partially Insulated
Operating Temperature Range	0 – 150 °C [0 – 302 °F]

Operation/Application

Compatible With Wire Base Material	Copper
Compatible With Wire Plating Material	Tin

Industry Standards

Government Qualified Terminal	Yes
-------------------------------	-----

Packaging Features

Packaging Quantity	1000
Packaging Method	Loose Piece

Product Compliance

[For compliance documentation, visit the product page on TE.com>](#)

EU RoHS Directive 2011/65/EU	Not Compliant
EU ELV Directive 2000/53/EC	Compliant with Exemptions
China RoHS 2 Directive MIIT Order No 32, 2016	有害物质含量超出标准 Restricted Substance(s) Above Threshold
EU REACH Regulation (EC) No. 1907/2006	Current ECHA Candidate List: JUNE 2025 (250) Candidate List Declared Against: JUNE 2025 (250) SVHC > Threshold: Pb (13% in 4690948374)

Article Safe Usage Statements:









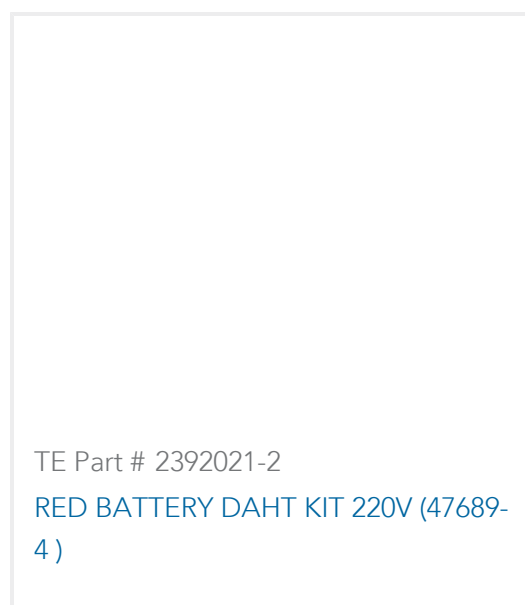

Do not eat, drink or smoke when using this product. Wash thoroughly after handling. Recycle if possible and dispose of the article by following all applicable governmental regulations relevant to your geographic location.

Halogen Content	Not Low Halogen - contains Br or Cl > 900 ppm.
Solder Process Capability	Not applicable for solder process capability

Product Compliance Disclaimer

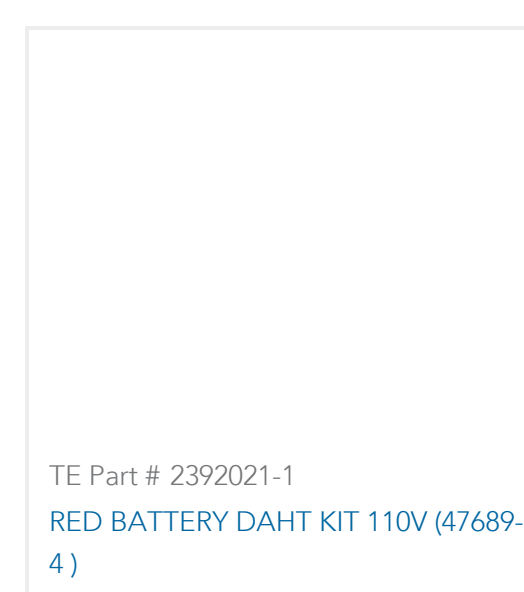
This information is provided based on reasonable inquiry of our suppliers and represents our current actual knowledge based on the information they provided. This information is subject to change. The part numbers that TE has identified as EU RoHS compliant have a maximum concentration of 0.1% by weight in homogenous materials for lead, hexavalent chromium, mercury, PBB, PBDE, DBP, BBP, DEHP, DIBP, and 0.01% for cadmium, or qualify for an exemption to these limits as defined in the Annexes of Directive 2011/65/EU (RoHS2). Finished electrical and electronic equipment products will be CE marked as required by Directive 2011/65/EU. Components may not be CE marked. Additionally, the part numbers that TE has identified as EU ELV compliant have a maximum concentration of 0.1% by weight in homogenous materials for lead, hexavalent chromium, and mercury, and 0.01% for cadmium, or qualify for an exemption to these limits as defined in the Annexes of Directive 2000/53/EC (ELV). Regarding the REACH Regulation, the information TE provides on SVHC in articles for this part number is based on the latest European Chemicals Agency (ECHA) 'Guidance on requirements for substances in articles' posted at this URL: <https://echa.europa.eu/guidance-documents/guidance-on-reach>

Compatible Parts

 <p>TE Part # 2392021-2 RED BATTERY DAHT KIT 220V (47689-4)</p>	 <p>TE Part # 47806-2 DIES PIDG 22-16 DIE SET</p>	 <p>TE Part # 132246-3 TERMINAL RING TONGUE PIDG 22 18</p>	 <p>TE Part # 47386-4 DAHT PG PIDG 26-16 ASSY</p>
 <p>TE Part # 47386 DAHT PG PIDG 26-16 ASSY</p>	 <p>TE Part # 58433-3 PRO CR ASSY, RBY IS9252</p>	 <p>TE Part # 58423-1 DIE, RBY IS9252</p>	 <p>TE Part # 2392021-1 RED BATTERY DAHT KIT 110V (47689-4)</p>
 <p>TE Part # 2063030-1 SDE DIESET, RBY, UL</p>	 <p>TE Part # 539691-2 ERGO DIE R.B.Y</p>	 <p>TE Part # 169404 CERTI-LOK DIE</p>	 <p>TE Part # 59300 T-HEAD PIDG PG 26-16 ASSY</p>



Also in the Series | PIDG

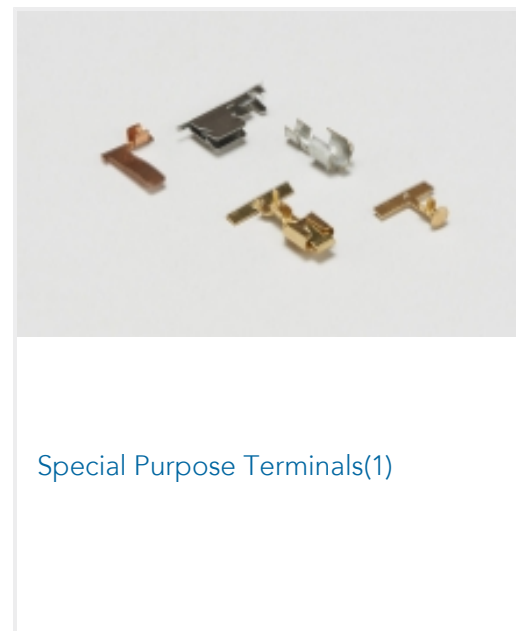
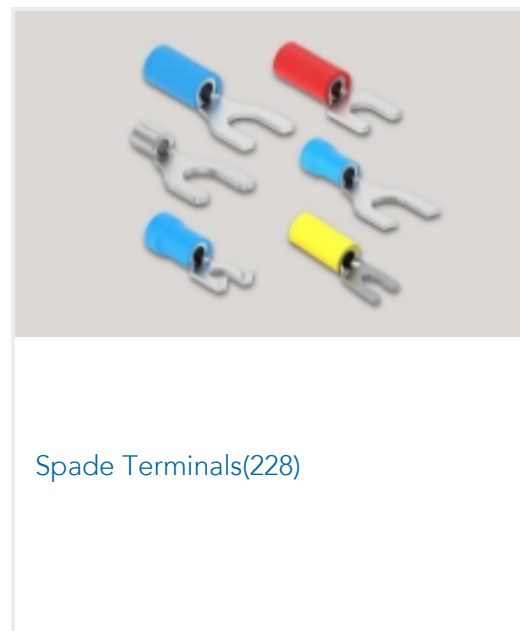
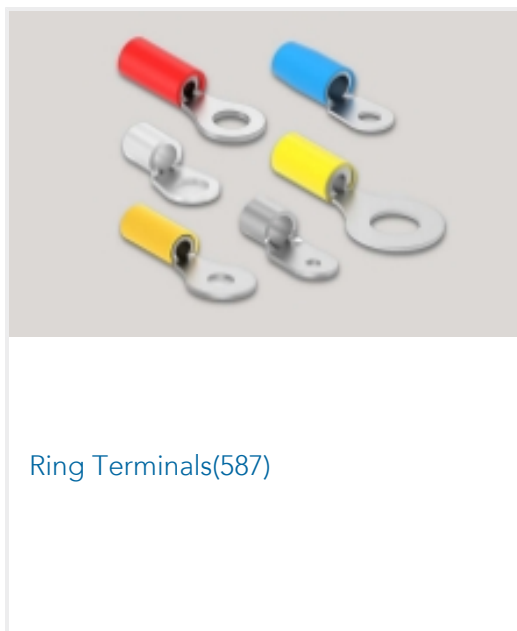
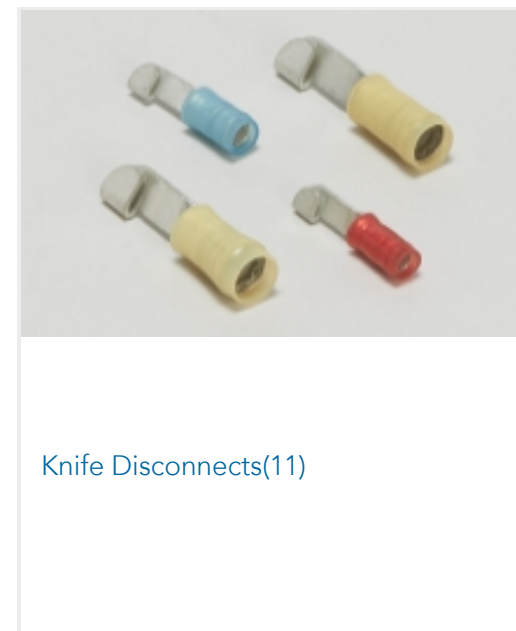
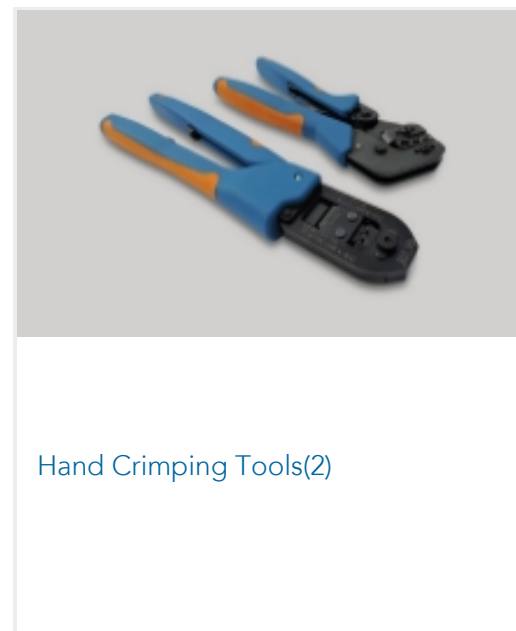
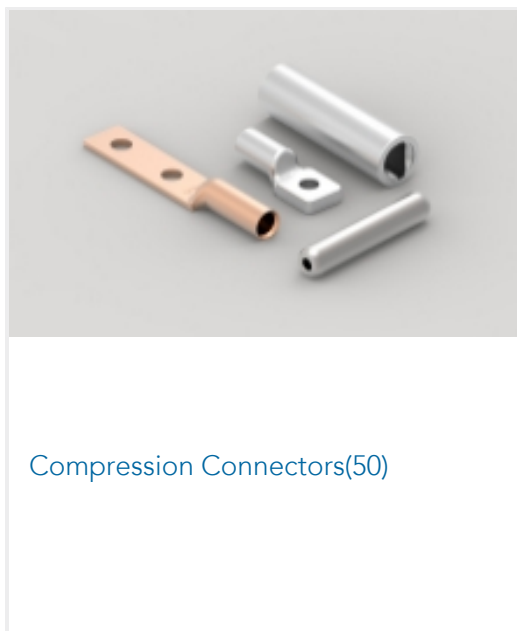

Customers Also Bought

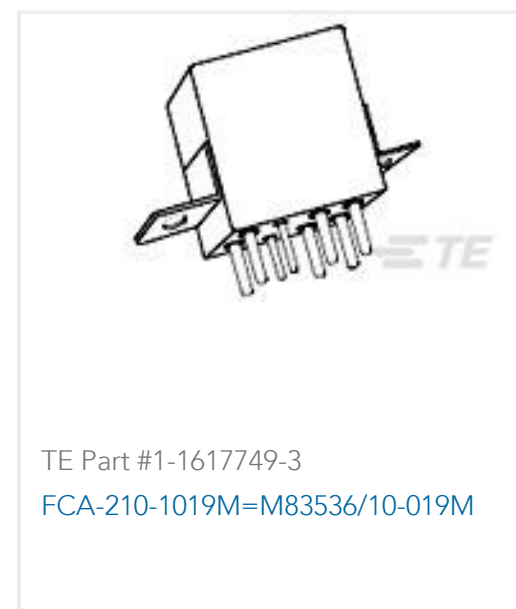
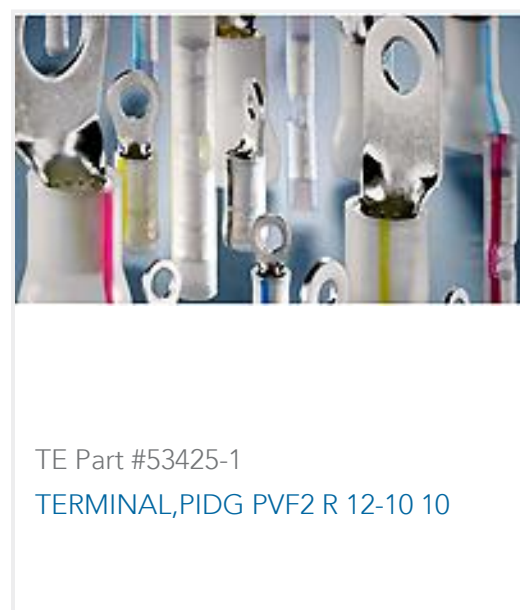



Documents

Product Drawings

[TERMINAL,PIDG PVF2 R 22-16 1/4](#)

English

CAD Files

3D PDF

3D

Customer View Model

[ENG_CVM_CVM_53410-1_N.2d_dxf.zip](#)

English

Customer View Model

[ENG_CVM_CVM_53410-1_N.3d_igs.zip](#)

English

Customer View Model

[ENG_CVM_CVM_53410-1_N.3d_stp.zip](#)

English

Customer View Model

[ENG_CVM_53410-1_P.3d_igs.zip](#)

English

Customer View Model

[ENG_CVM_53410-1_P.3d_stp.zip](#)

English

Customer View Model

[ENG_CVM_53410-1_P.2d_dxf.zip](#)

English

3D PDF

English

By downloading the CAD file I accept and agree to the [Terms and Conditions](#) of use.

Product Specifications

[Application Specification](#)

English