

53547-1 ✓ ACTIVE

PIDG

TE Internal #: 53547-1

Butt Splice, 24 – 20 AWG, .2 – .6 mm² Wire, 320 – 1290 CMA, Fully Insulated, Serrated, Copper, 26.29 mm [1.035 in] Length, Loose Piece, PIDG

[View on TE.com >](#)



Terminals & Splices > Splices > PIDG Butt Splices



Splice Type: **Butt Splice**

Wire Size: **.2 – .6 mm²**

Sealable: **No**

Splice Features: **Serrated**

[All PIDG Butt Splices \(25\)](#)

Features

Product Type Features

Splice Type	Butt Splice
Sealable	No
Compatible With Discrete Wire Type	Stranded
Wire Insulation Support Retention Type	Insulation Support

Configuration Features

Compatible With Wire & Cable Type	Discrete Wire
-----------------------------------	---------------

Body Features

Insulation Material	PVF2
Insulation Support Sleeve Material	Copper
Splice Features	Serrated

Contact Features

Military Part Class	Class I
Terminal Plating Material	Tin-Lead



Contact Base Material	Copper
-----------------------	--------

Barrel Type	Closed
-------------	--------

Mechanical Attachment

Wire Insulation Support	With
-------------------------	------

Dimensions

Wire Size	320 – 1290 CMA
-----------	----------------

Compatible Insulation Diameter Range	2.54 mm[.1 in]
--------------------------------------	----------------

Barrel Inside Diameter	1.09 mm[.043 in]
------------------------	------------------

Product Length	26.29 mm[1.035 in]
----------------	--------------------

Usage Conditions

Insulation Option	Fully Insulated
-------------------	-----------------

Industry Standards

Government Qualified Splice	Yes
-----------------------------	-----

Packaging Features

Packaging Quantity	1000
--------------------	------

Packaging Method	Loose Piece
------------------	-------------

Product Compliance

[For compliance documentation, visit the product page on TE.com>](#)

EU RoHS Directive 2011/65/EU	Not Compliant
------------------------------	---------------

EU ELV Directive 2000/53/EC	Compliant with Exemptions
-----------------------------	---------------------------

China RoHS 2 Directive MIIT Order No 32, 2016	有害物质含量超出标准 Restricted Substance(s) Above Threshold
---	--

EU REACH Regulation (EC) No. 1907/2006	Current ECHA Candidate List: JUNE 2025 (250) Candidate List Declared Against: JUNE 2025 (250) SVHC > Threshold: Pb (13% in 4690948374)
--	---

Article Safe Usage Statements:

Do not eat, drink or smoke when using this product. Wash thoroughly after handling. Recycle if possible and dispose of the article by following all applicable governmental regulations relevant to your geographic location.

Halogen Content	Not Low Halogen - contains Br or Cl > 900 ppm.
-----------------	--

Solder Process Capability	Not applicable for solder process capability
---------------------------	--

Product Compliance Disclaimer

This information is provided based on reasonable inquiry of our suppliers and represents our current actual knowledge based on the information they provided. This information is subject to change. The part numbers that TE has identified as EU RoHS compliant have a maximum concentration of 0.1% by weight in homogenous materials for lead, hexavalent chromium, mercury, PBB, PBDE, DBP, BBP, DEHP, DIBP, and 0.01% for cadmium, or qualify for an exemption to these limits as defined in the Annexes of Directive 2011/65/EU (RoHS2). Finished electrical and electronic equipment products will be CE marked as required by Directive 2011/65/EU. Components may not be CE marked. Additionally, the part numbers that TE has identified as EU ELV compliant have a maximum concentration of 0.1% by weight in homogenous materials for lead, hexavalent chromium, and mercury, and 0.01% for cadmium, or qualify for an exemption to these limits as defined in the Annexes of Directive 2000/53/EC (ELV). Regarding the REACH Regulation, the information TE provides on SVHC in articles for this part number is based on the latest European Chemicals Agency (ECHA) 'Guidance on requirements for substances in articles' posted at this URL: <https://echa.europa.eu/guidance-documents/guidance-on-reach>

Compatible Parts



Also in the Series | PIDG

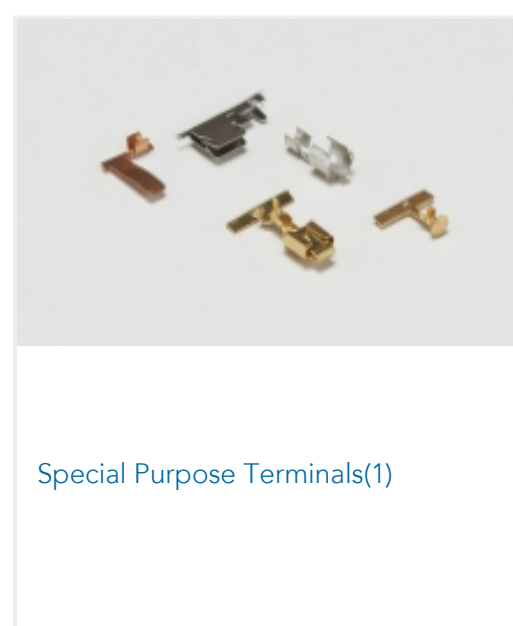
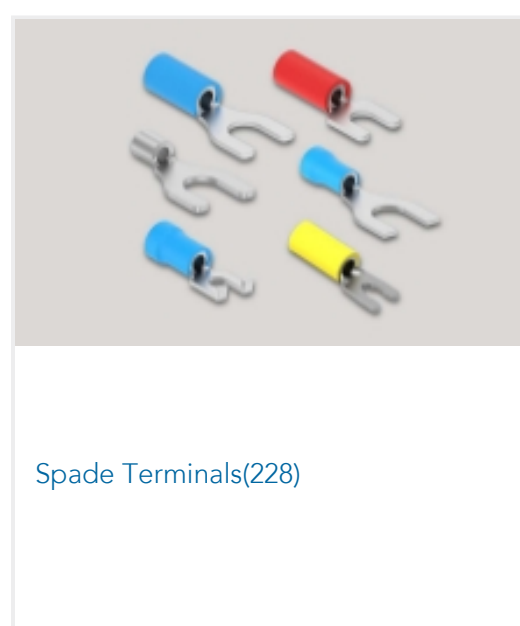
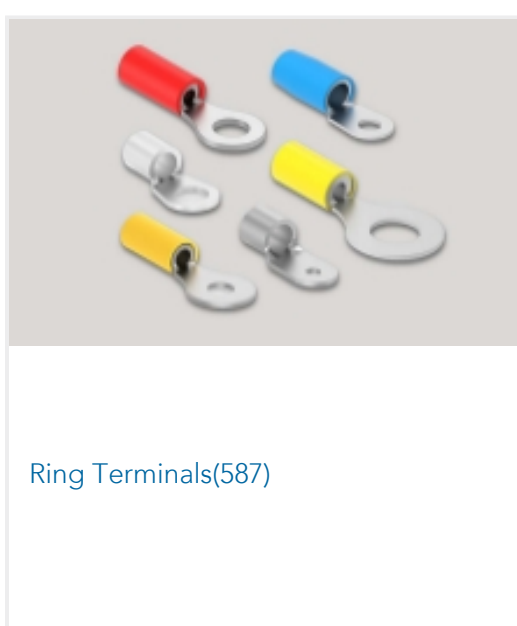
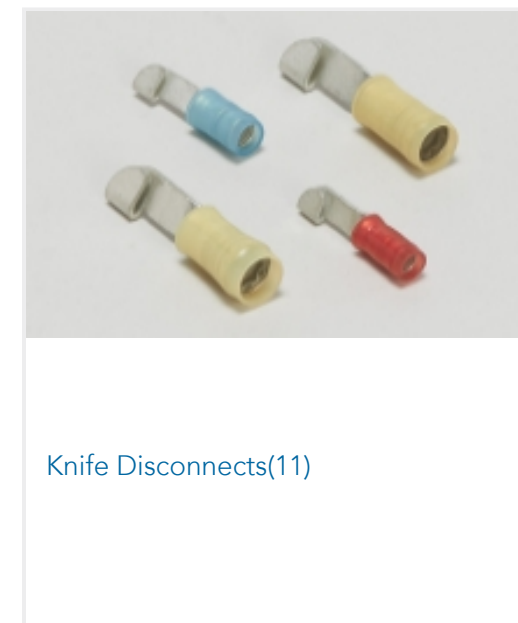
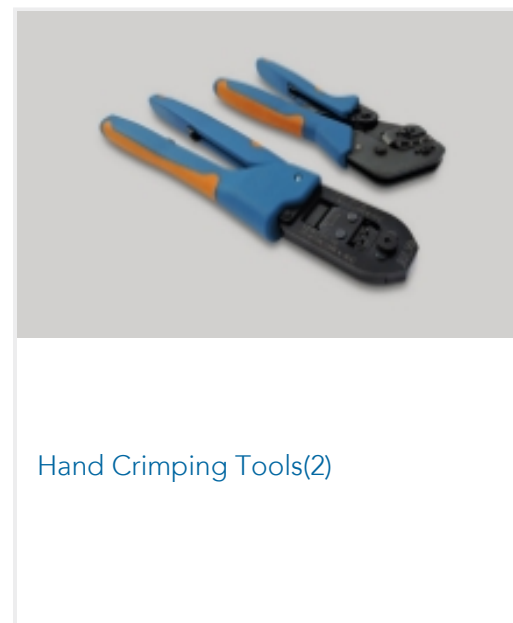
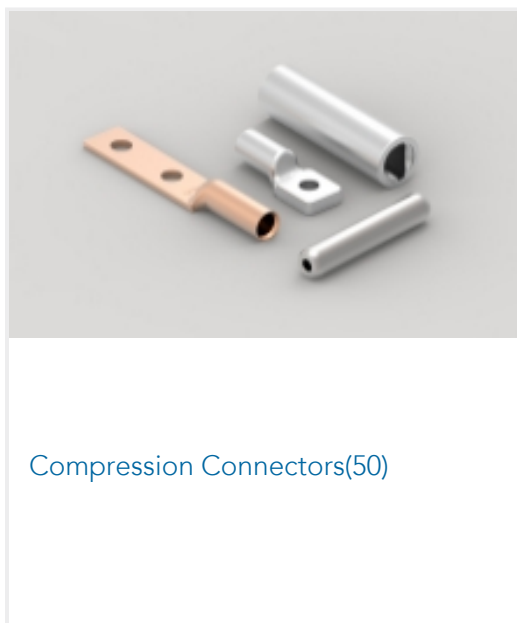

Customers Also Bought



TE Part #0662-207-1282
CONT SOC ASSY

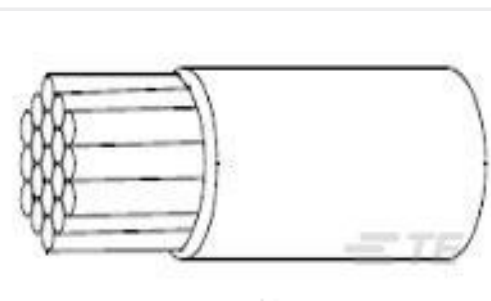

TE Part #216115-001
22759/32-16-9



TE Part #CAT-T3437-R819
RPS Commercial Grade Sleeves



TE Part #53964-1
TERMINAL,PIDG PVF2 R 16-14HD 6



TE Part #4-1393211-4
T92P11A22-240



TE Part #1-1393249-1
W58-XB1A4A-2=W58



TE Part #5207719-1
KIT SCREWLOCK FEMALE

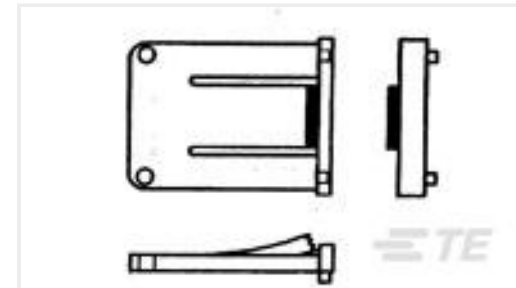

TE Part #2-1437601-7
PICOP=END PLATE PAIR SWITCH



TE Part #741107-000
207W613-100/184-0-CS5657

Documents

Product Drawings

[SPLICE BUTT PVF2 PIDG 24-20](#)

English

CAD Files

[3D PDF](#)

3D

Customer View Model

[ENG_CVM_CVM_53547-1_R.2d_dxf.zip](#)

English

Customer View Model

[ENG_CVM_CVM_53547-1_R.3d_igs.zip](#)

English

Customer View Model

[ENG_CVM_CVM_53547-1_R.3d_stp.zip](#)

English

By downloading the CAD file I accept and agree to the [Terms and Conditions](#) of use.

Product Specifications



Application Specification

English