

640251-3 ✓ ACTIVE

SL-156

TE Internal #: 640251-3

3 Position, Receptacle, Housing, Crimp, Wire-to-Board, UL 94V-0,  
3.96 mm [.156 in] Centerline, 1 Row, 250 VAC, Wire & Cable, Power  
& Signal, SL-156

[View on TE.com >](#)



Connectors > Rectangular Connectors > Standard Rectangular Connectors > Receptacle Housing: Wire-to-Board, no Mating Alignment, SL 156



Connector Product Type: **Housing**

Connector & Housing Type: **Receptacle**

Connector System: **Wire-to-Board**

Contact Retention Within Housing: **Without**

UL Flammability Rating: **UL 94V-0**

[All Receptacle Housing: Wire-to-Board, no Mating Alignment, SL 156 \(27\)](#)

## Features

### Product Type Features

Connector Product Type	Housing
Connector & Housing Type	Receptacle
Connector System	Wire-to-Board
Sealable	No
Connector & Contact Terminates To	Wire & Cable

### Configuration Features

Number of Positions	3
Number of Rows	1

### Electrical Characteristics

Operating Voltage	250 VAC
-------------------	---------

### Body Features

Primary Product Color	Natural
-----------------------	---------



### Contact Features

Contact Retention Within Housing	Without
Contact Type	Socket
Contact Current Rating (Max)	6.5 A

### Termination Features

Termination Method to Wire & Cable	Crimp
------------------------------------	-------

### Mechanical Attachment

Strain Relief	Without
Panel Mount Feature	Without
Mating Retention	Without
Connector Mounting Type	Cable Mount (Free-Hanging)

### Housing Features

Housing Entry Configuration	Left End Open
Centerline (Pitch)	3.96 mm [.156 in]
Housing Material	Nylon GF

### Dimensions

	.465 in
Connector Height	6.35 mm
Wire Size	.0509 – .823 mm <sup>2</sup>

### Usage Conditions

Operating Temperature Range	-55 – 105 °C [-67 – 221 °F]
-----------------------------	-----------------------------

### Operation/Application

Circuit Application	Power & Signal
---------------------	----------------

### Industry Standards

Compatible With Agency/Standards Products	CSA, UL
UL Flammability Rating	UL 94V-0

### Packaging Features

Packaging Quantity	500
Packaging Method	Package

### Product Compliance

[For compliance documentation, visit the product page on TE.com>](#)

EU RoHS Directive 2011/65/EU	Compliant
EU ELV Directive 2000/53/EC	Compliant
China RoHS 2 Directive MIIT Order No 32, 2016	有害物质含量符合标准要求 No Restricted Substance(s) Above Threshold
EU REACH Regulation (EC) No. 1907/2006	Current ECHA Candidate List: JUNE 2025 (250) Candidate List Declared Against: JUNE 2025 (250) Does not contain REACH SVHC
Halogen Content	Low Halogen - Br, Cl, F < 900 ppm per homogenous material. Also BFR/CFR/PVC Free
Solder Process Capability	Not applicable for solder process capability

#### Product Compliance Disclaimer

This information is provided based on reasonable inquiry of our suppliers and represents our current actual knowledge based on the information they provided. This information is subject to change. The part numbers that TE has identified as EU RoHS compliant have a maximum concentration of 0.1% by weight in homogenous materials for lead, hexavalent chromium, mercury, PBB, PBDE, DBP, BBP, DEHP, DIBP, and 0.01% for cadmium, or qualify for an exemption to these limits as defined in the Annexes of Directive 2011/65/EU (RoHS2). Finished electrical and electronic equipment products will be CE marked as required by Directive 2011/65/EU. Components may not be CE marked. Additionally, the part numbers that TE has identified as EU ELV compliant have a maximum concentration of 0.1% by weight in homogenous materials for lead, hexavalent chromium, and mercury, and 0.01% for cadmium, or qualify for an exemption to these limits as defined in the Annexes of Directive 2000/53/EC (ELV). Regarding the REACH Regulation, the information TE provides on SVHC in articles for this part number is based on the latest European Chemicals Agency (ECHA) 'Guidance on requirements for substances in articles' posted at this URL: <https://echa.europa.eu/guidance-documents/guidance-on-reach>

## Compatible Parts





Also in the Series | **SL-156**

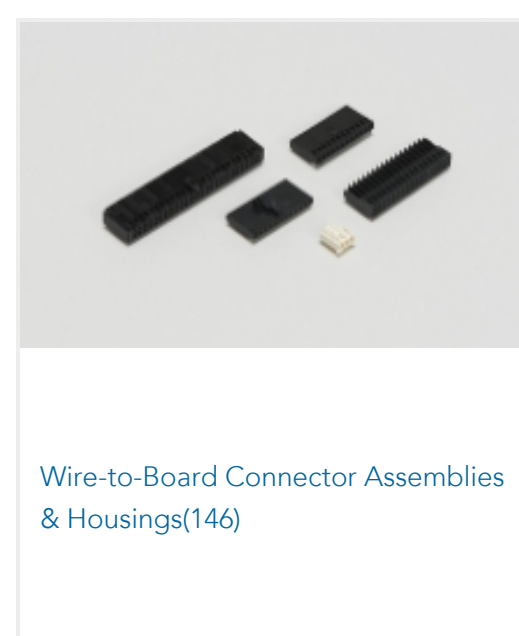
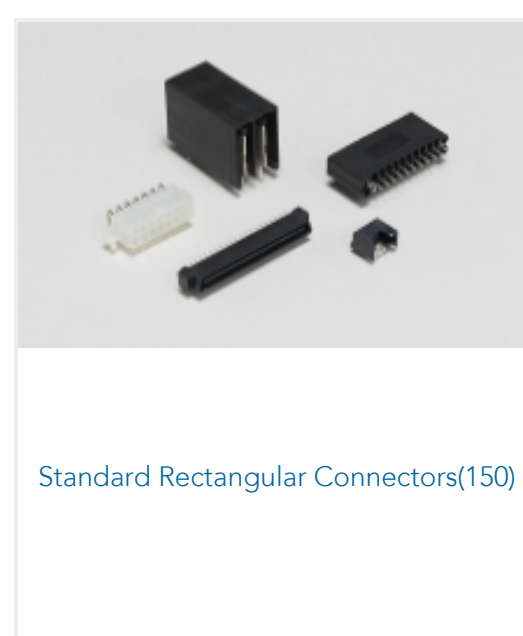
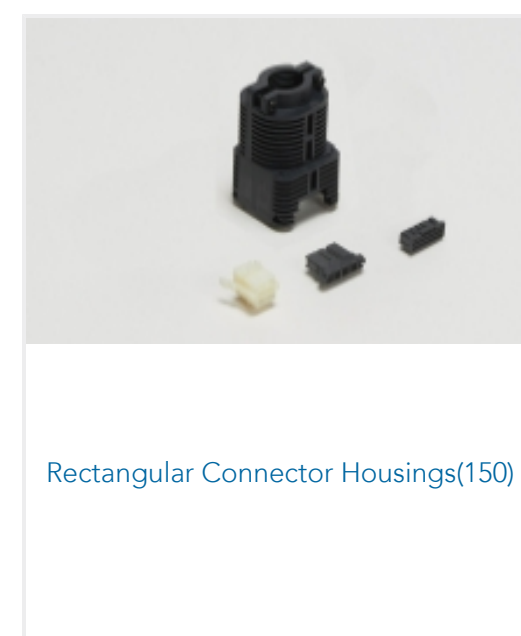
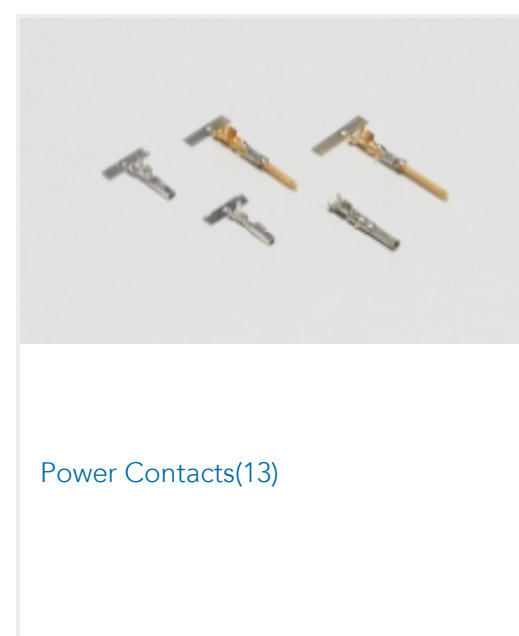
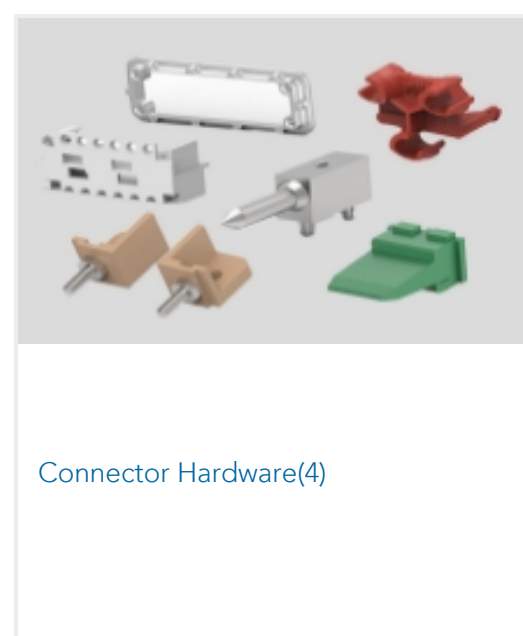
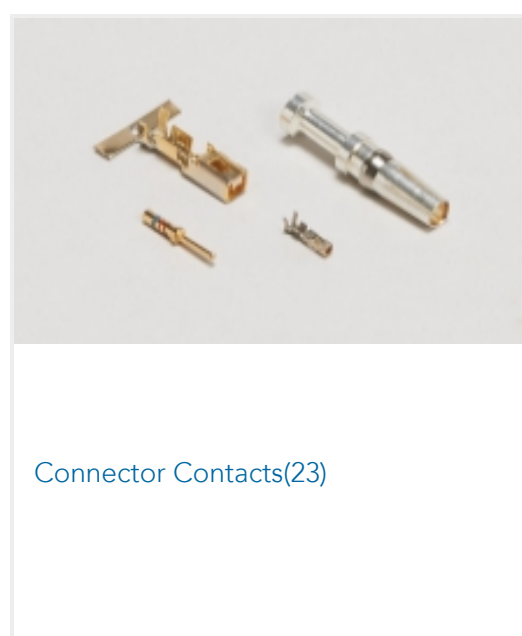

Customers Also Bought

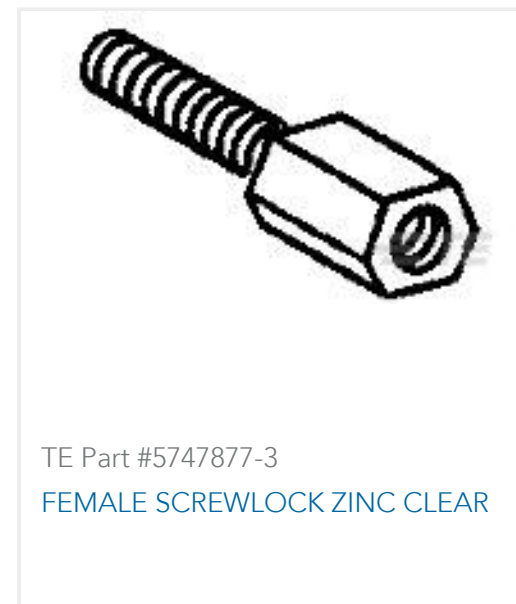
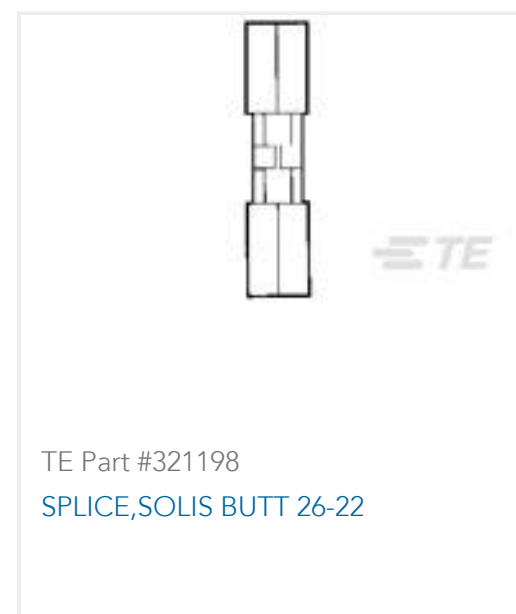
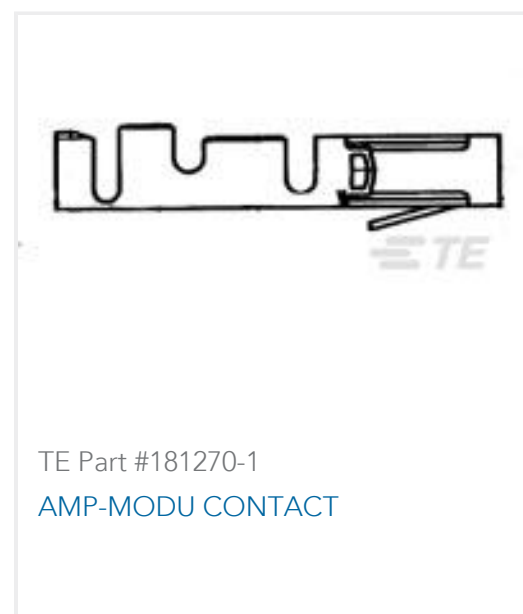

## Documents

### CAD Files

#### 3D PDF

3D

#### Customer View Model

[ENG\\_CVM\\_CVM\\_640251-3\\_AL\\_c-640251-3-al.2d\\_dxf.zip](#)

English

#### Customer View Model

[ENG\\_CVM\\_CVM\\_640251-3\\_AL\\_c-640251-3-al.3d\\_igs.zip](#)

English

#### Customer View Model

[ENG\\_CVM\\_CVM\\_640251-3\\_AL\\_c-640251-3-al.3d\\_stp.zip](#)

English

By downloading the CAD file I accept and agree to the [Terms and Conditions](#) of use.

### Product Specifications

#### Application Specification

English

### Agency Approvals



[UL Report](#)

English