



Connectors > Connector Accessories > Connector Caps & Covers



Connector Cover Type: **Strain Relief Cover**

Primary Product Color: **Natural**

Primary Product Material: **Polyester**

Number of Positions: **5**

Operating Temperature (Max): **105 °C [221 °F]**

Features

Product Type Features

| | |
|----------------------|---------------------|
| Product Profile | Standard |
| Connector Cover Type | Strain Relief Cover |

Configuration Features

| | |
|---------------------|---|
| Number of Positions | 5 |
|---------------------|---|

Body Features

| | |
|--------------------------|-----------|
| Primary Product Color | Natural |
| Primary Product Material | Polyester |

Mechanical Attachment

| | |
|---------------|------|
| Strain Relief | With |
|---------------|------|

Housing Features

| | |
|--------------------|-------------------|
| Centerline (Pitch) | 3.96 mm [.156 in] |
|--------------------|-------------------|

Usage Conditions

| | |
|---|-----------------|
| Compatible With IDC Installation Type Connector | Feed Thru |
| Operating Temperature (Max) | 105 °C [221 °F] |

| | |
|-----------------------------|----------------------------|
| Operating Temperature Range | -55 – 105 °C[-67 – 221 °F] |
|-----------------------------|----------------------------|

Industry Standards

| | |
|------------------------|----------|
| UL Flammability Rating | UL 94V-0 |
|------------------------|----------|

Product Compliance

[For compliance documentation, visit the product page on TE.com>](#)

| | |
|---|---|
| EU RoHS Directive 2011/65/EU | Compliant |
| EU ELV Directive 2000/53/EC | Compliant |
| China RoHS 2 Directive MIIT Order No 32, 2016 | No Restricted Materials Above Threshold |
| EU REACH Regulation (EC) No. 1907/2006 | Current ECHA Candidate List: JUNE 2025 (250) Candidate List Declared Against: JUNE 2025 (250) Does not contain REACH SVHC |
| Halogen Content | Not Low Halogen - contains Br or Cl > 900 ppm. |
| Solder Process Capability | Not applicable for solder process capability |

Product Compliance Disclaimer

This information is provided based on reasonable inquiry of our suppliers and represents our current actual knowledge based on the information they provided. This information is subject to change. The part numbers that TE has identified as EU RoHS compliant have a maximum concentration of 0.1% by weight in homogenous materials for lead, hexavalent chromium, mercury, PBB, PBDE, DBP, BBP, DEHP, DIBP, and 0.01% for cadmium, or qualify for an exemption to these limits as defined in the Annexes of Directive 2011/65/EU (RoHS2). Finished electrical and electronic equipment products will be CE marked as required by Directive 2011/65/EU. Components may not be CE marked. Additionally, the part numbers that TE has identified as EU ELV compliant have a maximum concentration of 0.1% by weight in homogenous materials for lead, hexavalent chromium, and mercury, and 0.01% for cadmium, or qualify for an exemption to these limits as defined in the Annexes of Directive 2000/53/EC (ELV). Regarding the REACH Regulation, the information TE provides on SVHC in articles for this part number is based on the latest European Chemicals Agency (ECHA) 'Guidance on requirements for substances in articles' posted at this URL: <https://echa.europa.eu/guidance-documents/guidance-on-reach>

Compatible Parts





Also in the Series | **MTA 156**

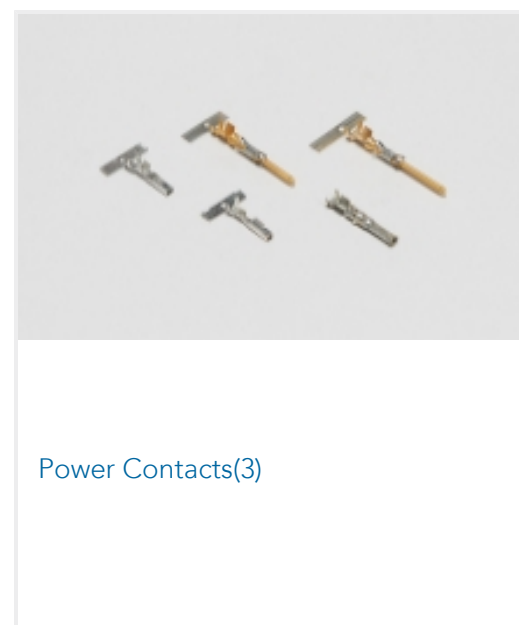
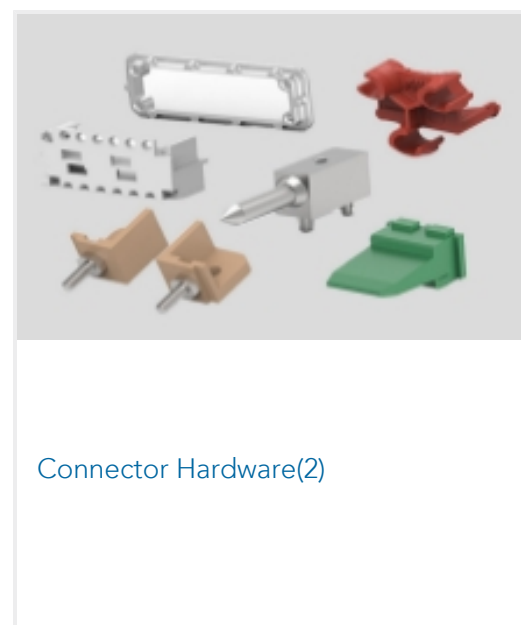
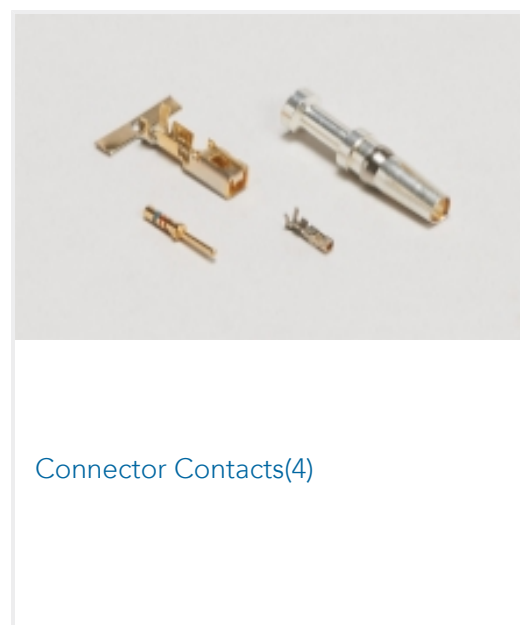
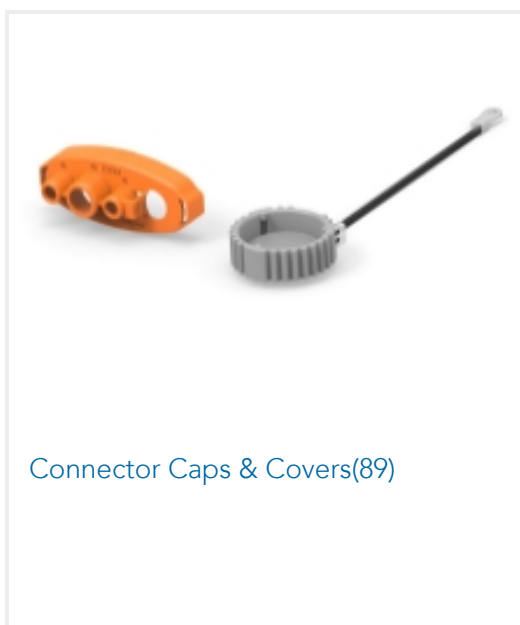



Rectangular Power Connectors(1178)

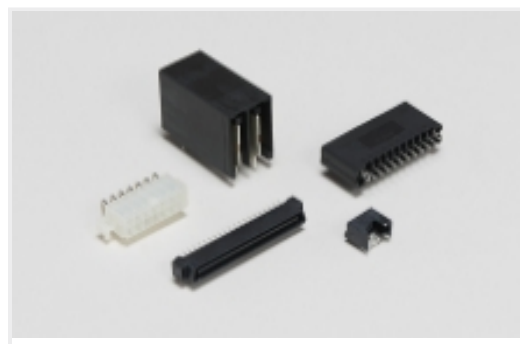

Standard Rectangular Connectors(667)

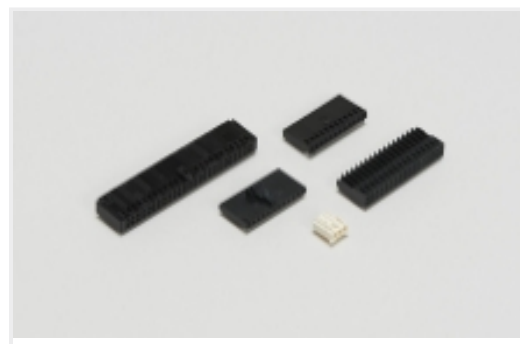

Wire-to-Board Connector Assemblies & Housings(594)

Customers Also Bought

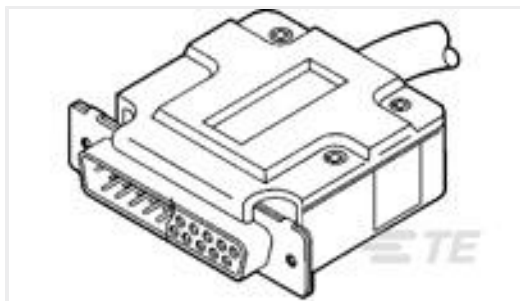

TE Part #207467-1
CABLE CLAMP KIT,SZ 1



TE Part #3-640428-5
05P MTA156 CONN ASSY 22AWG RED

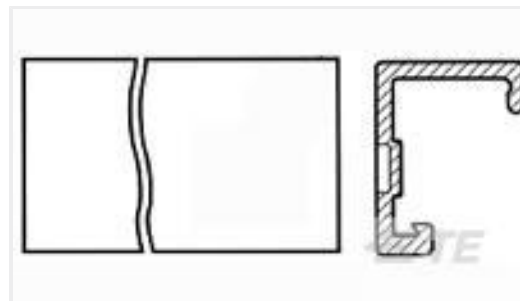

TE Part #640551-5
05P MTA156 COVER



TE Part #1393240-6
RT314615



TE Part #3-1437653-5
6PCV-10-006=6PCV ASSEMBLY



TE Part #1445022-3
MICRO MNL RFECEPT HSG SINGLE R

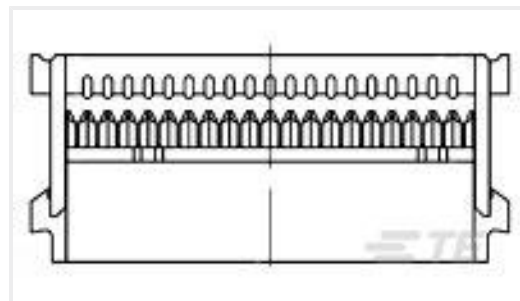

TE Part #1-1658526-6
609-2641LF FEM SOCKET,LEAD FREE

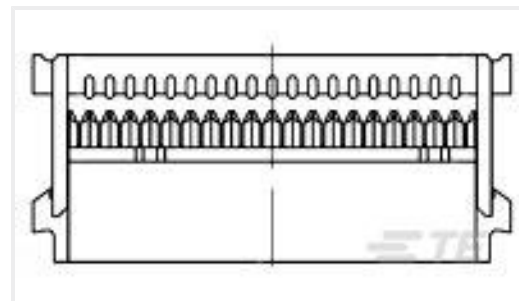

TE Part #2-1658526-4
609-5041LF FEM SOCKET,LEAD FREE



TE Part #1761681-7
IDC LOW PRO HDR 20P VERT HT
BLACK



TE Part #1-2008571-2
2 POS MICRO MNL, TOP LATCH, NA

Documents

Product Drawings

[05P MTA156 COVER F/T](#)

English

CAD Files

[3D PDF](#)

3D

[Customer View Model](#)

[ENG_CVM_CVM_640643-5_N.2d_dxf.zip](#)



English

Customer View Model

[ENG_CVM_CVM_640643-5_N.3d_igs.zip](#)

English

Customer View Model

[ENG_CVM_CVM_640643-5_N.3d_stp.zip](#)

English

Customer View Model

[ENG_CVM_640643-5_R.3d_igs.zip](#)

English

Customer View Model

[ENG_CVM_640643-5_R.3d_stp.zip](#)

English

Customer View Model

[ENG_CVM_640643-5_R.2d_dxf.zip](#)

English

3D PDF

English

By downloading the CAD file I accept and agree to the [Terms and Conditions](#) of use.

Product Specifications

Application Specification

Japanese

Application Specification

English

MTA 156 Ribbon Cable Connector Assemblies (English And Spanish)

English

MTA 156 Ribbon Cable Connector Assemblies (English And Spanish)

Japanese