



Connectors > Connector Accessories > Connector Caps & Covers > Nylon PCB Connector Covers: 2.54mm, MTA 100



Connector Cover Type: **Strain Relief Cover**

Primary Product Color: **White**

Primary Product Material: **Nylon**

Number of Positions: **2**

Operating Temperature (Max): **85 °C [185 °F]**

[All Nylon PCB Connector Covers: 2.54mm, MTA 100 \(40\)](#)

Features

Product Type Features

Product Profile	Standard
Connector Cover Type	Strain Relief Cover

Configuration Features

Number of Positions	2
---------------------	---

Body Features

Primary Product Color	White
Primary Product Material	Nylon

Mechanical Attachment

Strain Relief	With
---------------	------

Housing Features

Centerline (Pitch)	2.54 mm [.1 in]
--------------------	-----------------

Usage Conditions

Compatible With IDC Installation Type Connector	Feed Thru
---	-----------

Operating Temperature (Max)	85 °C[185 °F]
Operating Temperature Range	-40 – 85 °C[-40 – 185 °F]

Industry Standards

UL Flammability Rating	UL 94V-2
------------------------	----------

Product Compliance

[For compliance documentation, visit the product page on TE.com>](#)

EU RoHS Directive 2011/65/EU	Compliant
EU ELV Directive 2000/53/EC	Compliant
China RoHS 2 Directive MIIT Order No 32, 2016	No Restricted Materials Above Threshold
EU REACH Regulation (EC) No. 1907/2006	Current ECHA Candidate List: JUNE 2025 (250) Candidate List Declared Against: JUNE 2025 (250) Does not contain REACH SVHC
Halogen Content	Low Halogen - Br, Cl, F < 900 ppm per homogenous material. Also BFR/CFR/PVC Free
Solder Process Capability	Not applicable for solder process capability

Product Compliance Disclaimer

This information is provided based on reasonable inquiry of our suppliers and represents our current actual knowledge based on the information they provided. This information is subject to change. The part numbers that TE has identified as EU RoHS compliant have a maximum concentration of 0.1% by weight in homogenous materials for lead, hexavalent chromium, mercury, PBB, PBDE, DBP, BBP, DEHP, DIBP, and 0.01% for cadmium, or qualify for an exemption to these limits as defined in the Annexes of Directive 2011/65/EU (RoHS2). Finished electrical and electronic equipment products will be CE marked as required by Directive 2011/65/EU. Components may not be CE marked. Additionally, the part numbers that TE has identified as EU ELV compliant have a maximum concentration of 0.1% by weight in homogenous materials for lead, hexavalent chromium, and mercury, and 0.01% for cadmium, or qualify for an exemption to these limits as defined in the Annexes of Directive 2000/53/EC (ELV). Regarding the REACH Regulation, the information TE provides on SVHC in articles for this part number is based on the latest European Chemicals Agency (ECHA) 'Guidance on requirements for substances in articles' posted at this URL: <https://echa.europa.eu/guidance-documents/guidance-on-reach>

Compatible Parts





TE Part # 3-644694-2
02P MTA100 R/A HDR RETENTIVE



TE Part # CAT-104MTA-PRUMH
PCB Header: Polyester, Right Angle, 2.54 mm



TE Part # CAT-104MTA-PVUNH
PCB Header: Polyester, Vertical, Unshrouded, No Mating Alignment



TE Part # 3-644893-2
02P CST100 SHRD HDR ASSY LF



TE Part # CAT-104MTA-NGPNR
Nylon Gold Plated Receptacle: 2.54 mm, no Mating Alignment



TE Part # CAT-104MTA-NVTHH
Nylong Vertical PCB Header: 2.54mm, Through Hole, MTA 100



TE Part # CAT-104MTA-NTPNR
MTA Receptacle: Nylon, Tin Plated, 2.54 mm



TE Part # CAT-104MTA-PRSMH
PCB Header, Right Angle, Polyester, 2.54 mm



TE Part # CAT-104MTA-PRUSH
PCB Header: Polyester, Right Angle, Unshrouded



TE Part # CAT-104MTA-PVBRH
Polyester Vertical PCB Header: 2.54 mm, Breakaway, MTA 100



TE Part # CAT-104MTA-PVSHH
Polyester Vertical PCB Header: 2.54 mm, Shrouded, MTA 100



TE Part # 3-644894-2
02P CST100 SHRD HDR ASSY LF



TE Part # CAT-104MTA-NRTHH
PCB Header: Nylon, Right Angle, 2.54 mm



TE Part # 1375820-2
CST-100 II HOUSING 2 POS



TE Part # CAT-104MTA-PVUMH
PCB Header: Polyester, Vertical, 2.54 mm



TE Part # CAT-104MTA-NVSMH
PCB Header: Nylon, Vertical, Surface Mount, MTA 100

Also in the Series | **MTA 100**



Connector Caps & Covers(69)



Connector Contacts(8)



Connector Hardware(1)



PCB Headers & Receptacles(441)

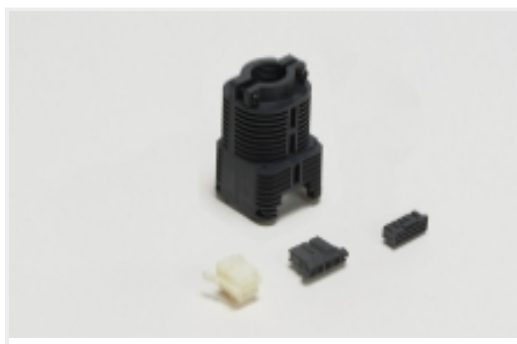

Rectangular Connector Housings(1)



Rectangular Power Connectors(1)

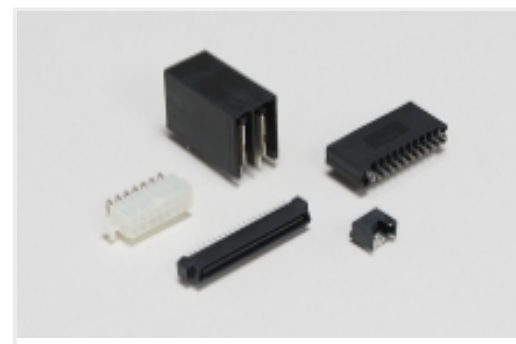

Standard Rectangular Connectors(496)

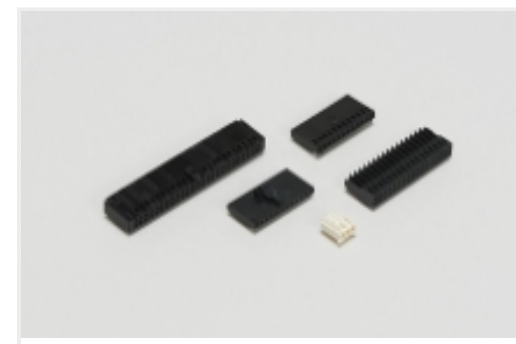

Wire-to-Board Connector Assemblies & Housings(457)

Customers Also Bought

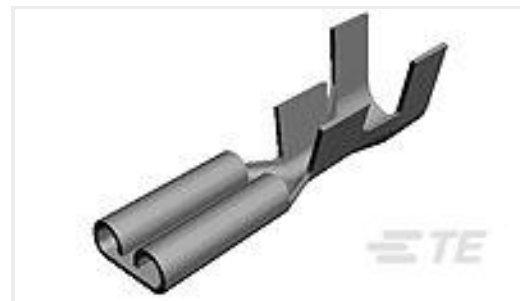
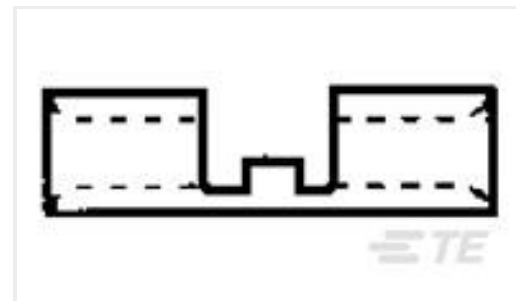
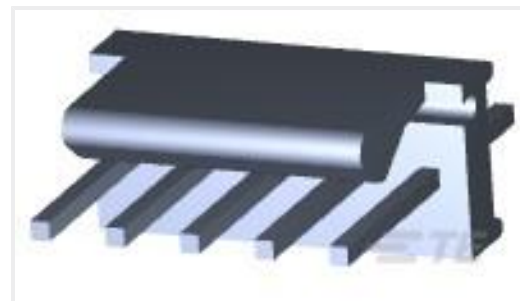
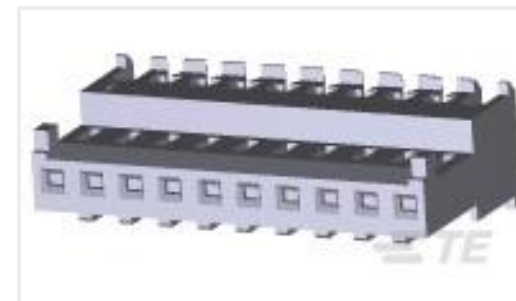
TE Part #2-34852-1
TERMINAL,PG R 12-10 6TE Part #60705-1
FASTON 250 REC 18-14 AWG NPSTTE Part #323698
SPLICE,SOLIS BUTT HT 12-10TE Part #4-640440-0
10P MTA100 CONN ASSY 22AWG REDTE Part #640907-2
RECEPT,PIDG FASTON 12-10 250TE Part #3-641126-5
05P MTA100 HDR ASY FL/STR LFTE Part #CAT-104MTA-NYLCC
Nylon PCB Connector Covers: 2.54 mm, MTA 100TE Part #4-644540-0
10P MTA100 CONN ASSY F/T POLTE Part #5-1419102-4
T9AP5D52-12

Documents

Product Drawings

02P MTA100 MOLDED COVER F/T

English

CAD Files

3D PDF

3D

Customer View Model

ENG_CVM_CVM_643077-2_S.2d_dxf.zip



English

Customer View Model

[ENG_CVM_CVM_643077-2_S.3d_igs.zip](#)

English

Customer View Model

[ENG_CVM_CVM_643077-2_S.3d_stp.zip](#)

English

[3D PDF](#)

English

Customer View Model

[ENG_CVM_643077-2_L.2d_dxf.zip](#)

English

Customer View Model

[ENG_CVM_643077-2_L.3d_igs.zip](#)

English

Customer View Model

[ENG_CVM_643077-2_L.3d_stp.zip](#)

English

By downloading the CAD file I accept and agree to the [Terms and Conditions](#) of use.

Product Specifications

[Application Specification](#)

English

Instruction Sheets

[Instruction Sheet \(U.S.\)](#)

English