

644875-6 ✓ ACTIVE

MTA 100

TE Internal #: 644875-6

PCB Mount Header, Right Angle, Wire-to-Board, 6 Position, 2.54 mm [.1 in] Centerline, Partially Shrouded, Tin (Sn), Through Hole - Solder, MTA 100

[View on TE.com >](#)



Connectors > PCB Connectors > PCB Headers & Receptacles > PCB Header: Polyester, Right Angle, Unshrouded

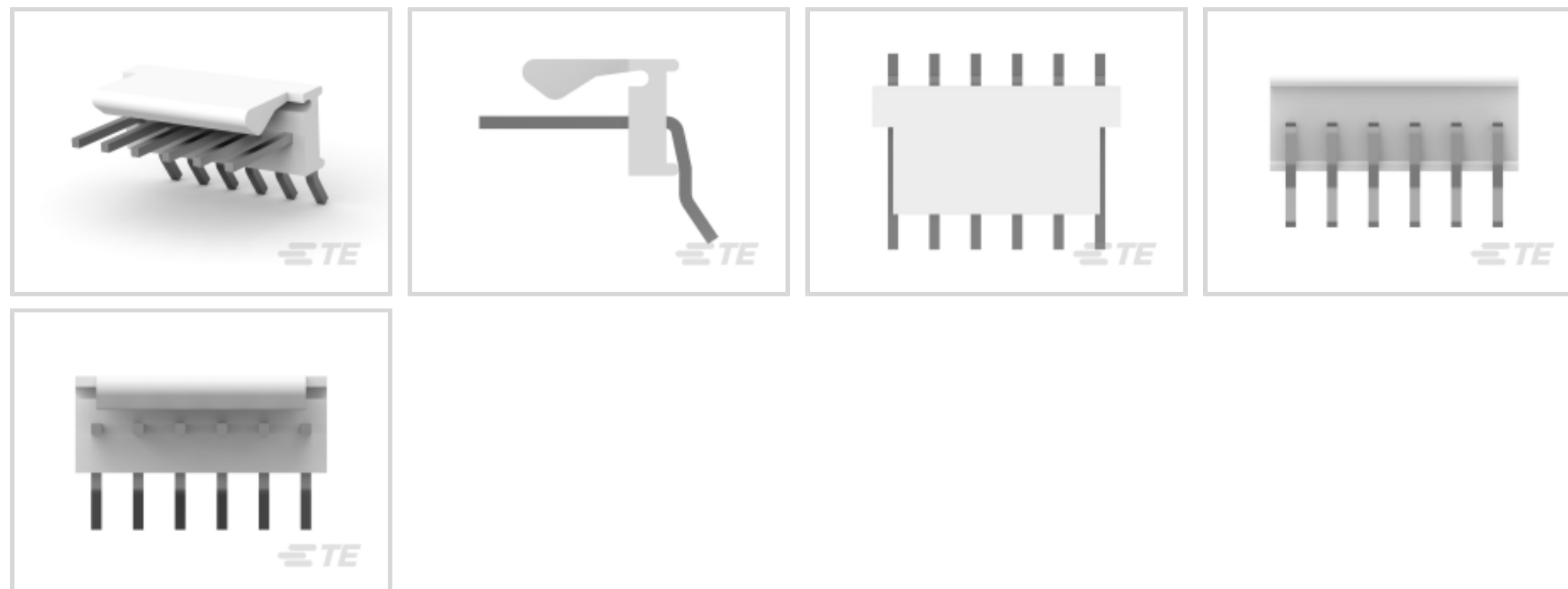

PCB Connector Type: **PCB Mount Header**

PCB Mount Orientation: **Right Angle**

Connector System: **Wire-to-Board**

Number of Positions: **6**

Centerline (Pitch): **2.54 mm [.1 in]**

[All PCB Header: Polyester, Right Angle, Unshrouded \(80\)](#)

Features

Product Type Features

PCB Connector Type	PCB Mount Header
Connector System	Wire-to-Board
Header Type	Partially Shrouded
Sealable	No
Connector & Contact Terminates To	Printed Circuit Board
Connector Product Type	Connector Assembly

Configuration Features

Number of Columns	6
PCB Mount Orientation	Right Angle
Number of Positions	6
Number of Rows	1

Electrical Characteristics



Operating Voltage	250 VAC
-------------------	---------

Body Features

Primary Product Color	Natural
-----------------------	---------

Contact Features

Contact Underplating Material	Nickel
-------------------------------	--------

Contact Underplating Material Thickness	1.27 μm [50 μin]
---	---

PCB Contact Termination Area Plating Material Finish	Matte
--	-------

Mating Square Post Dimension	.64 mm[.025 in]
------------------------------	-----------------

PCB Contact Termination Area Plating Material Thickness	3.81 μm [150 μin]
---	--

Contact Shape & Form	Square
----------------------	--------

Contact Layout	Inline
----------------	--------

Contact Mating Area Length	7.49 mm[.295 in]
----------------------------	------------------

Contact Base Material	Copper Alloy
-----------------------	--------------

PCB Contact Termination Area Plating Material	Tin
---	-----

Contact Mating Area Plating Material	Tin (Sn)
--------------------------------------	----------

Contact Mating Area Plating Material Finish	Matte
---	-------

Contact Mating Area Plating Material Thickness	3.81 μm [150 μin]
--	--

Contact Type	Pin
--------------	-----

Contact Current Rating (Max)	5 A
------------------------------	-----

Termination Features

Termination Post & Tail Length	3.43 mm[.135 in]
--------------------------------	------------------

Square Termination Post & Tail Dimension	.64 mm[.025 in]
--	-----------------

Termination Method to PCB	Through Hole - Solder
---------------------------	-----------------------

Mechanical Attachment

Panel Mount Feature	Without
---------------------	---------

Mating Retention Type	Friction Lock
-----------------------	---------------

Mating Alignment Type	Polarization
-----------------------	--------------

PCB Mount Retention Type	Retention Leg
--------------------------	---------------

PCB Mount Alignment	Without
---------------------	---------

Mating Retention	With
------------------	------

PCB Mount Retention	With
---------------------	------

Connector Mounting Type	Board Mount
-------------------------	-------------

Mating Alignment	With
------------------	------



Housing Features

Right Angle Bending Side	Front
Centerline (Pitch)	2.54 mm [.1 in]
Housing Material	Polyester GF

Dimensions

PCB Thickness (Recommended)	1.6 mm [.063 in]
Connector Height	5.72 mm [.225 in]
Connector Length	14.94 mm [.6 in]

Usage Conditions

Operating Temperature Range	-55 – 105 °C [-67 – 221 °F]
-----------------------------	-----------------------------

Operation/Application

Circuit Application	Signal
---------------------	--------

Industry Standards

Compatible With Agency/Standards Products	CSA, UL
Compatible With Approved Standards Products	CSA LR7189, UL E28476
UL Flammability Rating	UL 94V-0

Packaging Features

Packaging Quantity	1
Packaging Method	Package

Product Compliance

[For compliance documentation, visit the product page on TE.com>](#)

EU RoHS Directive 2011/65/EU	Compliant
EU ELV Directive 2000/53/EC	Compliant
China RoHS 2 Directive MIIT Order No 32, 2016	No Restricted Materials Above Threshold
EU REACH Regulation (EC) No. 1907/2006	Current ECHA Candidate List: JUNE 2025 (250) Candidate List Declared Against: JUNE 2025 (250) Does not contain REACH SVHC
Halogen Content	Not Low Halogen - contains Br or Cl > 900 ppm.
Solder Process Capability	Hand solderable with tin/lead solder

Product Compliance Disclaimer

This information is provided based on reasonable inquiry of our suppliers and represents our current actual knowledge based on the information they provided. This information is subject to change. The part numbers that TE has identified as EU RoHS compliant have a maximum concentration of 0.1% by weight in homogenous materials for lead, hexavalent chromium, mercury, PBB, PBDE, DBP, BBP, DEHP, DIBP, and 0.01% for cadmium, or qualify for an exemption to these limits as defined in the Annexes of Directive 2011/65/EU (RoHS2). Finished electrical and electronic equipment products will be CE marked as required by Directive 2011/65/EU. Components may not be CE marked. Additionally, the part numbers that TE has identified as EU ELV compliant have a maximum concentration of 0.1% by weight in homogenous materials for lead, hexavalent chromium, and mercury, and 0.01% for cadmium, or qualify for an exemption to these limits as defined in the Annexes of Directive 2000/53/EC (ELV). Regarding the REACH Regulation, the information TE provides on SVHC in articles for this part number is based on the latest European Chemicals Agency (ECHA) 'Guidance on requirements for substances in articles' posted at this URL: <https://echa.europa.eu/guidance-documents/guidance-on-reach>

Compatible Parts

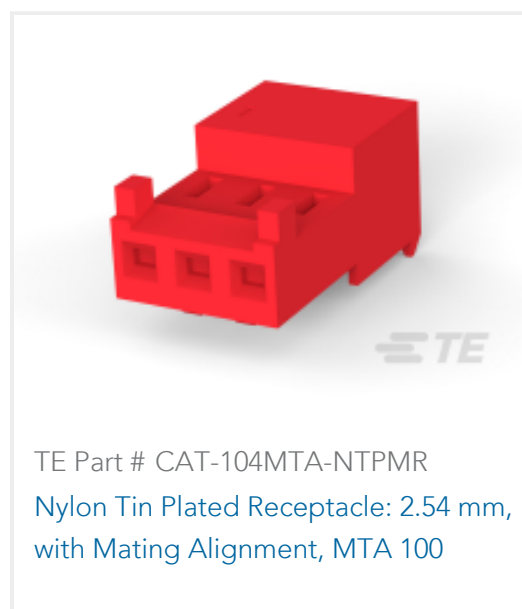

Also in the Series | MTA 100

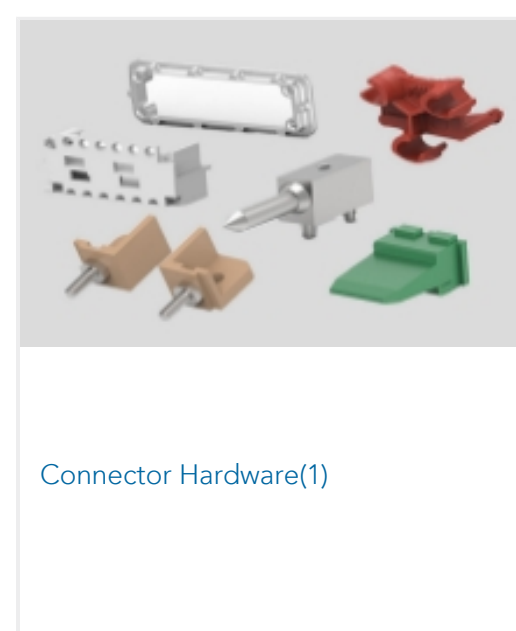
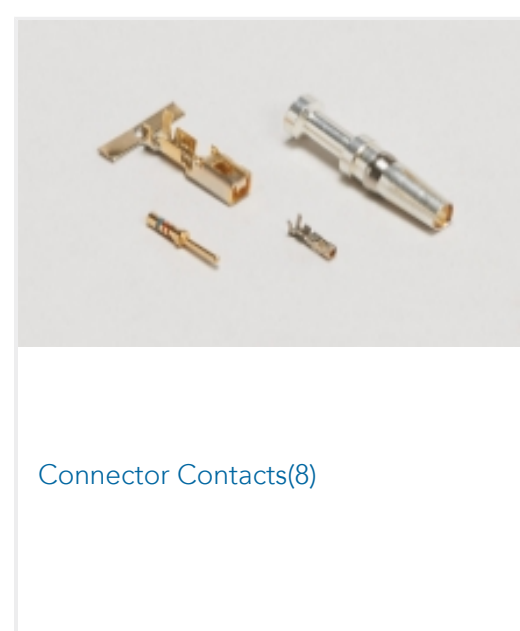
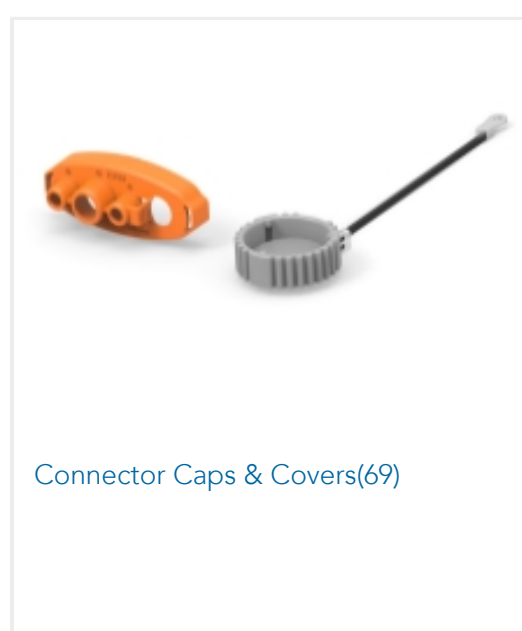

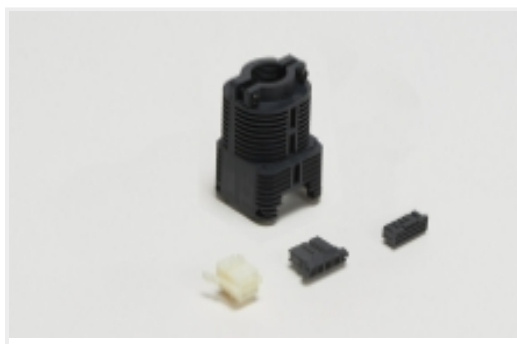

Rectangular Connector Housings(1)



Rectangular Power Connectors(1)

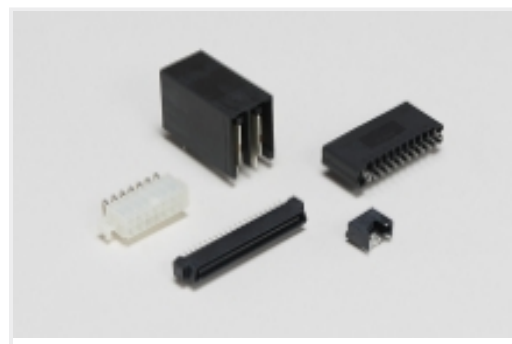

Standard Rectangular Connectors(496)

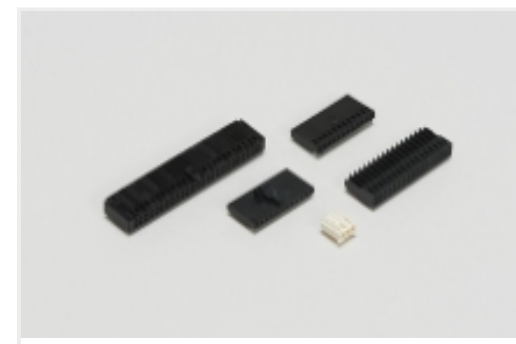
Wire-to-Board Connector Assemblies
& Housings(457)

Customers Also Bought

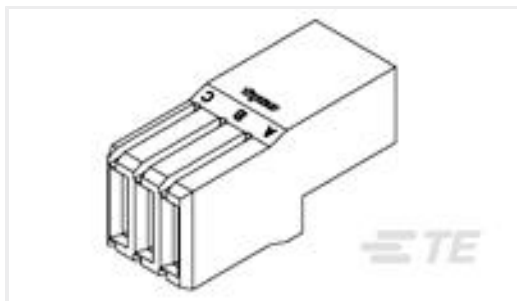
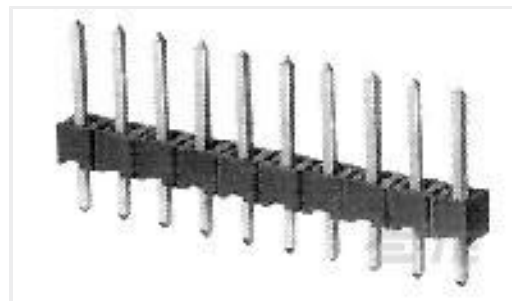
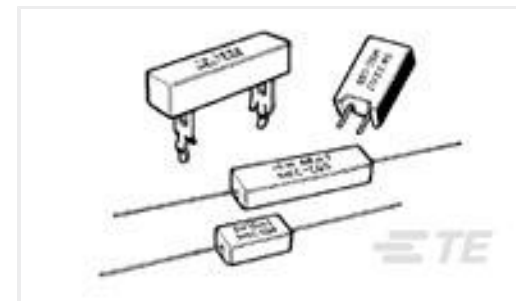
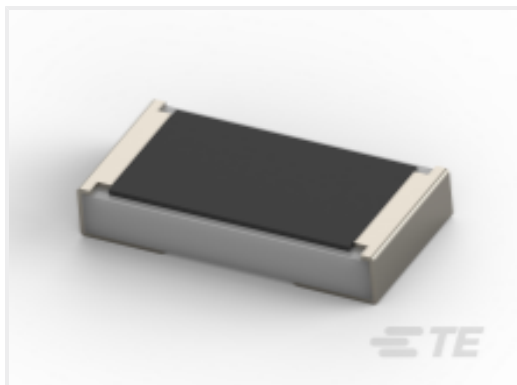
TE Part #120943-1
UPM R/A REC HC 3P Power ConnectorTE Part #5-534237-2
04 MODII VRT SR CE 100/115TE Part #826646-4
4P AMPMODU II STIFT LEITE Part #1623802-4
SQZ15 5K 5% (METAL FILM)TE Part #CAT-C339-A76B
SMD Power Resistor: 3 Watt, 1% TolTE Part #2301994-1
RJ45 JACK INT.MAG. 10/100 1X1 INV.TE Part #1623708-1
RGP0207CH 5% 100MTE Part #1-1623708-2
RGP0207CH 10% 1G0

Documents

Product Drawings

[06P MTA100 HDR ASSY F/L,SP BND](#)

English

CAD Files

Customer View Model

[ENG_CVM_644875-6_D.3d_igs.zip](#)

English

Customer View Model

[ENG_CVM_644875-6_D.2d_dxf.zip](#)

English

3D PDF

English

Customer View Model

[ENG_CVM_644875-6_D.3d_stp.zip](#)

English

By downloading the CAD file I accept and agree to the [Terms and Conditions](#) of use.



Product Specifications

[Application Specification](#)

English

Agency Approvals

[Agency Approval Document](#)

English