

SL-156

TE Internal #: 647402-3

3 Position, Receptacle, Housing, Crimp, Wire-to-Board, UL 94V-0,
3.96 mm [.156 in] Centerline, 1 Row, 250 VAC, Wire & Cable, Power
& Signal, SL-156

[View on TE.com >](#)

Connectors > Rectangular Connectors > Standard Rectangular Connectors > Receptacle Housing: Wire-to-Board, with Mating Alignment, SL156

Connector Product Type: **Housing**Connector & Housing Type: **Receptacle**Mating Retention Type: **Locking Ramp**Connector System: **Wire-to-Board**Contact Retention Within Housing: **Without**
[All Receptacle Housing: Wire-to-Board, with Mating Alignment, SL156 \(107\)](#)

Features

Product Type Features

Connector Product Type	Housing
Connector & Housing Type	Receptacle
Connector System	Wire-to-Board
Sealable	No
Connector & Contact Terminates To	Wire & Cable

Configuration Features

Number of Positions	3
Number of Rows	1

Electrical Characteristics

Operating Voltage	250 VAC
-------------------	---------

Body Features

Primary Product Color	Natural
-----------------------	---------



Contact Features

Contact Retention Within Housing	Without
Contact Type	Socket
Contact Current Rating (Max)	6.5 A

Termination Features

Termination Method to Wire & Cable	Crimp
------------------------------------	-------

Mechanical Attachment

Strain Relief	Without
Panel Mount Feature	Without
Mating Retention Type	Locking Ramp
Mating Retention	With
Connector Mounting Type	Cable Mount (Free-Hanging)

Housing Features

Housing Entry Configuration	Left End Open
Centerline (Pitch)	3.96 mm [.156 in]
Housing Material	Nylon GF

Dimensions

	.346 in
Connector Height	6.35 mm
Wire Size	.0509 – .823 mm ²

Usage Conditions

Operating Temperature Range	-55 – 105 °C [-67 – 221 °F]
-----------------------------	-----------------------------

Operation/Application

Circuit Application	Power & Signal
---------------------	----------------

Industry Standards

Compatible With Agency/Standards Products	CSA, UL
UL Flammability Rating	UL 94V-0

Packaging Features

Packaging Quantity	1
Packaging Method	Package

Product Compliance



[For compliance documentation, visit the product page on TE.com>](#)

EU RoHS Directive 2011/65/EU	Compliant
EU ELV Directive 2000/53/EC	Compliant
China RoHS 2 Directive MIIT Order No 32, 2016	有害物质含量符合标准要求 No Restricted Substance(s) Above Threshold
EU REACH Regulation (EC) No. 1907/2006	Current ECHA Candidate List: JUNE 2025 (250) Candidate List Declared Against: JUNE 2025 (250) Does not contain REACH SVHC
Halogen Content	Low Halogen - Br, Cl, F < 900 ppm per homogenous material. Also BFR/CFR/PVC Free
Solder Process Capability	Not applicable for solder process capability

Product Compliance Disclaimer

This information is provided based on reasonable inquiry of our suppliers and represents our current actual knowledge based on the information they provided. This information is subject to change. The part numbers that TE has identified as EU RoHS compliant have a maximum concentration of 0.1% by weight in homogenous materials for lead, hexavalent chromium, mercury, PBB, PBDE, DBP, BBP, DEHP, DIBP, and 0.01% for cadmium, or qualify for an exemption to these limits as defined in the Annexes of Directive 2011/65/EU (RoHS2). Finished electrical and electronic equipment products will be CE marked as required by Directive 2011/65/EU. Components may not be CE marked. Additionally, the part numbers that TE has identified as EU ELV compliant have a maximum concentration of 0.1% by weight in homogenous materials for lead, hexavalent chromium, and mercury, and 0.01% for cadmium, or qualify for an exemption to these limits as defined in the Annexes of Directive 2000/53/EC (ELV). Regarding the REACH Regulation, the information TE provides on SVHC in articles for this part number is based on the latest European Chemicals Agency (ECHA) 'Guidance on requirements for substances in articles' posted at this URL: <https://echa.europa.eu/guidance-documents/guidance-on-reach>

Compatible Parts



TE Part # 640385-3
03P MTA156 HDR ASSY SQ R/A



TE Part # 2472633-1
03P MTA156 HDR ASSY W/O#2 LF W/ CHMFR



TE Part # 644749-3
03P MTA156 HDR ASSY STR SQ SN



TE Part # 641937-1
03P MTA156 HDR ASSY STR W/O#2



Also in the Series | **SL-156**

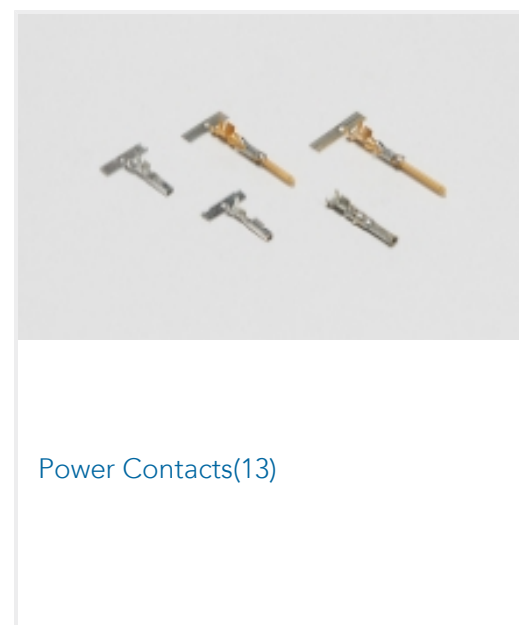
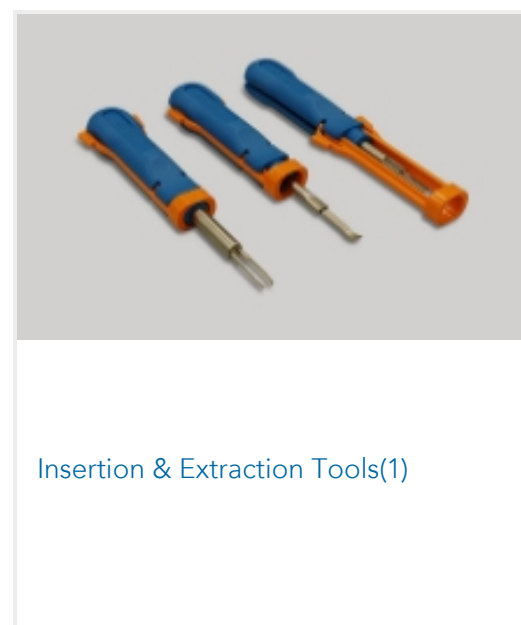
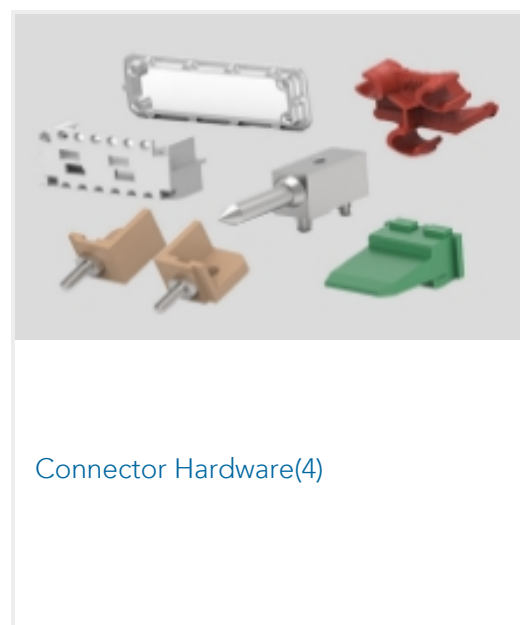
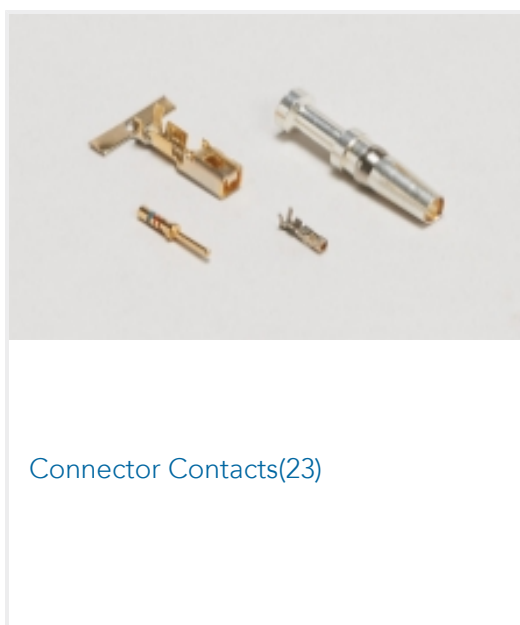



Rectangular Connector Housings(150)

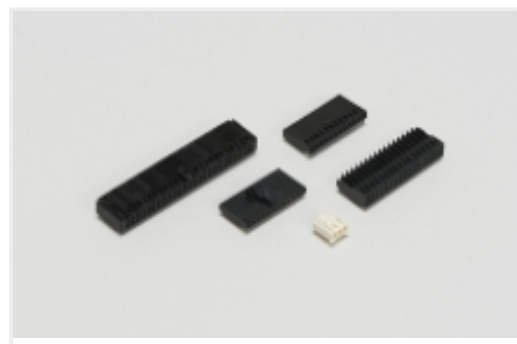

Rectangular Power Connectors(147)

Wire-to-Board Connector Assemblies
& Housings(146)

Customers Also Bought

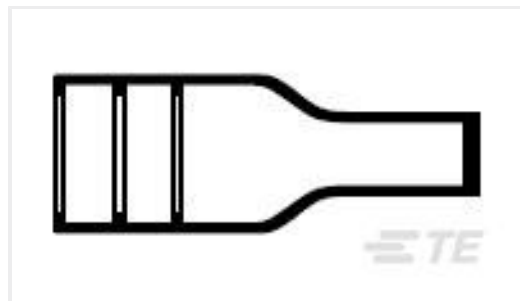
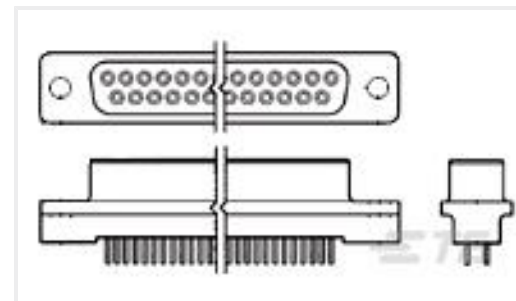
TE Part #7755894002
MT2000-1.0-X-SPTE Part #808381-000
202D132-4/42-0TE Part #CV4186-000
RNF-100-1/4-BK-SP-SHTE Part #102153-4
020 UNIV HDR SP 4S 15DP STDTE Part #323152
DG 22-16COM 22-18MIL HR R 8TE Part #CAT-103156-WBHSM
Receptacle Housing: Wire-to-Board,
with Mating Alignment, SL156TE Part #CAT-103156-WTBCC
Connector Contacts: Wire-to-Board
Socket, SL 156TE Part #5745078-6
HD-20 RCPT 25P VERT FFSCRLK

Documents

Product Drawings

[03P SL156 HSG W/RMP&TABS,OVSZ](#)

English

CAD Files

Customer View Model

[ENG_CVM_CVM_647402-3_C.2d_dxf.zip](#)

English

3D PDF

3D

Customer View Model

[ENG_CVM_CVM_647402-3_C.3d_igs.zip](#)

English

Customer View Model

[ENG_CVM_CVM_647402-3_C.3d_stp.zip](#)

English

By downloading the CAD file I accept and agree to the [Terms and Conditions](#) of use.



Product Specifications

Application Specification

English

Agency Approvals

UL Report

English