



Connectors > Connector Accessories > Connector Seals & Cavity Plugs



Connector Seal & Plug Type: **Cavity Plug**

Cavity Diameter: **2.3 mm [.09 in]**

Primary Product Color: **Brown**

Primary Product Material: **Silicone**

Shore A Hardness: **50**

Features

Product Type Features

Connector Seal & Plug Type	Cavity Plug
----------------------------	-------------

Body Features

Primary Product Color	Brown
Primary Product Material	Silicone

Dimensions

Cavity Diameter	2.3 mm [.09 in]
-----------------	-----------------

Other

Shore A Hardness	50
Contains Lubricant	Yes

Product Compliance

[For compliance documentation, visit the product page on TE.com>](#)

EU RoHS Directive 2011/65/EU	Compliant
EU ELV Directive 2000/53/EC	Compliant







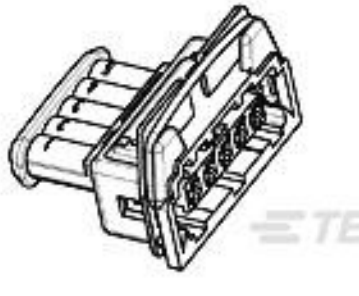

China RoHS 2 Directive MIIT Order No 32, 2016	No Restricted Materials Above Threshold
EU REACH Regulation (EC) No. 1907/2006	Current ECHA Candidate List: JAN 2025 (247) Candidate List Declared Against: JAN 2025 (247) Does not contain REACH SVHC
Halogen Content	BFR/CFR/PVC Free, but Br/Cl >900 ppm in other sources.
Solder Process Capability	Not applicable for solder process capability

Product Compliance Disclaimer

This information is provided based on reasonable inquiry of our suppliers and represents our current actual knowledge based on the information they provided. This information is subject to change. The part numbers that TE has identified as EU RoHS compliant have a maximum concentration of 0.1% by weight in homogenous materials for lead, hexavalent chromium, mercury, PBB, PBDE, DBP, BBP, DEHP, DIBP, and 0.01% for cadmium, or qualify for an exemption to these limits as defined in the Annexes of Directive 2011/65/EU (RoHS2). Finished electrical and electronic equipment products will be CE marked as required by Directive 2011/65/EU. Components may not be CE marked. Additionally, the part numbers that TE has identified as EU ELV compliant have a maximum concentration of 0.1% by weight in homogenous materials for lead, hexavalent chromium, and mercury, and 0.01% for cadmium, or qualify for an exemption to these limits as defined in the Annexes of Directive 2000/53/EC (ELV). Regarding the REACH Regulation, the information TE provides on SVHC in articles for this part number is based on the latest European Chemicals Agency (ECHA) 'Guidance on requirements for substances in articles' posted at this URL: <https://echa.europa.eu/guidance-documents/guidance-on-reach>

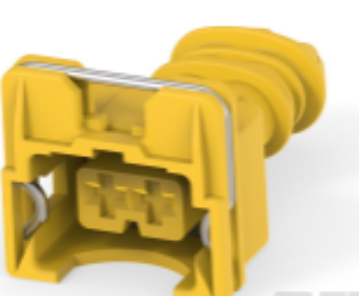
Compatible Parts

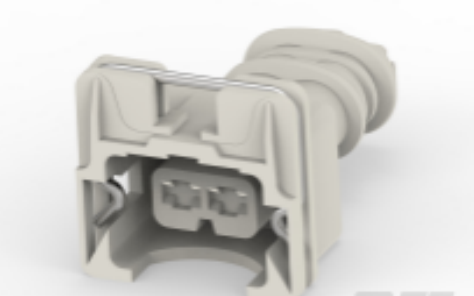
 <p>TE Part # 953310-3 5W JPT/SWS CET CON</p>	 <p>TE Part # 282246-1 SPLASH PROOF FEMALE CONN:3 VIE</p>	 <p>TE Part # 284953-1 12 POS. FEMALE CONNECTOR FOR S</p>	 <p>TE Part # CAT-NB3-MRC48 48V Ready Mixed (Signal and Power) Connectors</p>
 <p>TE Part # 282956-7 SPLASH-PROOF FEM CONN ASSY</p>	 <p>TE Part # 1-282236-2 6 POS. SPLASH PROOF CONNECTOR ASS'Y</p>	 <p>TE Part # CAT-T4827-CH8172 Timer Connector Housing</p>	 <p>TE Part # 282762-3 JPT SPLASH-PROOF FEM.CONN2 POS</p>



TE Part # 282729-2
SPLASH PROOF CONN. ASS'Y



TE Part # CAT-AM705-CH8172
AMP MCP, SEALED CONNECTOR HOUSING



TE Part # 1-284844-0
12 POS MCP HYBRID MALE CONNECTOR



TE Part # 2137216-2
3P SPLASH PROOF CONNECTOR ASS'



TE Part # 282189-8
SPLASH PROOF CONN. W.S.L.



TE Part # 282648-1
SPLASH PROOF CONN. W.S.L. 2 WAY

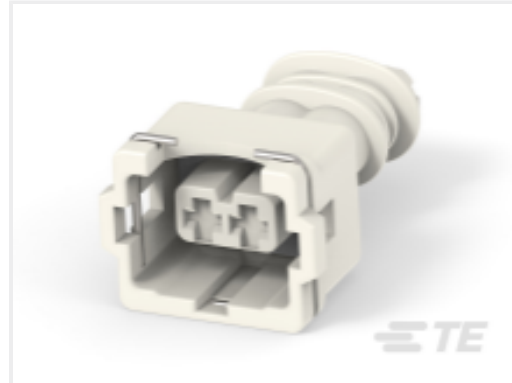

TE Part # 282788-3
SPLASH-PROOF CONN W.S.L. 2P TY



TE Part # 2137216-1
3P SPLASH PROOF CONNECTOR ASS'

Also in the Series | Timer Connector System



Automotive Connector Caps & Covers (12)

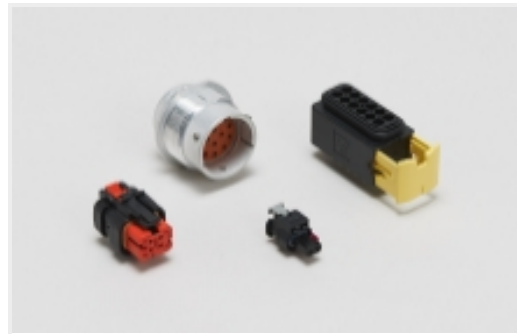

Automotive Housings(188)



Automotive Signal & Power Connector Housings(138)



Automotive Signal & Power Headers(9)

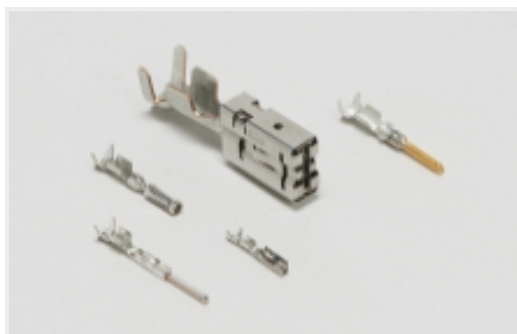

Automotive Terminals(110)



Quick Disconnects(4)

Customers Also Bought



TE Part #539515-000
ES2000-NO.3-B8-0-65MM

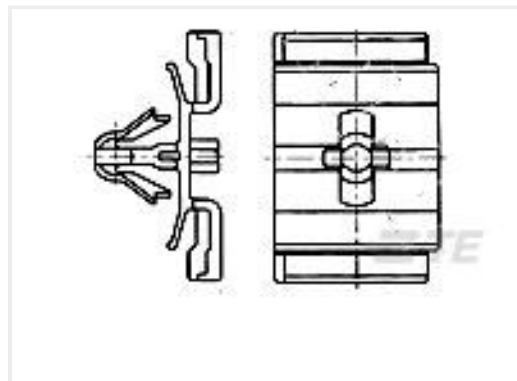

TE Part #282322-1
HOOK FOR SEALED SEC.CONN.

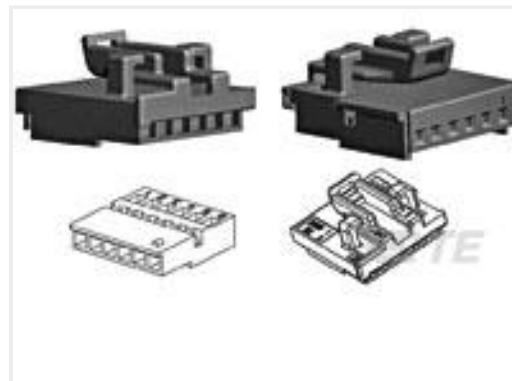

TE Part #284802-1
6POS MQS REC COD A



TE Part #284844-1
12 POS MCP HYBRID MALE CONN AS

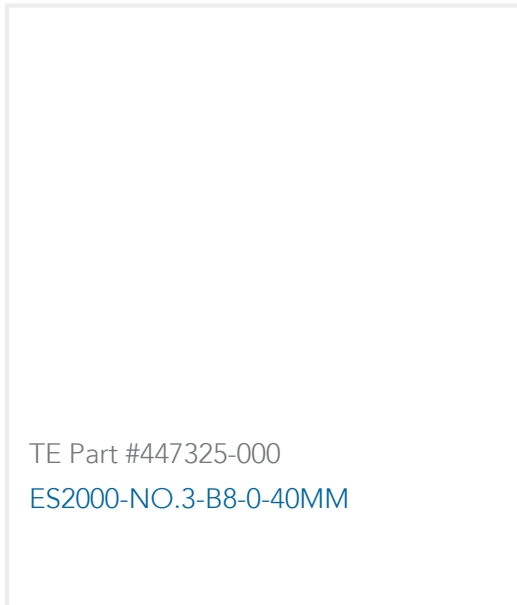

Documents

Product Drawings

BLINDSTOPFEN 1,5SYS

German

CAD Files

3D PDF

3D

Customer View Model

[ENG_CVM_CVM_828906-2_E.2d_dxf.zip](#)

English

Customer View Model

[ENG_CVM_CVM_828906-2_E.3d_igs.zip](#)

English

Customer View Model

[ENG_CVM_CVM_828906-2_E.3d_stp.zip](#)

English

By downloading the CAD file I accept and agree to the [Terms and Conditions](#) of use.

Product Specifications

Product Specification

English

55 POS. J.P.T. WATER PROOF CONNECTOR

English

10 & 29 pos. door to body

English

Product Specification

English

