

963343-1 ✓ ACTIVE



AMP | Junior Power Timer

TE Internal #: 963343-1

12 V / 24 V, 2 Position, Automotive Housing for Female Terminals,
Wire-to-Wire, 5 mm [.197 in] Centerline, Sealable, Gray, Junior
Power Timer

[View on TE.com >](#)

Automotive Parts > Automotive Connectors > Automotive Housings > Timer Connector Housing

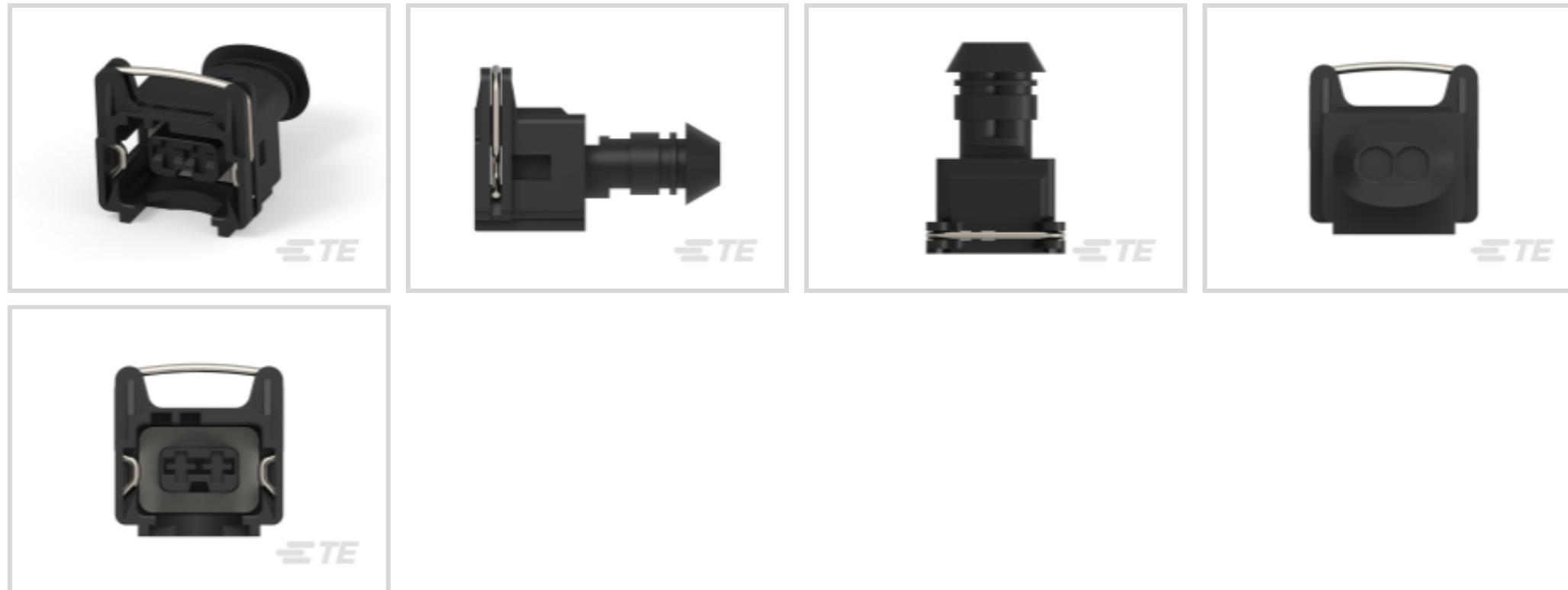

Nominal Voltage Architecture: 12 V, 24 V

Connector & Housing Type: **Housing for Female Terminals**

Number of Positions: 2

Sealable: **Yes**

Operating Temperature Range: -40 – 100 °C [-40 – 212 °F]

[All Timer Connector Housing \(436\)](#)

Features

Product Type Features

Mixed & Hybrid Connector	No
Connector Shape	Rectangular
Connector & Housing Type	Housing for Female Terminals
Sealable	Yes
Primary Locking Feature	Locking Lance
Connector System	Wire-to-Wire
Connector & Contact Terminates To	Wire & Cable

Configuration Features

Number of Positions	2
Number of Rows	1

Electrical Characteristics

Nominal Voltage Architecture	12 V, 24 V
------------------------------	------------



Body Features

Cable Exit Angle	180 °
Primary Product Color	Gray
Connector & Keying Code	2

Contact Features

Contact Size	2.8mm
Contact Type	Receptacle
Mating Tab Width	2.8 mm[.11 in]
Contact Current Rating (Max)	10 A

Mechanical Attachment

Strain Relief	Without
Terminal Position Assurance	No
Mating Alignment Type	Keyed
Mating Alignment	With
Connector Mounting Type	Cable Mount (Free-Hanging)

Housing Features

Housing Material	PBT GF15
Centerline (Pitch)	5 mm[.197 in]

Dimensions

Product Width	35.5 mm[1.39 in]
Product Length	23.4 mm[.921 in]
Connector Height	35.5 mm[1.398 in]

Usage Conditions

Operating Temperature Range	-40 – 100 °C[-40 – 212 °F]
Operating Temperature (Max)	100 °C[212 °F]

Operation/Application

Circuit Application	Power
---------------------	-------

Industry Standards

UL Flammability Rating	UL 94HB
------------------------	---------

Packaging Features

Packaging Quantity	1150
Packaging Method	Bag



Other

Serviceable	No
Connector Position Assurance Capable	No

Product Compliance

[For compliance documentation, visit the product page on TE.com>](#)

EU RoHS Directive 2011/65/EU	Compliant
EU ELV Directive 2000/53/EC	Compliant
China RoHS 2 Directive MIIT Order No 32, 2016	有害物质含量符合标准要求 No Restricted Substance(s) Above Threshold
EU REACH Regulation (EC) No. 1907/2006	Current ECHA Candidate List: JUNE 2025 (250) Candidate List Declared Against: JUNE 2025 (250) Does not contain REACH SVHC
Halogen Content	Not Low Halogen - contains Br or Cl > 900 ppm.
Solder Process Capability	Not applicable for solder process capability

Product Compliance Disclaimer

This information is provided based on reasonable inquiry of our suppliers and represents our current actual knowledge based on the information they provided. This information is subject to change. The part numbers that TE has identified as EU RoHS compliant have a maximum concentration of 0.1% by weight in homogenous materials for lead, hexavalent chromium, mercury, PBB, PBDE, DBP, BBP, DEHP, DIBP, and 0.01% for cadmium, or qualify for an exemption to these limits as defined in the Annexes of Directive 2011/65/EU (RoHS2). Finished electrical and electronic equipment products will be CE marked as required by Directive 2011/65/EU. Components may not be CE marked. Additionally, the part numbers that TE has identified as EU ELV compliant have a maximum concentration of 0.1% by weight in homogenous materials for lead, hexavalent chromium, and mercury, and 0.01% for cadmium, or qualify for an exemption to these limits as defined in the Annexes of Directive 2000/53/EC (ELV). Regarding the REACH Regulation, the information TE provides on SVHC in articles for this part number is based on the latest European Chemicals Agency (ECHA) 'Guidance on requirements for substances in articles' posted at this URL: <https://echa.europa.eu/guidance-documents/guidance-on-reach>

Compatible Parts

TE Part # 828884-1 DICHTUNG F 828791	TE Part # 827547-1 SPRING	TE Part # 962497-1 JUN-POW-TIM GEH 2P
---	------------------------------	--



Also in the Series | Junior Power Timer

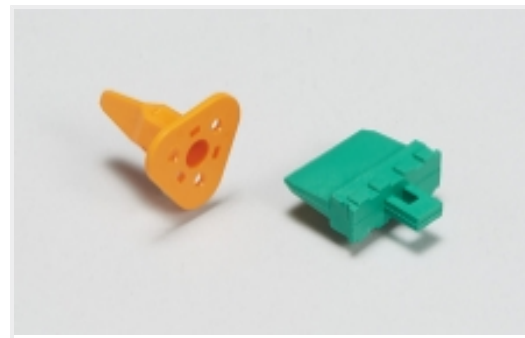

Automotive Connector Locks & Position Assurance(8)

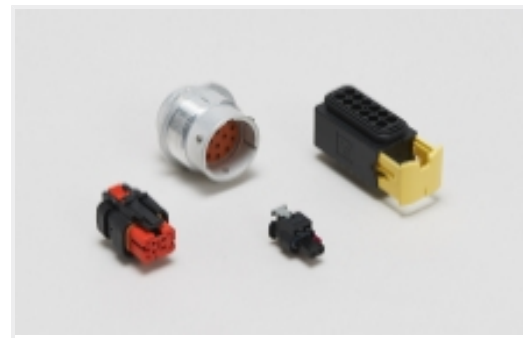

Automotive Housings(279)



Automotive Seals & Cavity Plugs(8)



Automotive Signal & Power Connector Housings(275)

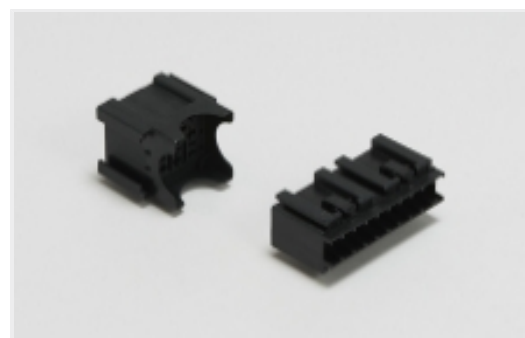

Module Components(1)



Other Automotive Connector Accessories(3)

Customers Also Bought



TE Part #DT06-12SA-B016
PLG, 12P, GRY, N, ENH KEY, A



TE Part #ANT-433-CW-HW-SMA
Antenna 1/4 Wave Whip 433MHz SMA

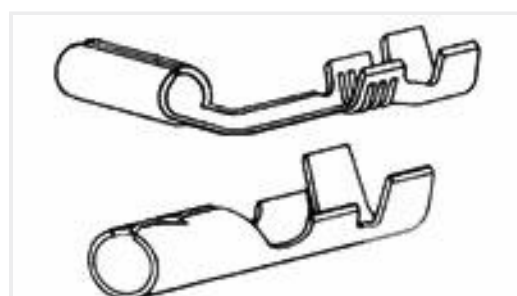

TE Part #42581-2
SHUR PLUG 156 RECEPTACLE 22-18 AWG TPBR



TE Part #282189-4
SPLASH PROOF CONN. W.S.L.

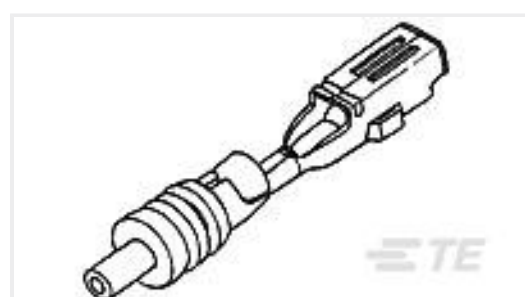

TE Part #345806-1
ECONO CONTACT REC



TE Part #927777-6
JUNIOR POWER TIMER CONTACT



TE Part #CAT-N14-RC4812
48V Ready 1.2mm Sealed Connectors



TE Part #8-1879343-8
CPF 0805 10K 1% 50PPM 1K RL

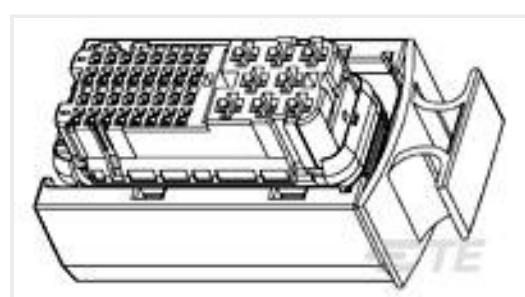

TE Part #368383-1
40P REC HSG ASSY() BLK



Documents

Product Drawings

[J-P-T GEH KOMPL 2P](#)

English

CAD Files

[3D PDF](#)

English

Customer View Model

[ENG_CVM_963343-1_G.2d_dxf.zip](#)

English

Customer View Model

[ENG_CVM_963343-1_G.3d_igs.zip](#)

English

Customer View Model

[ENG_CVM_963343-1_G.3d_stp.zip](#)

English

By downloading the CAD file I accept and agree to the [Terms and Conditions](#) of use.

Datasheets & Catalog Pages

[889759_3_Timer_Interconnection_System](#)

English