

Power connectors - SACC-M12FS-4CON-PG11-M PWR - 1404416

Please be informed that the data shown in this PDF Document is generated from our Online Catalog. Please find the complete data in the user's documentation. Our General Terms of Use for Downloads are valid (<http://phoenixcontact.com/download>)



Power connectors, 4-position, Socket straight M12, A-coded, Screw connection, knurl material: Zinc die-cast, nickel-plated, cable gland Pg11, external cable diameter 8 mm ... 10 mm

Your advantages

- ✓ Safe use in the field, thanks to a high degree of protection
- ✓ Flexible: connectors for on-site assembly
- ✓ Screw connection: proven connection technology for a large selection of different conductors



Key Commercial Data

Packing unit	1 pc
GTIN	 4 046356 694483
GTIN	4046356694483
Weight per Piece (excluding packing)	20.000 g
Custom tariff number	85366990
Country of origin	Germany

Technical data

Dimensions

Diameter housing	20 mm
Length	60.4 mm
External cable diameter	8 mm ... 10 mm
Stripping length of the sheath	20 mm
Stripping length of the individual wire	5 mm

Ambient conditions

Power connectors - SACC-M12FS-4CON-PG11-M PWR - 1404416

Technical data

Ambient conditions

Ambient temperature (operation)	-40 °C ... 85 °C (Plug / socket)
Degree of protection	IP67

General

Note	Strip 22 mm off the cable sheath, strip 7 mm off the conductor insulation, crimp the ferrule, then shorten this to 5 mm. Length of conductor with shortened ferrule: 20 mm. Connect conductors and tighten the mounting screws with 0.2 Nm.
	NOTE: Observe the permissible bending radii when laying conductors, since the degree of protection may be put in jeopardy if the bending forces are too high. Alleviate mechanical loads upstream of the connector, e.g. by using cable ties.
Rated current at 40°C	8 A (when using 1.5 mm ² conductors)
Rated voltage	250 V AC
	250 V DC
Number of positions	4
Color handle area	black
Insulation resistance	> 10 GΩ
Coding	A - standard
Standards/regulations	M12 connector IEC 61076-2-101
Status display	No
Overvoltage category	II
Degree of pollution	3
Connection method	Screw connection
Conductor cross section	0.75 mm ² ... 1.5 mm ² (without ferrule)
	0.75 mm ² ... 1.5 mm ² (with ferrule)
	0.75 mm ² ... 1.5 mm ² (solid)
Conductor cross section AWG	18 ... 16 (without ferrule)
	16 ... 18 (with ferrule)
Insertion/withdrawal cycles	≥ 100
Torque	0.4 Nm (M12 knurl)
	1.5 Nm ... 2 Nm (Pressure screw with sleeve housing)
	0.4 Nm (Screw plug insert with sleeve housing as far it will go)
	0.2 Nm (Screw terminal blocks)
Assembly instructions	The wires can be connected both with ferrules and without ferrules

Material

Flammability rating according to UL 94	V0
Contact material	CuZn
Contact surface material	Ni/Au

Power connectors - SACC-M12FS-4CON-PG11-M PWR - 1404416

Technical data

Material

Contact carrier material	PA
Material of grip body	PA
Material, knurls	Zinc die-cast, nickel-plated
Sealing material	Viton (M12 socket)
	NBR (Cable clamping)

Standards and Regulations

Standard designation	M12 connector
Standards/regulations	IEC 61076-2-101
Flammability rating according to UL 94	V0

Environmental Product Compliance

	Lead 7439-92-1
China RoHS	Environmentally Friendly Use Period = 50
	For details about hazardous substances go to tab "Downloads", Category "Manufacturer's declaration"

Drawings

Dimensional drawing

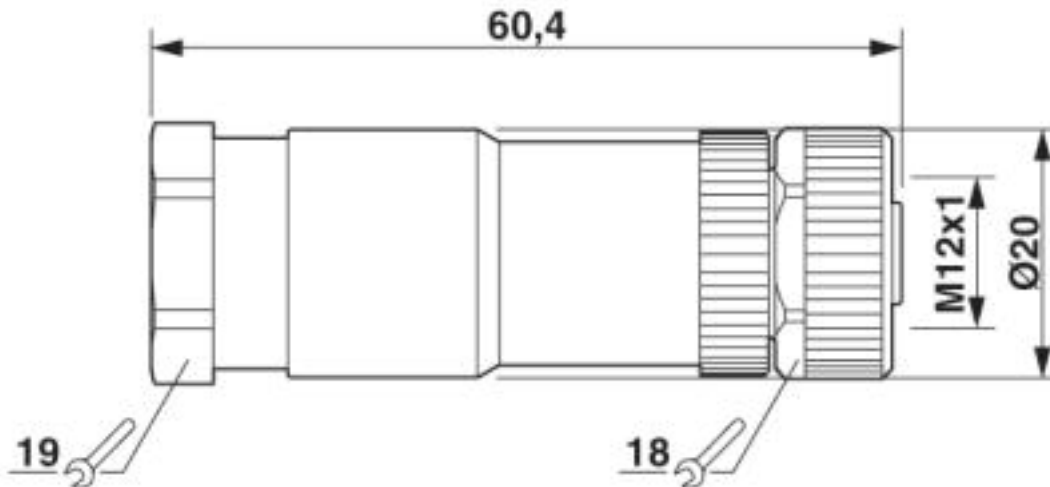

M12 x 1 socket, straight

Power connectors - SACC-M12FS-4CON-PG11-M PWR - 1404416

Schematic diagram

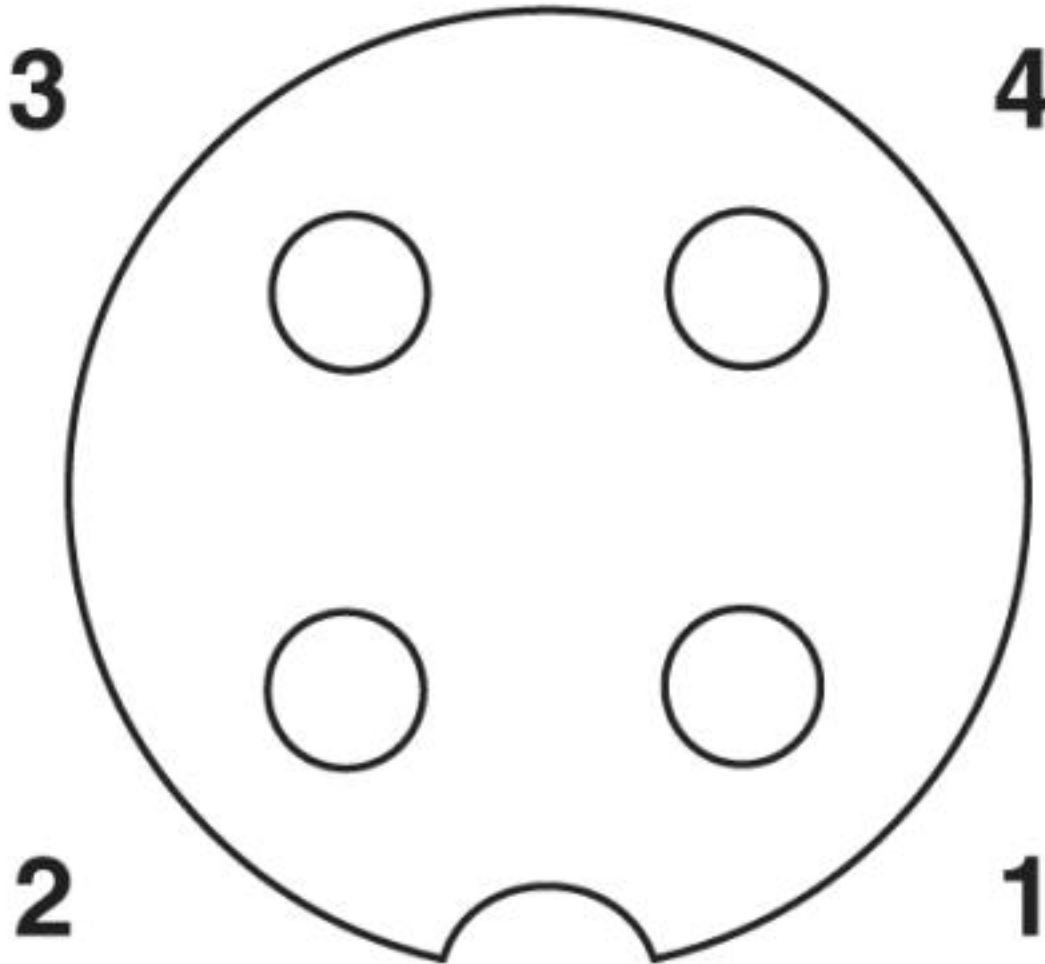

Pin assignment M12 socket, 4-pos., A-coded, view female side

Classifications

eCl@ss

eCl@ss 10.0.1	27440102
eCl@ss 4.0	27260700
eCl@ss 4.1	27260700
eCl@ss 5.0	27260700
eCl@ss 5.1	27260700
eCl@ss 6.0	27279200
eCl@ss 7.0	27440104

Power connectors - SACC-M12FS-4CON-PG11-M PWR - 1404416

Classifications

eCl@ss

eCl@ss 8.0	27440104
eCl@ss 9.0	27440102

ETIM

ETIM 2.0	EC001121
ETIM 3.0	EC002062
ETIM 4.0	EC002062
ETIM 5.0	EC002062
ETIM 6.0	EC002062

UNSPSC

UNSPSC 6.01	31251501
UNSPSC 7.0901	31251501
UNSPSC 11	31251501
UNSPSC 12.01	31251501
UNSPSC 13.2	39121413
UNSPSC 18.0	39121413
UNSPSC 19.0	39121413
UNSPSC 20.0	39121413
UNSPSC 21.0	39121413

Approvals

Approvals

Approvals

UL Recognized / cUL Recognized / EAC / cULus Recognized

Ex Approvals

Approval details

UL Recognized		http://database.ul.com/cgi-bin/XYV/template/LISEXT/1FRAME/index.htm	FILE E 221474
Nominal voltage UN	250 V		

Power connectors - SACC-M12FS-4CON-PG11-M PWR - 1404416

Approvals

Nominal current I _N	4 A
--------------------------------	-----

cUL Recognized		http://database.ul.com/cgi-bin/XYV/template/LISEXT/1FRAME/index.htm	FILE E 221474
Nominal voltage U _N	250 V		
Nominal current I _N	4 A		

EAC		RU C- DE.AI30.B.01102
-----	---	--------------------------

cULus Recognized	
------------------	---

Accessories

Accessories

Cable end sleeve

Ferrule - A 1,5 - 7 - 3200263



Ferrule, length: 7 mm, color: silver

Crimping tool

Crimping pliers - CRIMPFOX 6H - 1212046



Crimping pliers, for ferrules without insulating collar according to DIN 46228 Part 1 and ferrules with insulating collar according to DIN 46228 Part 4, 0.14 mm² ... 6 mm², unlockable pressure lock, lateral entry

Plug for cable screw gland

Power connectors - SACC-M12FS-4CON-PG11-M PWR - 1404416

Accessories

Screw plug - PROT-M12 MS-PA-CHAIN - 1430899

M12 sealing cap with fixing band, for sensor cables, for free M12 sockets



Screwdriver tools

Adapter insert - TSD-M SAC-BIT ADAPTER - 1212600



Adapter bit for TSD-M...torque tools, E6.3-1/4" drive with 4 mm hexagon to accommodate SAC bits

Tool - SACC BIT M12-D20 - 1208445



Nut for assembling M12 connectors for assembly with a knurl diameter of 20 mm, for 4 mm hexagonal drive

Screwdriver - SZF 1-0,6X3,5 - 1204517



Actuation tool, for ST terminal blocks, also suitable for use as a bladed screwdriver, size: 0.6 x 3.5 x 100 mm, 2-component grip, with non-slip grip

Stripping tool

Stripping tool - WIREFOX 6SC - 1212158



Stripping tool, for cables and conductors (especially for cables protected against short circuits and ground leakages) 1.5 - 6 mm², self-adjusting, stripping length of up to 18 mm, cutting capacity of up to 10 mm² stranded/1.5 mm² solid, replaceable stripping blade

Power connectors - SACC-M12FS-4CON-PG11-M PWR - 1404416

Accessories

Torque tool

Torque screwdriver - TSD 04 SAC - 1208429



Torque screwdriver, with preset torque of 0.4 Nm and 4 mm hexagonal drive for M12 connectors

Torque screwdriver - TSD-M 1,2NM - 1212224



Torque screw driver, accuracy as per EN ISO 6789 standard, adjustable from 0.3 - 1.2 Nm
