

Product data sheet

Specifications



Single contact block, Harmony XB4, Hamony XB5, silver alloy, compact push in terminals, 1 NC

ZBE1025

Product availability: Stock - Normally stocked in distribution facility

Main

Range of Product	Harmony XB5 Harmony XB4
Product or Component Type	Contact block
Device short name	ZBE
Sale per indivisible quantity	5
IP degree of protection	IP20 IEC 60529
Contact operation	Slow-break
Contact block type	Single
Contacts usage	Standard contacts
Connections - terminals	Push-in, $\leq 2 \times 1.5 \text{ mm}^2$ with wire end ferrule IEC 60947-1 Push-in, $\geq 1 \times 0.34 \text{ mm}^2$ without wire end ferrule IEC 60947-1

Complementary

CAD overall width	1.4 in (34.3 mm)
CAD overall height	0.6 in (14.8 mm)
CAD overall depth	0.4 in (9.8 mm)
Net Weight	0.011 lb(US) (0.005 kg)
Contacts type and composition	1 NC
Positive opening	With IEC 60947-5-1 appendix K
Operating travel	0.048 in (1.217 mm) NC changing electrical state) 0.2 in (4.3 mm) total travel)
Operating force	2.25 N NC changing electrical state
Mechanical durability	10000000 cycles
Contacts material	Silver alloy (Ag/Ni)
Short-circuit protection	10 A cartridge fuse gG IEC 60947-5-1
[Ith] conventional free air thermal current	10 A IEC 60947-5-1
[Ui] rated insulation voltage	300 V 3)IEC 60947-1
[Uimp] rated impulse withstand voltage	4 kV IEC 60947-1
[Ie] rated operational current	6 A 120 V, AC-15, A300 IEC 60947-5-1 3 A 240 V, AC-15, A300 IEC 60947-5-1 0.55 A 125 V, DC-13, Q300 IEC 60947-5-1 0.27 A 250 V, DC-13, Q300 IEC 60947-5-1
Mounting of block	Front mounting
Device presentation	Basic element

Price is "List Price" and may be subject to a trade discount – check with your local distributor or retailer for actual price.

Environment

Protective treatment	TH
Ambient Air Temperature for Storage	-40...158 °F (-40...70 °C)
Ambient Air Temperature for Operation	-40...158 °F (-40...70 °C)
Standards	IEC 60947-1 IEC 60947-5-1 IEC 60947-5-4 IEC 60947-5-5 UL 60947-1 UL 60947-5-1 UL 60947-5-5 UL 1059 UL 486E CSA C22.2 No 60947-1 CSA C22.2 No 60947-5-1 CSA C22.2 No 158 CSA C22.2 No 65 IACS E10
Product Certifications	EAC IECEE CB Scheme CCC UL CSA
Vibration resistance	5 gn (f= 10...500 Hz) conforming to IEC 60068-2-6 25 mm peak to peak (f= 2...10 Hz) conforming to IEC 60068-2-6
Shock resistance	25 gn 6 ms) 1000 shocks on each axis IEC 60068-2-27 30 gn 18 ms) half sine wave acceleration IEC 60068-2-27 50 gn 11 ms) half sine wave acceleration IEC 60068-2-27

Ordering and shipping details

Category	US10CS222469
Discount Schedule	0CS2
GTIN	3389119037433
Returnability	Yes
Country of origin	FR

Packing Units

Unit Type of Package 1	PCE
Number of Units in Package 1	1
Package 1 Height	1.30 in (3.3 cm)
Package 1 Width	2.05 in (5.2 cm)
Package 1 Length	1.65 in (4.2 cm)
Package 1 Weight	0.2 oz (5 g)
Unit Type of Package 2	BB1
Number of Units in Package 2	5
Package 2 Height	1.30 in (3.3 cm)
Package 2 Width	2.05 in (5.2 cm)
Package 2 Length	1.65 in (4.2 cm)
Package 2 Weight	1.06 oz (30 g)
Unit Type of Package 3	S02
Number of Units in Package 3	500

Package 3 Height	5.91 in (15 cm)
Package 3 Width	11.81 in (30 cm)
Package 3 Length	15.75 in (40 cm)
Package 3 Weight	7.308 lb(US) (3.315 kg)

Contractual warranty

Warranty	18 months
-----------------	-----------



Environmental Data

Schneider Electric aims to achieve Net Zero status by 2050 through supply chain partnerships, lower impact materials, and circularity via our ongoing “Use Better, Use Longer, Use Again” campaign to extend product lifetimes and recyclability.

[Environmental Data explained >](#)

[How we assess product sustainability >](#)

Environmental footprint

Carbon footprint (kg CO2 eq, Total Life cycle) 1

Environmental Disclosure [Product Environmental Profile](#)

Use Better

Materials and Substances

Packaging made with recycled cardboard Yes

Packaging without single use plastic Yes

[EU RoHS Directive](#) Pro-active compliance (Product out of EU RoHS legal scope)

REACH Regulation [REACH Declaration](#)

California proposition 65 **WARNING:** This product can expose you to chemicals including: Di-isodecyl phthalate (DIDP), which is known to the State of California to cause birth defects or other reproductive harm. For more information go to www.P65Warnings.ca.gov

Use Again

Repack and remanufacture

Circularity Profile [End of Life Information](#)

Take-back No

WEEE  The product must be disposed on European Union markets following specific waste collection and never end up in rubbish bins.

Dimensions Drawings

Dimensions

with ZB5AZ009 Fixing Collar

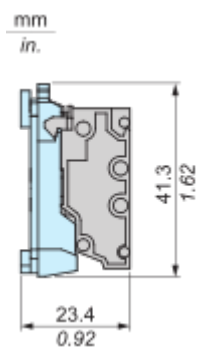

with ZB4BZ009 Fixing Collar

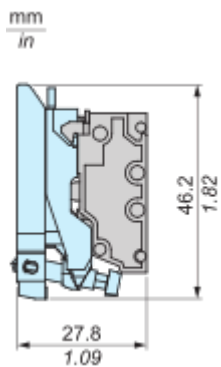

Mounting and Clearance

Mounting

Mounting and Unmounting

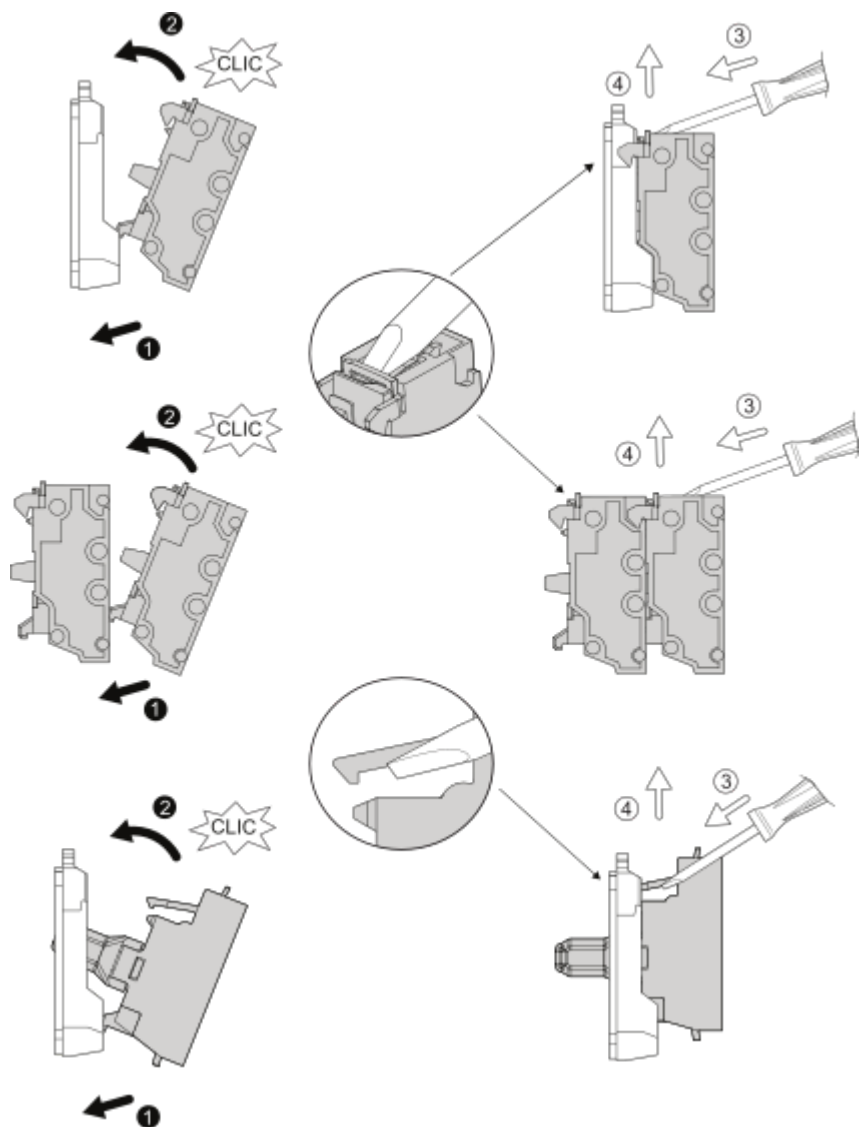

Panel cut-out Dimension

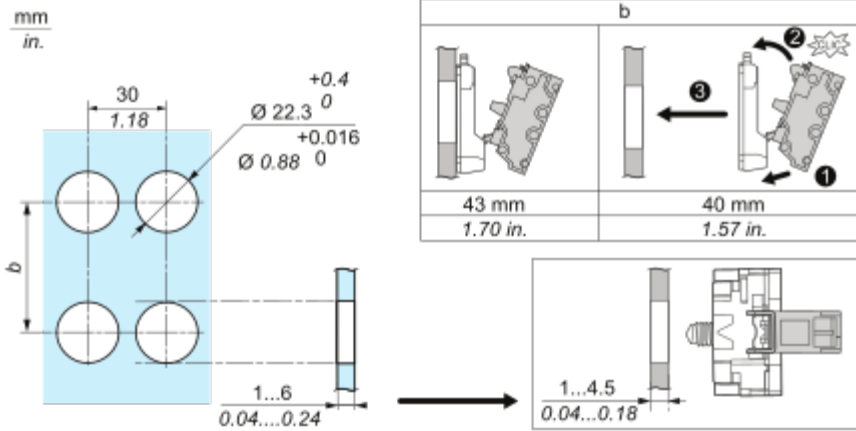

Connections and Schema

Wiring

Wiring and Unwiring

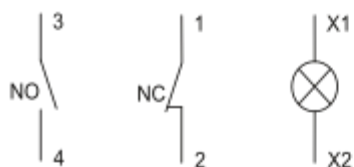

mm	8
in.	0.32
mm ²	0.34...1.5
AWG	22...16

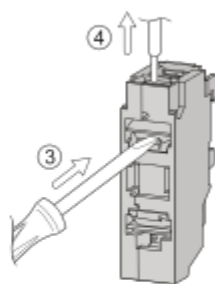
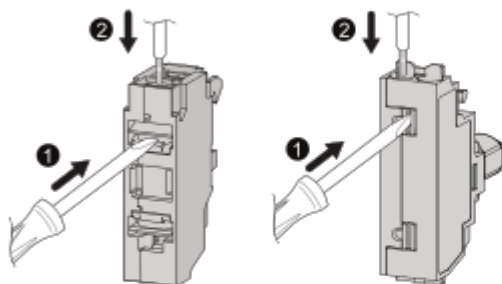
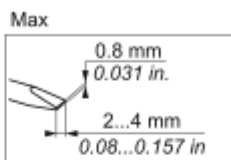

mm	8	8	8
in.	0.32	0.32	0.32
mm ²	0.34...1.5	0.34...1	0.34...1.5
AWG	22...16	22...18	22...16

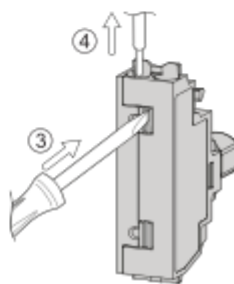
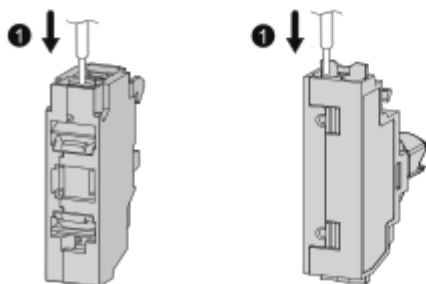

Technical Illustration

Dimensions

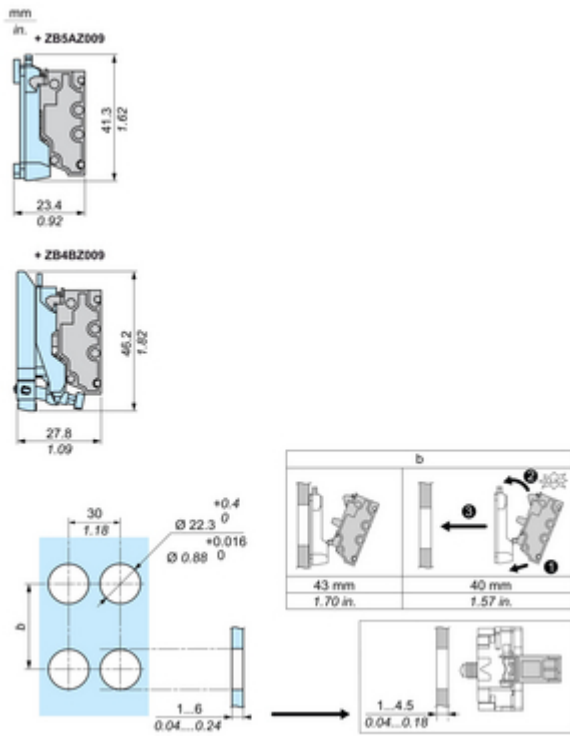

Technical Illustration

Wiring diagram

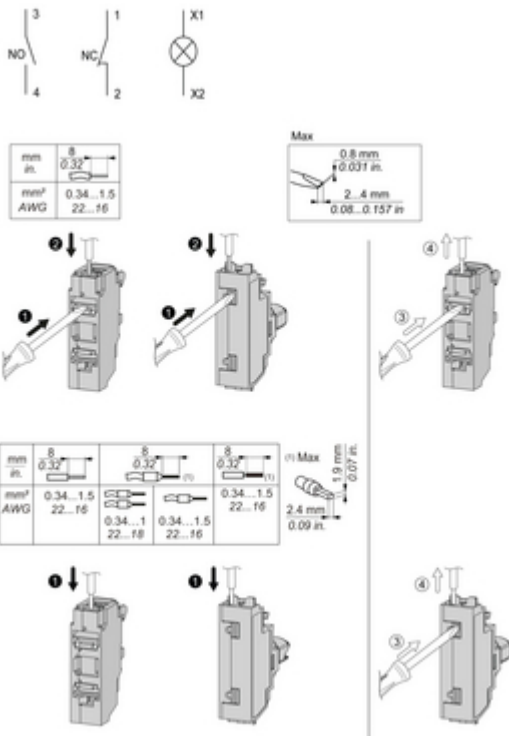

Offer Marketing Illustration

Product benefits / Features

Technical Benefits

Harmony XB4/XB5 Compact Push-in blocks

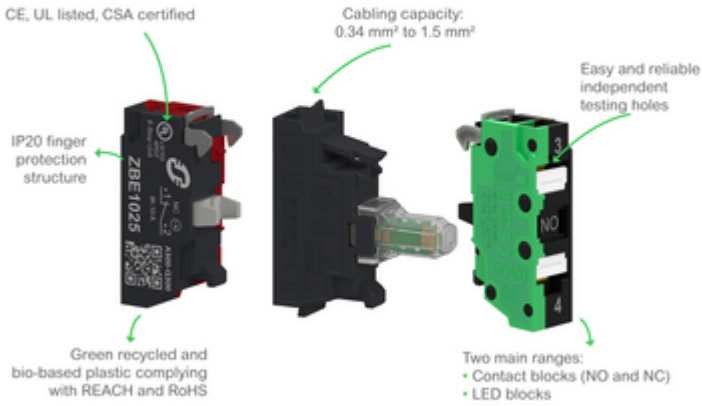

Offer Marketing Illustration

Product benefits / Features

Features
Harmony XB4/XB5 Compact Push-in blocks



37% thinner than a standard block

Installation costs saved through reduced wiring time and effort

Fully compatible with current Harmony offer

Available as single block, sub-assemblies and complete units (both plastic and metal ranges)

Simplified inventory management

Image of product / Alternate images

Alternative





